

**ESTIMATING
&
COST EVALUATION-II**

TH-5

5th SEM

CIVIL ENGG.

Under SCTE&VT,Odisha

PREPARED BY:-



Er.SADEQA KHATUN

LECTURER,Dept of CIVIL,

KALINGA NAGAR POLYTECHNIC.TARAPUR,JAJPUR ROAD

Detailed estimate of Road:

Estimate of road (Earth work): →

→ cross section of earthwork of road in cutting or in banking is usually in the form of trapezium and the quantity of earth work may be calculated by following method.

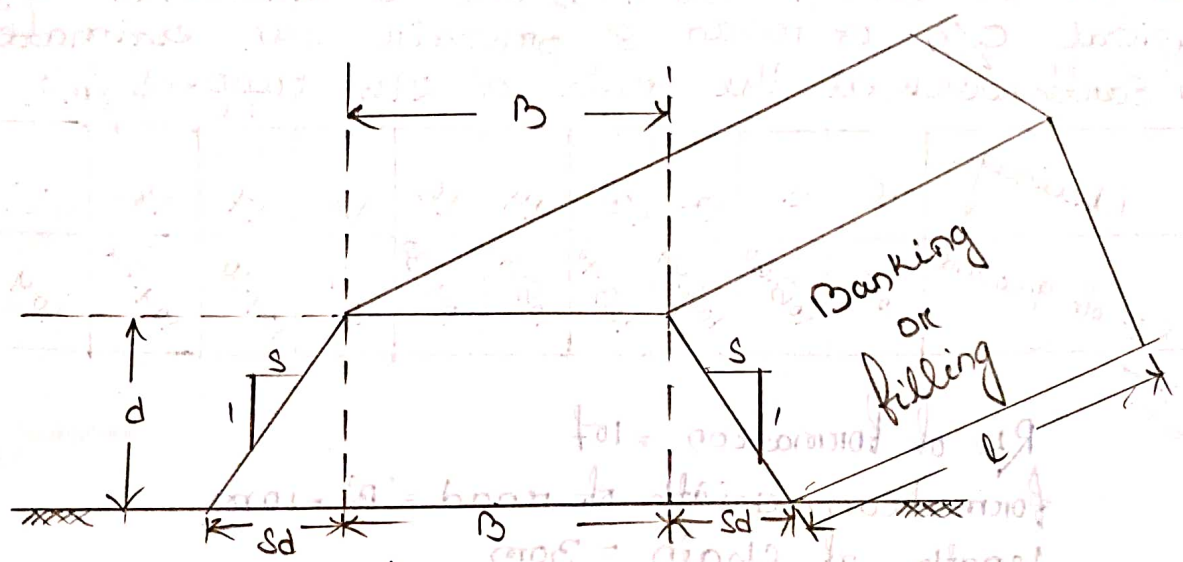

let,

- B = Breadth of surface
- d = Depth of banking or filling
- s = slope
- S:1 = means S = Horizontal
1 = Vertical

Here 1v = S horizontal
dv = sd horizontal
l = length of road

Quantity of volume = c/s area x length

c/s area = Area of central rectangular portion + 2 x Area of triangular portion

$$= Bd + \frac{1}{2} \times sd \times d + \frac{1}{2} \times sd \times d$$

$$= Bd + \frac{1}{2} sd^2 + \frac{1}{2} sd^2$$

$$= Bd + sd^2$$

quantity of earth work = Area x length
= $(Bd + sd^2) \times L \text{ m}^3$

height of Bank = RL of formation - RL of ground

Prob-1 The RL of ground along the centreline of a road from chainage 10 to 20 are given below the RL of formation at the 10th chainage is 107 and road is in down ward gradient of 1 in 150 up to chainage 14 then the gradient changes to 1 in 100 downward. formation width of road is 10m and side slopes of banking are 2:1 (Horizontal : vertical)

length of chain = 30m. Draw longitudinal c/s and typical c/s of road & prepare an estimate of Earthwork at the rate of 275 rupees/m³.

Chainage	10	11	12	13	14	15	16	17	18	19	20
RL of ground	105	105.60	105.44	105.90	105.42	104.30	105	104.10	104.62	104	103.33

Solⁿ:

RL of formation = 107

formation width of road = 'B' = 10m

length of chain = 30m

downward gradient 1 in 150 upto chainage 14

1 vertical = 150 horizontal

$$\Rightarrow 150 = 1V.$$

1 horizontal = $\frac{1}{150}$ vertical

30 horizontal = $\frac{1}{150} \times 30V = 0.2$ vertical

gradient \rightarrow Downward gradient 1 in 100 upto chainage 20

100 horizontal = 1 vertical

$$1h = \frac{1}{100} V.$$

$$30h = \frac{1}{100} \times 30V = 0.3V$$

Longitudinal cross section of road:

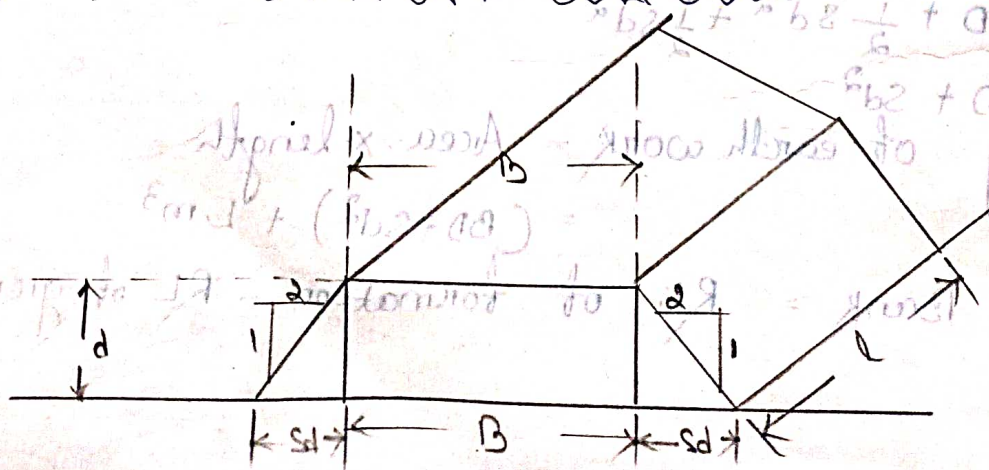

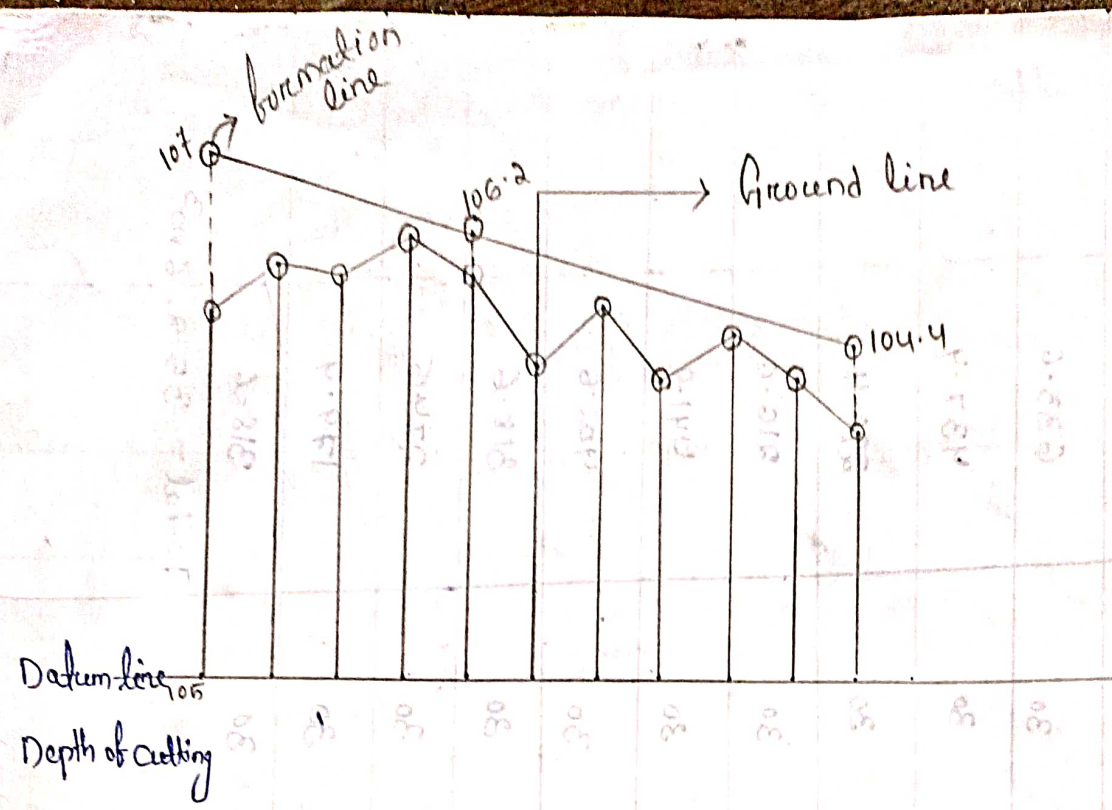

Distance Chainage	10	11	12	13	14	15	16	17	18	19	20
Distance	800	330	360	390	420	450	480	510	540	570	600
RL of ground	105.0	105.60	105.44	105.96	105.42	104.30	105.0	104.10	104.62	104.0	103.83
RL of formation	107.0	106.8	106.6	106.4	106.2	105.90	105.60	105.30	105.0	104.70	104.4
Depth of filling	2.0	1.2	0.8	0.5	0.8	1.6	0.6	1.2	0.6	0.7	0.6
Depth of cutting	30	30	30	30	30	30	30	30	30	30	30

Handwritten notes and calculations on the grid background, including various numbers and symbols.

Sl. No.	Length (m)	Depth of cutting (m)	Mean width (m)	Central Area (m ²)	Side Area (m ²)	Total Area (m ²)	Depth of station	Quantity (Banking + Cobbling)
10	300	0.0	—	—	—	—	—	—
11	350	1.2	$\frac{2+11.2}{2} = 1.6$	$10 \times 1.6 = 16$	$2 \times (1.6^2) = 5.12$	$16 + 5.12 = 21.12$	30	633.6
12	360	1.16	1.18	11.8	2.784	14.58	30	437.4
13	390	0.6	0.83	8.3	$1.377 \Rightarrow 10.38$	9.68	30	290.4
14	400	0.84	0.64	6.4	$0.819 \Rightarrow 0.82$	7.22	30	216.6
15	400	1.6	1.19	11.9	2.832	14.73	30	441.9
16	450	0.6	1.1	11	2.42	13.42	30	402.6
17	510	1.2	0.9	9	1.62	10.62	30	318.6
18	500	0.8	0.79	9	$1.248 \Rightarrow 1.25$	9.15	30	274.5
19	570	0.7	0.64	4	0.58	5.98	30	179.4
20	600	1.1	0.9	9	1.62	10.62	30	318.6
Total = 3513.6 m ³								

for 1 m³ rate = 275/-
 for 3513.6 m³ = 3513.6 x 275 = 966240/- (Ans)

Prq-2 Estimate the quantity of Earthwork for a portion of road for 700m length from the following data:==

Formation width = 10m

Slopes in cutting = 1:1

Slopes in filling = 2:1

formation level at 0 chainage = 104

Downward gradient 1 in 100.

Distance	0	100	200	300	400	500	600	700	X
RL of ground	100.5	102.8	99.2	103.6	104.5	106.5	105.3	105.0	X

Sol:

Formation B = 10m.

RL of formation 'o' = 104

Side slope filling = 2:1 = 2:1

cutting = 1:1 = 1:1

Gradient \rightarrow downward gradient 1 in 100

that means $100h = 1v$

$1h = 1/100v$

$100h = 100/100 = 1 \text{ vertical}$

Longitudinal c/s of road:

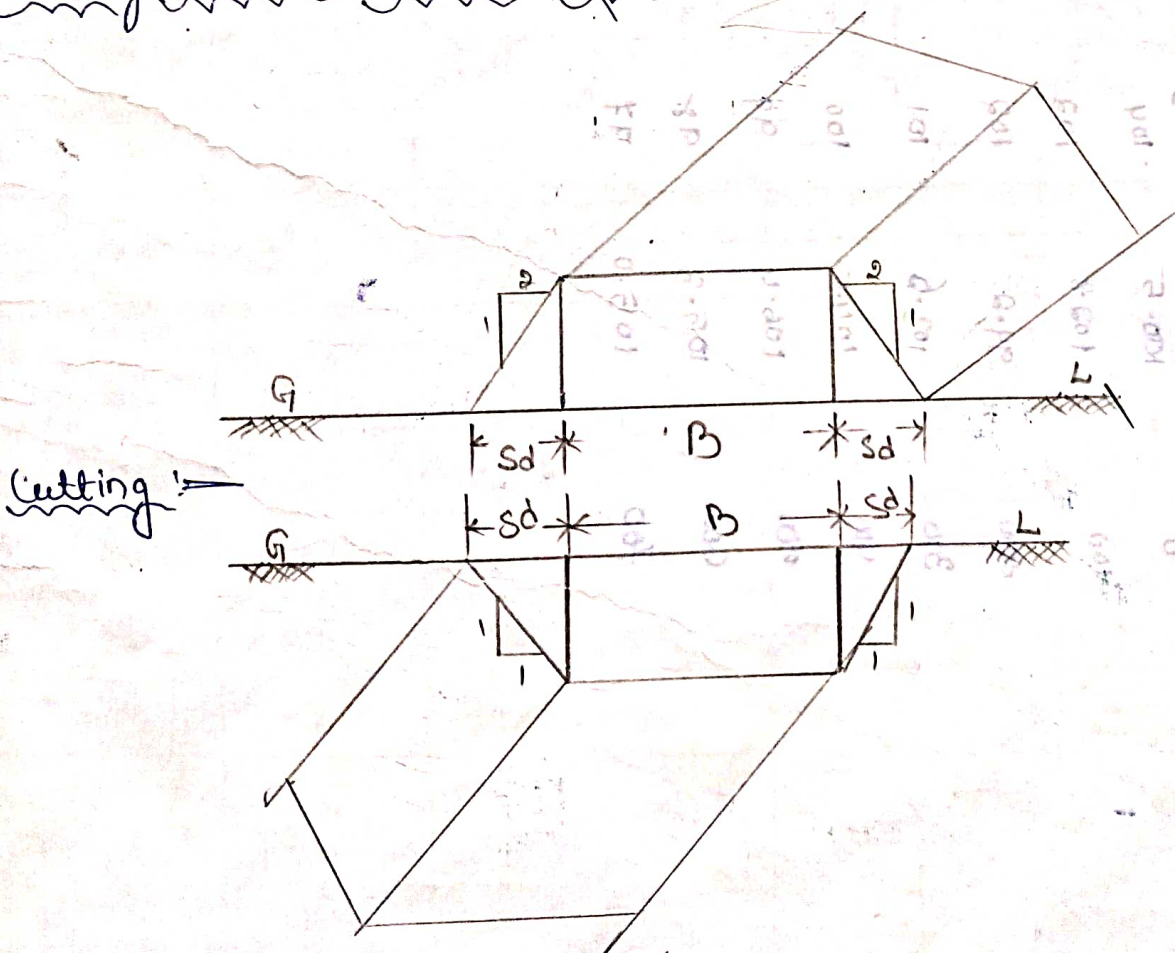

Dateline

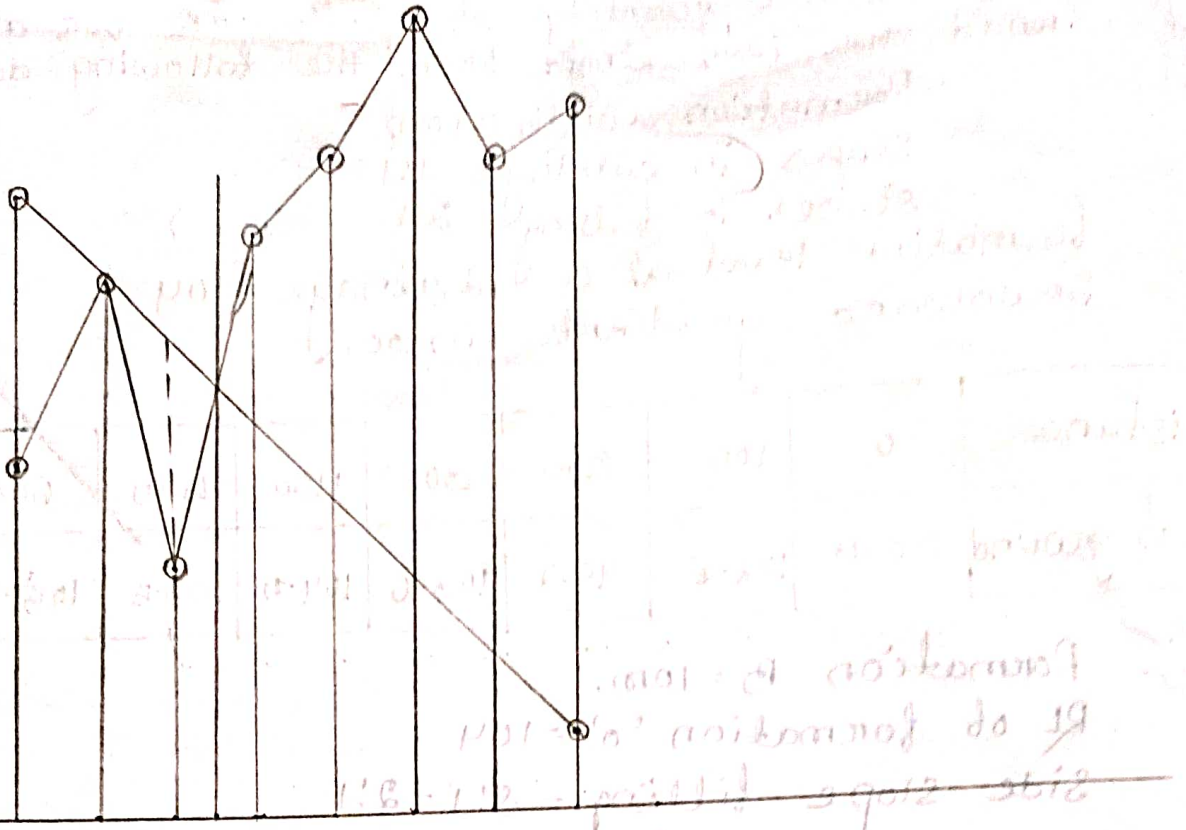

Depth of cutting

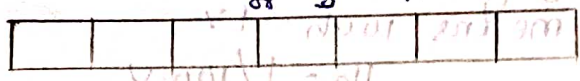

Depth of filling

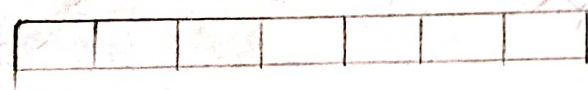

RL of formation

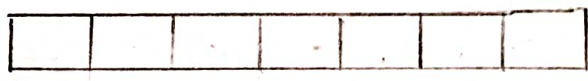

RL of ground

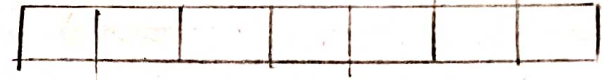

Distance

Change

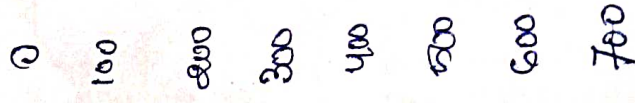

Unit

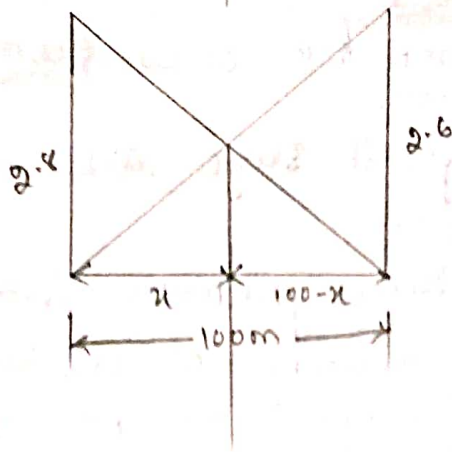

$$\Rightarrow \frac{2.8}{x} = \frac{2.6}{100-x}$$

$$\Rightarrow 2.8(100-x) = 2.6x$$

$$\Rightarrow -2.8x + 280 = 2.6x$$

$$\Rightarrow 280 - 2.8x = 2.6x$$

$$\Rightarrow 280 = 2.6x + 2.8x$$

$$\Rightarrow 280 = 5.4x$$

$$x = \frac{280}{5.4} = 51.85$$

$$x = 51.85$$

$$100 - 51.85$$

$$= 48.15$$

Chainage	Length m	Height or depth of cutting or banking (m)	Mean height or depth (m)	Central area $B D m^2$	Side area $S d^2$	Total area $(B D + S d) m^2$	Length in bet. station	Quantity Banking $(B D) \times L$	Cutting
0	0	3.5	—	—	—	—	—	—	—
1	100	0.2	$\frac{3.5+0.2}{2} = 1.85$	$10 \times 1.85 = 18.5$	$2 \times (1.85)^2 = 6.845$	$18.5 + 6.845 = 25.345$	100	2534	
2	200	2.8	1.5	15	4.5	19.5	100	1950	
Passes	251.85	0	1.4	14	3.92	17.92	51.85	929.152	
3	300	-2.6	1.3	13	$1 \times (1.3)^2 = 1.69$	14.69	48.15		707.32
4	400	-4.5	3.55	35.5	12.60	48.1	100		4810
5	500	-7.4	5.95	59.5	35.40	94.9	100		9490
6	600	-7.3	7.35	73.5	54.02	127.52	100		12752
7	700	-8	7.65	76.5	58.52	135.02	100		13502
Total =								+5414.15m ³	-41261.32m ³
Total banking = 5414.15m ³ Total cutting = -41261.32m ³ use (-ve sign for cutting) (Ans).									

Pro-3

workout the earthwork for road from the following data
 formation width = 9.5m.

Banking/ Embankment slope = 2:1

Cutting slope = 1.5:1

The formation are filling gradient = 1 in 200

RL of formation at chainage '0' = 102.50

Distance	0	20	40	60	80	100	120	X
RL of ground	101.76	101.5	101.8	101.75	101.9	101.86	101.85	X

Sol 7

Formation width = B = 9.5m

RL of formation at '0' = 102.50

Embankment s:1 = 2:1

Cutting s:1 = 1.5:1

Gradient - downward gradient 1 in 200

$$200h = 1ve$$

$$1h = \frac{1}{200} v$$

$$20h = 20/200 v = 0.1v$$

Longitudinal c/s of road

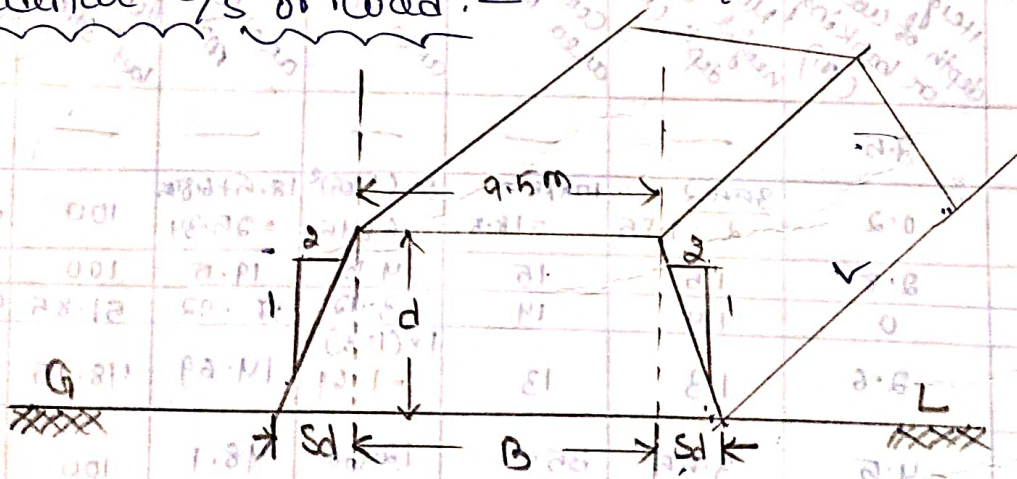

Typical c/s of Road

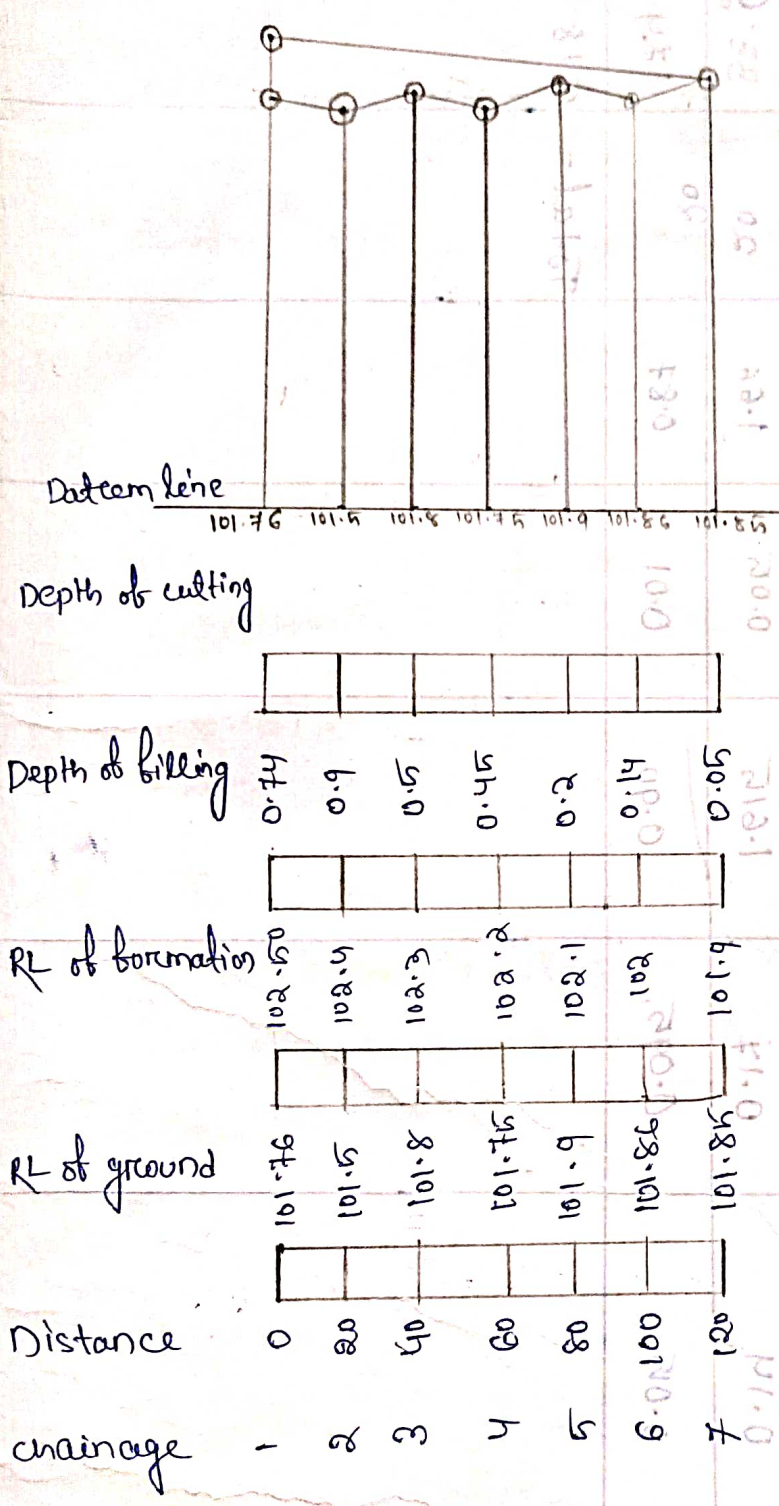

1	0	101.76	102.50	0.74	0.00	102.50	0.74	0.00	0.00	0.00	0.00	0.00	0.00	0.00	0.00	0.00	0.00	0.00	0.00
2	20	101.5	102.4	0.9	0.00	102.4	0.9	0.00	0.00	0.00	0.00	0.00	0.00	0.00	0.00	0.00	0.00	0.00	0.00
3	40	101.8	102.3	0.5	0.00	102.3	0.5	0.00	0.00	0.00	0.00	0.00	0.00	0.00	0.00	0.00	0.00	0.00	0.00
4	60	101.75	102.2	0.45	0.00	102.2	0.45	0.00	0.00	0.00	0.00	0.00	0.00	0.00	0.00	0.00	0.00	0.00	0.00
5	80	101.9	102.1	0.2	0.00	102.1	0.2	0.00	0.00	0.00	0.00	0.00	0.00	0.00	0.00	0.00	0.00	0.00	0.00
6	100	101.86	102.0	0.14	0.00	102.0	0.14	0.00	0.00	0.00	0.00	0.00	0.00	0.00	0.00	0.00	0.00	0.00	0.00
7	120	101.85	101.9	0.05	0.00	101.9	0.05	0.00	0.00	0.00	0.00	0.00	0.00	0.00	0.00	0.00	0.00	0.00	0.00
8	140	101.8	101.8	0.0	0.00	101.8	0.0	0.00	0.00	0.00	0.00	0.00	0.00	0.00	0.00	0.00	0.00	0.00	0.00
9	160	101.7	101.7	0.0	0.00	101.7	0.0	0.00	0.00	0.00	0.00	0.00	0.00	0.00	0.00	0.00	0.00	0.00	0.00
10	180	101.6	101.6	0.0	0.00	101.6	0.0	0.00	0.00	0.00	0.00	0.00	0.00	0.00	0.00	0.00	0.00	0.00	0.00
11	200	101.5	101.5	0.0	0.00	101.5	0.0	0.00	0.00	0.00	0.00	0.00	0.00	0.00	0.00	0.00	0.00	0.00	0.00
12	220	101.4	101.4	0.0	0.00	101.4	0.0	0.00	0.00	0.00	0.00	0.00	0.00	0.00	0.00	0.00	0.00	0.00	0.00
13	240	101.3	101.3	0.0	0.00	101.3	0.0	0.00	0.00	0.00	0.00	0.00	0.00	0.00	0.00	0.00	0.00	0.00	0.00
14	260	101.2	101.2	0.0	0.00	101.2	0.0	0.00	0.00	0.00	0.00	0.00	0.00	0.00	0.00	0.00	0.00	0.00	0.00
15	280	101.1	101.1	0.0	0.00	101.1	0.0	0.00	0.00	0.00	0.00	0.00	0.00	0.00	0.00	0.00	0.00	0.00	0.00
16	300	101.0	101.0	0.0	0.00	101.0	0.0	0.00	0.00	0.00	0.00	0.00	0.00	0.00	0.00	0.00	0.00	0.00	0.00
17	320	100.9	100.9	0.0	0.00	100.9	0.0	0.00	0.00	0.00	0.00	0.00	0.00	0.00	0.00	0.00	0.00	0.00	0.00
18	340	100.8	100.8	0.0	0.00	100.8	0.0	0.00	0.00	0.00	0.00	0.00	0.00	0.00	0.00	0.00	0.00	0.00	0.00
19	360	100.7	100.7	0.0	0.00	100.7	0.0	0.00	0.00	0.00	0.00	0.00	0.00	0.00	0.00	0.00	0.00	0.00	0.00
20	380	100.6	100.6	0.0	0.00	100.6	0.0	0.00	0.00	0.00	0.00	0.00	0.00	0.00	0.00	0.00	0.00	0.00	0.00
21	400	100.5	100.5	0.0	0.00	100.5	0.0	0.00	0.00	0.00	0.00	0.00	0.00	0.00	0.00	0.00	0.00	0.00	0.00
22	420	100.4	100.4	0.0	0.00	100.4	0.0	0.00	0.00	0.00	0.00	0.00	0.00	0.00	0.00	0.00	0.00	0.00	0.00
23	440	100.3	100.3	0.0	0.00	100.3	0.0	0.00	0.00	0.00	0.00	0.00	0.00	0.00	0.00	0.00	0.00	0.00	0.00
24	460	100.2	100.2	0.0	0.00	100.2	0.0	0.00	0.00	0.00	0.00	0.00	0.00	0.00	0.00	0.00	0.00	0.00	0.00
25	480	100.1	100.1	0.0	0.00	100.1	0.0	0.00	0.00	0.00	0.00	0.00	0.00	0.00	0.00	0.00	0.00	0.00	0.00
26	500	100.0	100.0	0.0	0.00	100.0	0.0	0.00	0.00	0.00	0.00	0.00	0.00	0.00	0.00	0.00	0.00	0.00	0.00

Handwritten notes and calculations on the right side of the page, including:

- Formulas for calculating cutting and filling volumes.
- References to 'Depth of cutting' and 'Depth of filling'.
- Notes about 'RL of formation' and 'RL of ground'.
- Calculations for 'Distance chainage'.
- Additional numerical values and annotations.

Charge	Length (m)	Height or cutting or banking (m)	mean width or depth (m)	central area (sq m)	side area (sq m)	total area (sq m)	Length in meters	Quantity (Banking or Cutting)
0	0	0.74	—	—	—	—	—	—
1	20	0.9	$\frac{0.74 + 0.9}{2} = 0.82$	$6.77 = 2 \times 0.82 \times 9.13$	$2 \times (0.82) \times 9.13 = 1.34$	9.13	20	182.6
2	40	0.5	0.7	6.95	0.98	7.63	20	152.6
3	60	0.5	0.7	9.46	0.44	4.9	20	86
4	80	0.2	0.32	3.04	0.20	3.24	20	64.8
5	100	0.14	0.17	1.65	0.05	1.66	20	33.6
6	120	0.05	0.095	0.60	0.01	0.61	20	12.2
Total =								648.4 m ³

Area of side sloping surface:

The area of sides may required leveling or pitching may be found by multiplying the mean sloping breadth by the length.

The mean sloping breadth =

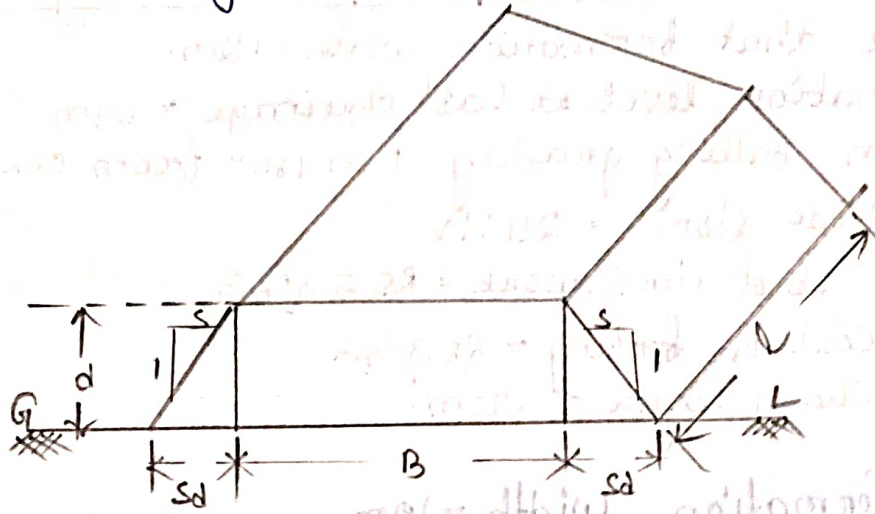

$$\sqrt{d^2 + s^2} d$$

$$= \sqrt{d^2(1+s^2)}$$

$$= d\sqrt{1+s^2}$$

$$\text{Area of one side slope} = L \times d\sqrt{1+s^2}$$

$$\text{Area of both side slope} = 2Ld\sqrt{1+s^2}$$

Tabulation:

Station or chainage	depth of height (m)	mean depth (m)	Breadth of side slope $\frac{d\sqrt{1+s^2}}{m}$	length in bet ⁿ station (m)	Total area of both side slope $2Ld\sqrt{1+s^2}$ (m ²)

Prob-1 Calculate the cost of earthwork & torbing for a portion of a National highway for the following data.

chainage	0	1	2	3	4
RL of ground	62.00	61.40	61.70	61.5	60.8

Assume that formation width = 12m.

formation level at last chainage = 64m

uniform balling grading 1 in 180 from chainage 0 to 4.

Side slope = 2H:1V

Cost of earthwork = Rs 53/m³.

Cost of torbing = Rs 3/m²

Chain length = 120m.

Solⁿ

Formation width = 12m

1 in 180

$$180h = 1v$$

$$1h = \frac{1}{180}v$$

$$120h = \frac{120}{180}v = 0.66v.$$

Longitudinal c/s of Road:

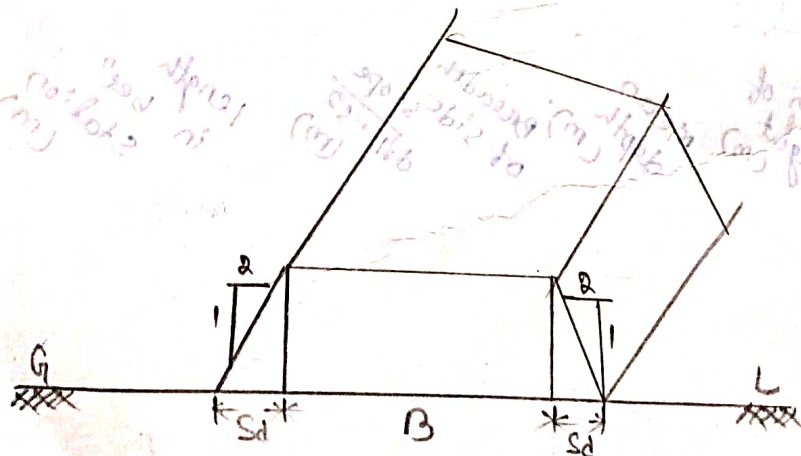

Typical c/s

Datum line

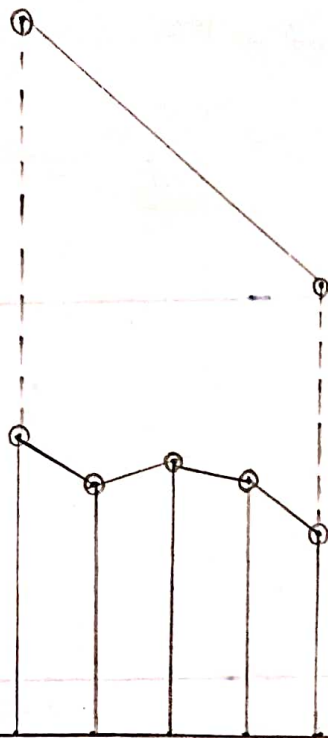

10000 - 10000

Depth of cutting

--	--	--	--	--

Depth of billing

4.64	4.58	3.62	3.16	3.2
------	------	------	------	-----

RL of formation

--	--	--	--	--

66.64	65.98	65.32	64.66	64
-------	-------	-------	-------	----

RL of ground

--	--	--	--	--

62.00	61.40	61.70	61.5	60.8
-------	-------	-------	------	------

Distance

--	--	--	--	--

Chainage

0	1	2	3	4
---	---	---	---	---

1	2	3	4	5
38	31.8	30.8	27.1	24.3
11.1	4.24	4.16	10.30	
31.8	30.8	27.1	24.3	
62.00	61.40	61.70	61.5	60.8
38	31.8	30.8	27.1	24.3

Station or Chaugage	Depth or height (m)	mean depth (m)	Breadth sideslope $d\sqrt{1+s^2}$ (m)	Length in base Station (m)	Total area of both Side slope $2\sqrt{1+s^2} (m)^2$
0	4.64	—	—	—	—
1	4.58	4.61	10.30	120	2472
2	3.62	4.1	9.16	120	2198.4
3	3.16	3.39	7.58	120	1819.2
4	3.2	3.18	7.11	120	1706.4
				Total =	8196 m ²

1 m² turbing Rate = 3/-
 8196 m² turbing = 8196 x 3
 = 24588/-

Distance
 of bearing
 not found to
 center of bearing
 right to slope
 and marked

Chainage	Depth (m)	Height or depth of cutting or banking (m)	mean width or depth (m)	Central Area (m ²)	Side Area (m ²)	Total Area (m ²)	Depth in Bank (m)	Quantity (Banking) x L	Quantity (Cutting) x L	
0	0	4.64	—	—	—	—	—	—	—	
1	120	4.58	4.61	$12 \times 4.61 = 55.32$	$2 \times (4.61^2) = 42.50$	97.82	120	11738.4	—	
2	240	3.62	4.1	49.2	33.62	82.82	120	9938.4	—	
3	360	3.16	3.39	40.68	22.98	63.66	120	7639.2	—	
4	480	3.2	3.18	38.16	20.22	58.38	120	7005.6	—	
								Total =	36321.6 m ³	

$1 \text{ m}^3 \text{ earthwork rate} = 53/-$
 $36321.6 \text{ m}^3 \text{ earthwork} = 36321.6 \times 53$
 $= 1925044.8/-$

Total cost = $24588 + 1925044.8$
 $= 1949632.8 /- \text{ (Ans)}$

Estimate of water bound macadam road:

(Estimate of WBM road):

Q.1 Estimate the items of construction of a WBM road from the following data: →

length of road := 100m.

metal width := 5500mm.

thickness of grade I metal = 80mm

wearing coat of grade II metal = 120mm loose consolidated to 80mm thick

surface of the road is to be finished with 2 coats bitumine as given below.

1st coat = 12mm chips @ 0.018 m^3 & bitumen @ 1.22kg per sqm of road surface.

2nd coat = 6mm chips @ 0.01 m^3 & bitumen @ 1.22kg per sqm of the road surface.

Consumption of fuel @ 0.4 kg/kg of bitumen.

Sol.:

length of road = 100m

metal width = 5500mm

thickness of grade I metal = 80mm

1st Coat = chips = $0.018 \text{ m}^3/\text{m}^2$

Bitumen = $1.22 \text{ kg}/\text{m}^2$

2nd coat = chips = $0.01 \text{ m}^3/\text{m}^2$

Bitumen = $1.22 \text{ kg}/\text{m}^2$

fuel = 0.4 kg/kg .

Sl. No	P.O.I	No	L	B	D	Q	Expl ⁿ note
1	site clearance	1	100 m	6.7 m		670	$B = 15.5 + 0.6 + 0.6 = 6.7$
2	<u>Metal soling</u>						
	grade = I	1	100 m	5.5 m	0.08	44 m ³	
	grade = II	1	100 m	5.5 m	0.12	66 m ³	
3	<u>Chips</u>						
	12mm size chips	1	100 m	5.5	0.018	9.9	
	6mm size chips	1	100 m	5.5	0.01	5.5	
4	<u>Bitumen</u>						
	1st coat	1	100	5.5	1.22	671 kg	
	2nd coat	1	100	5.5	1.22	671 kg	

Total bitumen = 671 + 671 = 1342 kg
 for 1 kg bitumen fuel required = 0.4 kg
 for 1342 kg bitumen required fuel = 1342 × 0.4 = 536.8 kg.

Q-2 Estimate the following quantities for construction of a WBM road for 1 km length having following specification.

Formation width of road = 10 m.

Average height of bank = 1 m.

Side slope of bank = 2:1

metal width of road = 3.8 m.

Soling coat of over burnt brick = 10 cm. thick

inter coat of metaling shall be of stone balast

12 cm thick loose compacted to 8 cm.

Top coat of metaling shall be stone ballast of 9cm thick loose layer compacted to 6cm.

Bitumen @ 2.2kg persqm for both inter & top coat.

- (i) Earth work in excavation.
- (ii) No of brick for soling
- (iii) Metal soling.
- (iv) Quantity of bitumen

Solⁿ

Data given:

length of road = 1km.

formation width = 10m.

height of bank = 1m.

Side slope of bank = 2:1

metal width of road = 3.8m.

Soling coat of over burnt brick = 10cm thick

Inter Coat ballast = 12cm thick

Top coat ballast = 9cm thick

Inter coat of bitumen = 2.2 kg/sqm.

Top coat bitumen = 2.2 kg/sqm.

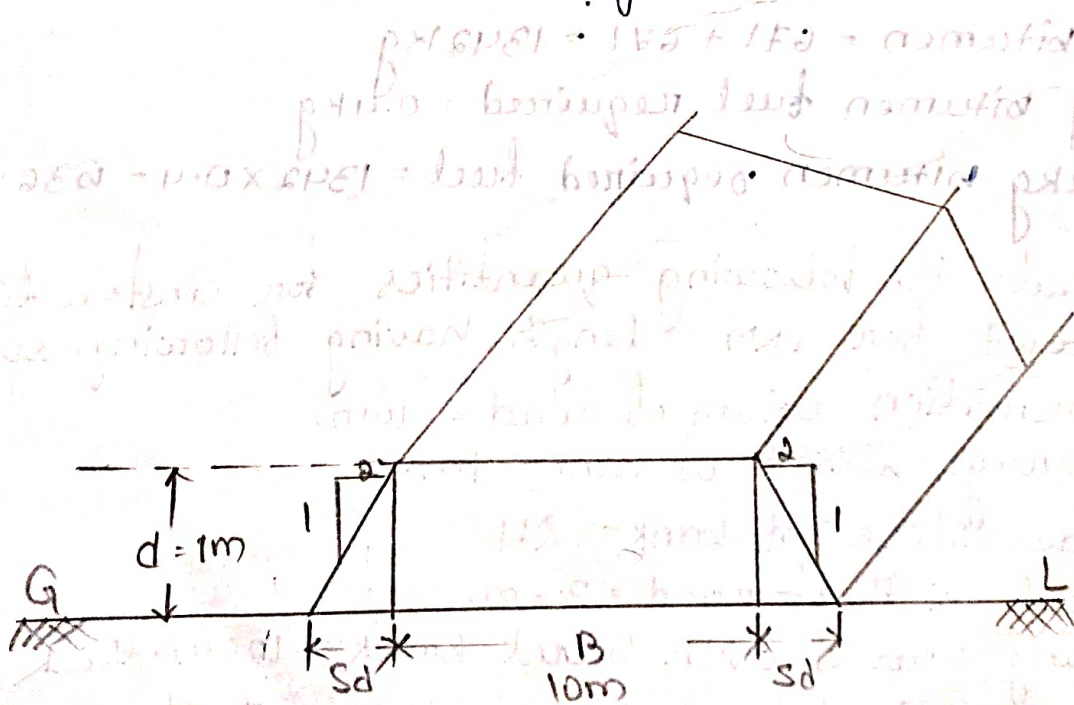

(i) Earthwork in excavation =

Quantity of earth work
 = Area of road surface \times length of road
 $(bd + sd^2) \times L$
 $= (10 \times 1 + 2 \times 1^2) \times 1$
 $= 12m^2$

(ii) No of brick for soling :-

P.O.D	NO	L	B	D	Q	Explan note
Brick Soling	1	1000m	3.8m	0.1m	380m ³	

Volume of 1 brick = $0.2 \times 0.1 \times 0.1 = 0.002m^3$
 No of bricks = $\frac{380m^3}{0.002} = 190,000$ nos

(iii) Metal soling :-

P.O.D	NO	L	B	D	Q	Explan Note
Metal Soling						
Inter coat	1	1000m	3.8m	0.12m	456m ³	
Top coat	1	1000m	3.8m	0.09m	342m ³	
					Total = 798m ³	

(iv) Quantity of bitumen :-

P.O.D	NO	L	B	D	Q	Explan Note
Bitumen						
Inter coat	1	1000m	3.8m	2.2kg/12m	8360kg	
Top coat	1	1000m	3.8m	2.2kg/12m	8360kg	
					Total = 16720kg	

Q-3 Estimate the items of construction of a WBM road for the following data: -

length of the road = 150 m

Formation width = 10 m

metal width = 8 m

Thickness of grade-I metal = 90 mm
wearing coat of grade-II metal = 12 cm thick loose & 8 cm thick compacted.

1st coat 12 mm chips @ 0.020 m^3 & bitumen @ 1.24 kg per m^2 of road surface.

fuel consumption @ 0.45 kg/kg of bitumen.

2nd coat 8 mm chips @ 0.02 m^3 & bitumen @ 1.24 kg/m^2 of road surface.

Sol:-

Sr. No.	P.O.I.	No.	Length	Breadth	depth	Quantity	Expt. Notes
						150 m^2	
1.	Cleaning of side	1	150	10	-		
2.	Grade-I metal soling	1	150	8	0.09	108 m^3	
3.	Grade-II wearing coat	1	150	8	0.12	144 m^3	
4.	1st coat finishing:						
	12 mm chips @ $0.020 \text{ m}^3/\text{m}^2$	1	150	8	0.020	24 m^3	
	Bitumen @ 1.24 kg/m^2	1	150	8	1.24 kg	1488 kg	
5.	2nd coat finishing:						
	8 mm chips @ $0.02 \text{ m}^3/\text{m}^2$	1	150	8	0.02	24 m^3	
	Bitumen 1.24 kg/m^2	1	150	8	1.24	1488 kg	

Total bitumen = $1488 + 1488 \text{ kg} = 2976 \text{ kg}$

Fuel consumption \rightarrow

For 1 kg bitumen fuel required = 0.45 kg

For 2976 kg bitumen fuel required = 0.45×2976

~~1339.2~~
= 1339.2 kg

Detailed estimate of culvert & bridge

Culvert!— A structure is said to be a culvert when water way or clear span is less than 6m.

Bridge!— A structure is said to be a bridge when the water way or clear span is more than 6m.

Abutment!— The end support of a bridge or culvert is known as "abutment".

Pier!— The intermediate support of a bridge or culvert is known as "pier".

Face wall In a culvert!— The culvert has two face walls in the upstream side & downstream side. → The wall which provides stability to the structure is known as "face wall".

Curtain wall!— The wall in the upstream & the downstream side of a culvert connecting the abutments below ground level in order to prevent scouring of earth below the bed of the culvert.

Q:! What is the min^m dia of concrete pipes provided in a pipe culvert.

Ans!— The dia of the concrete pipe provided in a pipe culvert is restricted to 30cm internal dia.

Wing wall!— It is a smaller wall attached or next to a larger wall or structure. Or the wing walls can either be attached to the abutment or be independent of it. ; Wing walls are provided at both ends of the abutments to retain the earth filling.

Pro-1 Detail estimate of RCC deck slab & vert with right angled wing wall:-

Sl.No	P.O.P	No	Length	Breadth	Depth	Quantity	Expl'n Note
1.	Earth work in excavation Abutment wing wall	2 H	5.1m 1.2	0.7m 0.7m	0.6m 0.6m Total =	4.284 2.016 m ³ 2.016 m ³ 6.3 m ³	$4.8 + 1.5 + 1.5 = 6.1m$
2.	Plain cement concrete in form. Abutment wing wall	2 H	5.1m 1.2m	0.7m 0.7m	0.3m 0.3m Total =	2.142 1.008 3.15 m ³	
3.	Brick work in foundation, plinth & super structure Abutment wing wall Parapet upto kerb Parapet above kerb Parapet coping	2 H 2 2 2	4.8m 1.2m 4.7m 4.7m 4.9m	0.4m 0.4m 0.4m 0.3m 0.4m	1.5m 1.5m 1.5m 0.3m 0.15m 0.1m Total =	5.76 m ³ 2.88 m ³ 2.88 m ³ 2.88 1.128 m ³ 1.41 m ³ 0.392 m ³ 11.57 m ³	$D = 0.3 + 1 + 0.2 = 1.5m$ $L = 4.9 - 0.1 - 0.1 = 4.7m$
	Deduction for bearing of RCC slab	2	4.8m	0.3m	0.2m	0.576 m ³ 1.152 m ³ 11.57 - 0.576 =	11 m ³

4.	RCC work slab	1	4.8m	2.1m	0.2m	2.02m³ 2.02m ³	$B = 1.5 + 1.3 + 1.3 = 2.1m$	
5.	Wearing Coat	1	4m	2.3	0.1	0.92m ³	$B = 1.5 + 0.4 + 0.4 = 2.3m$	
6.	Cement Pointing Face wall below coping upto bottom coping. Inner side of parapet excluding coping. Coping Ends of parapet Ends of coping Deduction for rectangular opening Deduction for triangular portion	2	4.7m	—	2.1m	19.74m ²	$D = 0.1 + 1.5 + 0.5 = 2.1$	
		2	4.7m	0.8m	—	7.62m ²	$B = 0.2 + 0.1 + 0.5 = 0.8$	
		2	4.9m	0.7m	—	0.86m ²	$B = 0.4 + 0.1 + 0.1 + 0.1 = 0.7$	
		4	—	0.4m	0.2m	0.32m ²	$D = 0.1 + 0.1 = 0.2m$	
		4	—	0.3m	0.5m	0.6m ²		
		4	—	0.4m	0.2m	0.32m ²		
						Total =	35.96m ²	
		2	1.5m	—	1-1	3.3m ²		$D = 1 + 0.1 = 1.1m$
		4	$\frac{1}{2} \times 1.3 \times 1.3$	—	Total =	3.38m ²		
			36.36m ²	0.68		Total =	35.68m ²	
						Net pointing =		

Steel bars including bending in RCC work

- 20mm dia straight bar
- 20mm dia bent up bar
- 10mm dia distribution bar at bottom
- 10mm dia distribution bar at top

17	2.38 m	---	---	40.46
16	2.154 m	---	---	40.64
9	4.9 m	---	---	44.1 m
4	4.9 m	---	---	19.6 m
			total -	144.8 m

⇒ Calculation of quantity of steel for deck slab with bar bending schedule: →

→ Unit of Rcc = M^3

→ Main bars are provided along shorter span & distribution bars are provided along longer span.

→ In Rcc work the end or side covers of steel bar may be taken as 4cm to 5cm. & the bottom & top covers may be taken as 1.2cm to 2cm, for Slabs. & 2.5cm to 5cm for beams.

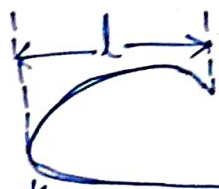

→ The length of one hook may be taken as 9 times of the dia of bar.

→ The total length of a straight bar hooked at both ends may be taken as, " $L + 2 \times 9 \text{ times of dia}$ " which = $L + 18 \text{ dia}$

⇒ For 45° cranked or bent up bar: =

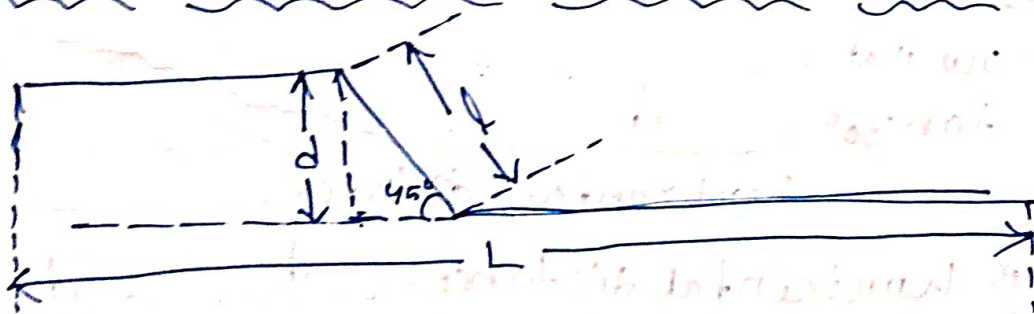

Let, The additional length of one bent up bar = l_1

$$\sin 45^\circ = d/l \quad (\text{P/h})$$

$$\Rightarrow l = \frac{d}{\sin 45^\circ}$$

$$\text{Additional length } (l_1) = l - d = \frac{d}{\sin 45^\circ} - d$$

$$= \frac{d - d \sin 45^\circ}{\sin 45^\circ} = \frac{d(1 - \sin 45^\circ)}{\sin 45^\circ} = \frac{d(1 - 0.707)}{0.707}$$

$$= d \frac{0.292d}{0.0707} = 0.41d \approx 0.45d$$

for two side bent up: additional length = $2 \times 0.45d = 0.9d \approx 1d$

Here, $d =$ total depth of slab - (top cover + bottom cover)

For 30° cranked or bent up bar,

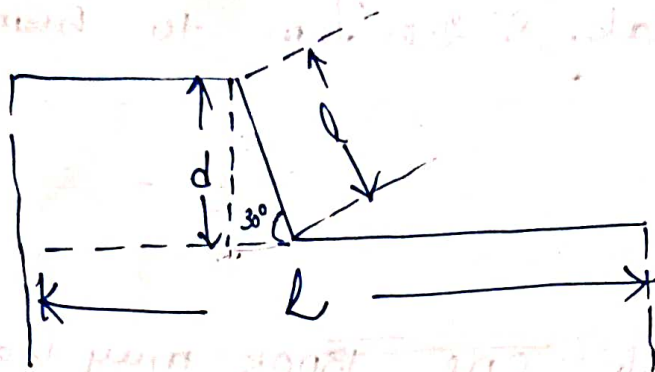

$$\sin 30^\circ = \frac{d}{l}$$

$$\Rightarrow l = \frac{d}{\sin 30^\circ}$$

Additional length = $l -$ horizontal distance

we know that,

$$\tan 30^\circ = \frac{d}{\text{horizontal distance}}$$

$$\Rightarrow \text{horizontal distance} = \frac{d}{\tan 30^\circ} = \frac{d}{0.57}$$

$$\text{Additional length } l_1 = \frac{d}{0.5} - \frac{d}{0.57}$$

$$= 0.57d - 0.5d$$

$$= \frac{0.07d}{0.285} = \frac{0.07}{0.285} d \approx 0.24d$$

for 2 side bent up additional length = $2 \times 0.25d$
 $= 0.5d$

$D \times L = 1.2 \times 1.6$

Prq-1

Prepare a detailed Estimate of RCC slabs culvert

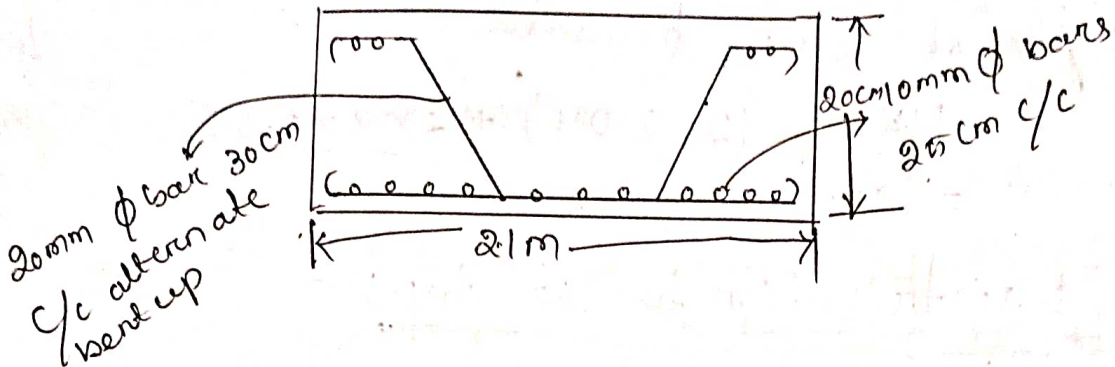

Solⁿ

20 mm phi straight bar :-

No of bar = $\frac{4.8 - 2 \times 0.04}{0.3} + 1$

Length of 20mm bar \rightarrow

$2.1 - 2 \times 0.04 + (18 \times 0.2)$

$\Rightarrow 2.38m$

20 mm dia bent up bar :-

No of bar = $17 - 1 = 16$ nos

Length of 20mm bar \rightarrow

$2.1 - 2 \times 0.04 + (2 \times 9 \times 0.02) + d$

$2.38 + 0.2 - (2 \times 0.02)$

$= 2.54m$

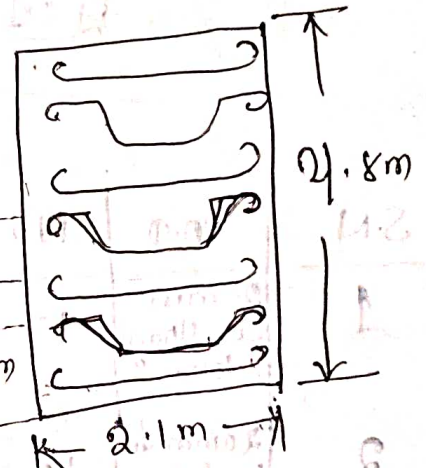

10 mm ϕ distribution bar at bottom :-

$$\text{No of bar} = \frac{2.1 - (2 \times 0.04)}{0.25} + 1$$

$$= 9.08 \approx 9 \text{ nos}$$

Length of 10mm ϕ bars =

$$4.8 - (2 \times 0.04) + (2 \times 9 \times 0.01)$$

$$= 4.9 \text{ m.}$$

10mm ϕ distribution bar at top :-

No of bar -

$$\rightarrow \frac{2.1}{4} = 0.525 - 0.04 + 1 = 2.3 \approx 2 \text{ nos}$$

0.25

DT-8.2.16

S.N	PO. T	NO	L	B	D	Q	Exptl note
1	20mm dia straight bar	17	2.38m	-	-	40.46 m	
2	20mm dia bent up bar	16	2.54m	-	-	40.64 m	

total = 81.1m

Area of 20mm dia bar = $\frac{\pi}{4} \times (20)^2$

$$= 0.000314 \text{ m}^2$$

quantity or volume of 20mm dia bar =

Area \times Length

$$= 0.000314 \times 81.1$$

$$= 0.025 \text{ m}^3$$

1 m³ steel wt = 7850 kg

$$0.025 \text{ m}^3 \text{ steel wt} = 7850 \times 0.025 = 196.25 \text{ kg}$$

S.N	P.O.P	NO	L	B	D	Q	Expn Note
3	10mm dia distribu- -tion bar at bottom	9	4.9			44.1m	
4	10mm dia distribu- -tion bar at top	24	4.9			19.6m	
Total = 63.7m							

Area of 10mm dia bar = $\pi/4 \times (0.01)^2$
 $= 0.0000785 \text{ m}^2$

quantity or volume of 10mm dia bar
 $= \text{Area} \times \text{length}$
 $= 0.005 \text{ m}^3$

1m³ steel wt = 7850 kg

0.005m³ steel wt = 39.27 kg

Total wt = 39.27 + 196.25

= 235.52 kg

quantity of steel including 10% wastage =

10% wastage = $235.52 \times \frac{10}{100}$
 $= 23.55$

Total quantity of steel including 10% wastage.

$235.52 + 23.55$

= 259.072 kg

quantity of binding wire =

Area of slab = $L \times B = 4.8 \times 2.1 = 10.08 \text{ m}^2$

for 10m² slab binding wire required = 2.7 kg

for 1m² slab binding wire required = $\frac{2.7}{10}$

= 0.27 kg

for 10.08m² slab " " = 0.27×10.08
 $= 2.72 \text{ kg}$

Quantity of steel per m³ of concrete :-

$$\text{Volume of slab} = L \times B \times d = 4.8 \times 2.1 \times 0.2 = 2.016 \text{ m}^3$$

For 2.016 m³ RCC work steel required = 259.072 kg

$$\text{For 1 m}^3 \text{ RCC work steel required} = \frac{259.072}{2.016} = 128.89 \text{ kg}$$

Pro-2

Estimate, (a) the quantity of steel including 10% wastage.

(b) quantity of binding wire

(c) quantity of steel per m³ of concrete

Data given :-

A RCC Slab of 3.5 m clear span & 5 m long & thickness of slab = 12 cm.

Main bar = 10 mm dia bar 30 cm C-C with alternate bent up.

Distribution bar = 6 mm dia bar 20 cm C-C

Assume any other data.

Solⁿ

Let,

Thickness of wall = 30 cm

~~Effective span = 3.5~~

$$L = 5 + \frac{3}{2} + \frac{3}{2} = 5.3 \text{ m}$$

$$B = 3.5 + \frac{3}{2} + \frac{3}{2} = 3.8 \text{ m}$$

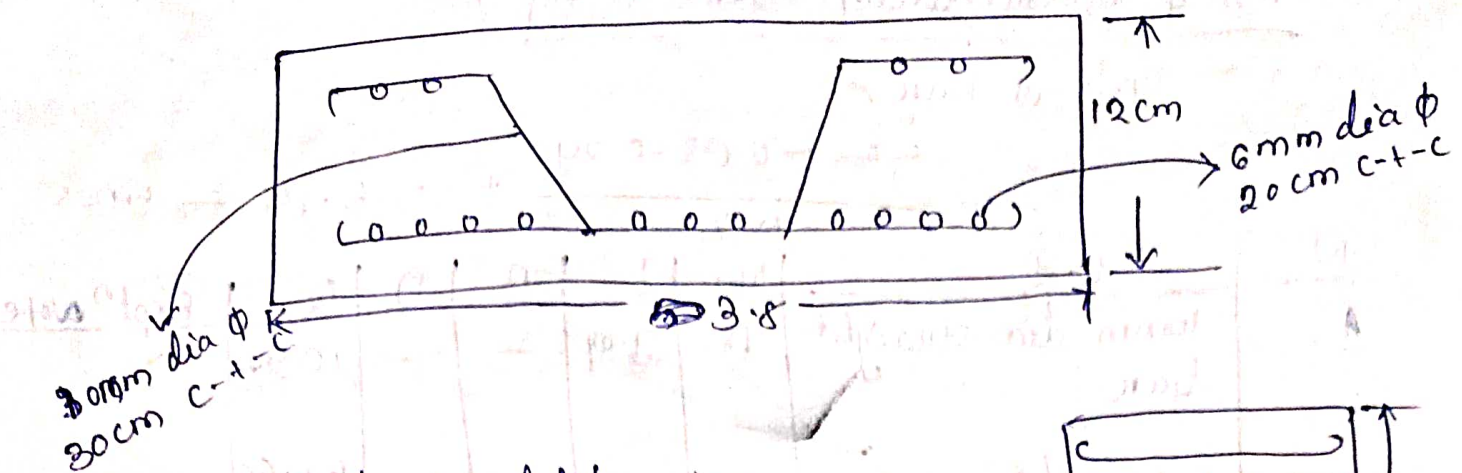

Cal?

10mm ϕ Straight bar :-

$$\text{No. of bar} = \frac{5.3 - 2 \times 0.04}{0.3} + 1$$

$$= 18.4 \approx 18 \text{ nos}$$

Length of 10mm bar :- \rightarrow

$$3.8 - 2 \times 0.04 + (18 \times 0.02)$$

$$= 3.98 \text{ m}$$

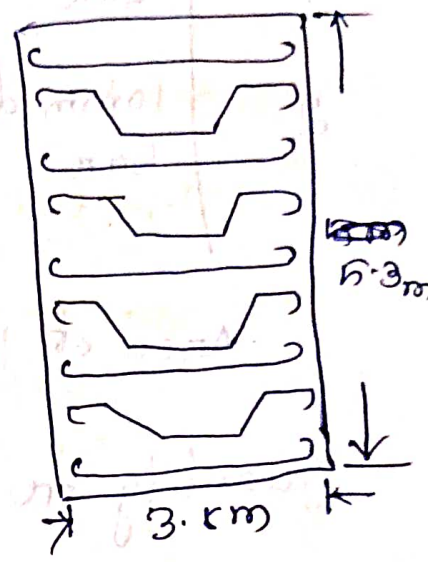

20mm ϕ dia bent up bar :-

$$\text{No of bar} = 18 - 1 = 17 \text{ nos}$$

Length of 20mm bar :- \rightarrow

$$3.8 - 2 \times 0.04 + (2 \times 9 \times 0.02) + d$$

$$= 3.9 + (0.12 - (2 \times 0.02))$$

$$= 3.98 \text{ m}$$

6mm distribution bar at bottom :-

$$\text{No of bar} = \frac{3.8 - (2 \times 0.04) + 1}{0.20}$$

$$= 19.6 \approx 19 \text{ nos}$$

Length of 6mm ϕ bars.

$$5.3 - (2 \times 0.04) + (2 \times 9 \times 0.006)$$

$$= 5.32 \text{ m}$$

6mm dia distribution bar at top :=

No of bar :=

$$\frac{3.8}{4} = 0.95 \approx 1 \text{ nos}$$

S.N	P.O.D	NO	L	B	D	Q	Expl ⁿ Note
1	10mm dia straight bar	18	3.04	-	-	78.90 m	
2	10mm dia bent up bar	19	3.98	-	-	67.66 m	

Total = ~~147.56~~
137.56

Area of 10 mm dia bar = $\frac{\pi}{4} \times (0.01)^2$
= 0.0000785 mm²

quantity or volume of 10mm dia bar,
Area x length
= 0.0000785 x ~~147.56~~ 137.56
= 0.010 m³

1 m³ Steel wt = 7850 kg

0.01 m³ steel wt = 7850 x 0.01 = ~~78.5~~ 78.5 kg

S.N	P.O.D	NO	L	B	D	Q	Expl ⁿ Note
3.	6mm dia distribution bar at bottom	19	5.32	-	-	101.08	
4.	6mm dia distribution bar at top	10	5.32	-	-	53.2	

Total = 154.28 m

Area of 6 mm dia bar = $\frac{\pi}{4} \times (0.006)^2$
= 0.0000282 mm²

quantity or volume of $\phi 6$ mm dia bar = Area \times length
 $= 0.0000282 \times 154.28$
 $= 0.0043 \text{ m}^3$

1 m³ steel wt = ~~7850~~ = 7850 kg

0.0043 m³ steel wt = 0.0043×7850

= 33.75 kg

Total wt = ~~78.5~~ + 33.75

= 112.25 kg

quantity of steel including 10% wastage =

10% wastage = $112.25 \times \frac{10}{100}$

Total quantity of Steel = 112.25

= 112.25 + 11.225

= 123.5 kg

quantity of binding wire =

Area of slab = L \times B = $5.3 \times 3.8 = 20.14 \text{ m}^2$

for 10 m² slab binding wire required = 2.7 kg

for 1 m² " " " " = $\frac{2.7}{10} = 0.27 \text{ kg}$

for 20.14 m² slab binding wire required = 0.27×20.14
 $= 5.43 \text{ kg}$

quantity of steel per m³ of concrete =

Volume of slab = L \times B \times d = $5.3 \times 3.8 \times 0.12$
 $= 2.41 \text{ m}^3$

for 2.41 m³ rcc work steel required = $\frac{123.5}{2.41}$

for 1 m³ rcc work steel required = $\frac{123.5}{2.41}$

$\frac{V \cdot V \cdot G}{100} = \frac{123.5}{2.41} = 51.24 \text{ Kg (Ans)}$

Ch-4

PHWD ACCOUNTS WORK:-

Work:-

For any original work, the engg. department prepares a proposal on the basis of preliminary estimate from the requirements and information supplied by the department concerned concerned.

Classification of work:-

Classification of work according to their nature:-

The works according to their nature are classified into following 2 types.

(a) Original work

(b) Repair work

(A) Original Work:-

The original work may be of following types.

→ Entirely new construction as construction of new building, bridge, road or any project etc.

* Addition & alteration to the existing works which will increase the value of property.

Ex:- Addition of room or rooms, Conversion of a ~~barandah~~ barandah into rooms, dividing a big room into 2 rooms etc.

* Special work for renovation or for thorough repairs of damaged works.

Ex:- Changing of door or window, changing of floor.

(b) Repair Work :-

Repair work may be of following types.

→ The repairs required to maintain the work in proper condition as annual repairs.

Ex :- white washing, colour washing etc.

→ Minor addition & alteration with in certain Monetary limit. (say Rs 200).

Ex :- Providing sunsets, opening a door, providing shelves.

→ special repair.

Classification of work according to their cost :-

According to their cost works are classified in to following 3 types.

- (a) Major work
- (b) Minor work
- (c) Petty work

(a) Major work :-

The work costing more than a lakhs is known as major work. And the estimate for such work is known as major estimate.

(b) Minor work :-

The work costing more than Rs. 50,000 but but not exceeding 2 lakhs is known as minor work.

And the estimate for such work is known as minor work estimate.

(c) Petty work :-
The work which cost doesn't exceed Rs 50,000 is known as petty work.

And the estimate for such work is known as petty estimate.

Different types of repair work :-

There are 3 types of repair work

- (i) Annual repair
- (ii) Quadrennial repair
- (iii) special repair

(i) Annual repair :-

All works & structure are repaired & maintained in a proper condition!

→ The repair which is done annually i.e. once in a year is known as annual repair.

→ The annual repairs work are executed by the department concerned as medical department buildings are maintained by the medical department & police department buildings are maintained by police department

ex :- white washing, colour washing etc.

(b) Quadrennial repair :-

Besides annual repair of work such as white washing, colour washing the repair works are done.

→ The repair which is done every 4th year is known as quadrennial repair work.

ex:-

Repainting of door & window, patch repair of plastering etc.

(c) Special Repair :- Special repair work consist of renovation or renewals of structures or of damaged works.

ex:- Renewal of floor & other items of works involving replacement occurring at long intervals.

Repair of monsoon or flood damage work

Date:- 25-02-2016

Earnest Money deposit :-

→ While submitting a tender the contractor is to deposit a certain amount, about 2% of the estimated cost with the department as earnest money as guarantee of the tender.

→ This amount is for a check so that the contractor may not refuse to accept the work or run away when his tender is accepted.

→ In case of the contractor refuses to take up the work his earnest money is forfeited.

→ Earnest money of the tender whose tender has not been accepted is refundable.

Security Money deposited :-
→ On acceptance of the tender, the contractor has to deposit 10% of the tendered amount as security money with the department which is inclusive with the earnest money already deposited.
→ This amount is kept as a check so that the contractor fulfills all the terms & condition of the contract & carries out the work satisfactorily. According to the specification and complete the work in time.

→ If the contractor fails to fulfill the term of contract his part of the security money is forfeited by the department.

→ The security money is refundable to the contractor after the satisfactory completion of the whole work after a specified time.

Contractor :-

A person who contracts and undertakes any type of contract is known as contractor.

Contract :-

An undertaking by a person to do any work under some terms & conditions is known as contract.

→ The work may be supplied of labour, supply of Material, construction or maintenance & repairs etc.

Tender :-

Tender is an offer in writing to execute some specified work at certain rates with in a fixed time under certain conditions of contract & agreement betⁿ a contractor & department.

Types of Contract :-

There are 4 types of Contract :-

(a) Lumpsum contract

(b) Labour contract

(c) Item rate contract

(d) Cost plus percentage contract.

dt :- 26.02.2016

(a) Lumpsum contract :-

→ In lumpsum contract the contractor undertakes the execution or construction of a specific work with all its contingencies to complete it in all respect with in a specified time for a fixed amount.

→ The detail specification of all items of works pertaining to the whole work, plans & drawing & deposit of 10% security money, progress & other condition of contracts included in the contract agreement.

→ The general specification of different parts of the building with the dimensions where required are included.

The quantities of different items of work are not provided; the contractor shall have to complete the work as per plan & specification with in fixed rate fixed time.

→ On completion of the work no detail measurement of different items of work is required but the whole work is compared & checked with plans & drawings.

(b) Labour contract :-

In this type of contract the contractor undertakes the contract for the labour only. All materials for the construction are arranged & supplied at the site of work by the department.

→ The labour contract engages labour & gets the work done according to the specification.

→ The contract is on item rate basis for labour person only & contractor is to pay the quantities of work done at a set stipulated rate.

→ Materials for scaffolding, centring and shuttering & other similar materials are supplied by the department.

→ Contractor use his own tools for working, but plans & machineries are arranged by the department or owner.

(c) Item rate Contract :-

In this contract the contractor undertakes the construction of work on the item rate basis.

→ The amount, the contractor is to receive depends upon the quantities of various items of work actually done.

→ The contract agreement includes quantities, rates & amount for various items of work, date of completion & other condition of contract.

→ The payment to the contractor is made by after-tail measurement of different items of work actually done by the contractor.

This system is used for all work.

(a) Cost plus percentage contract :=

→ In this type of contract, the contractor is given some percentage over the actual cost of construction as his profit.

→ Contractor arrange materials & labour at his cost & keeps proper account & is paid by the department, the whole cost together with certain percentage

say 10% as his profit.

→ An agreement is prepared with all conditions of contract in advance.

→ In this case proper control in the purchase of materials & in labour shall have to be exercised by the department.

Advance payment :=

→ This means the payment made on a running account to a contractor, for work done by him is not measured.

→ Advance payment is not generally made to the contractor but may be made under some special cases when

The work is sufficiently progressed.

On-account payment or running payment: =

This means the payment made on a running account to a contractor for work done or supplies made by him duly measured & entered in M.B.

→ When only a part of the whole work or supplies has been done & the work is in progress, during the progress of the work contractor is paid time to time.

Intermediate payment: =

Any payment on running account in betⁿ 1st & last payment to a contractor is known as intermediate payment.

Final payment: =

This term indicates a single payment, made for a job or contract on its completion. In this case the payment is finished by one payment after completion of the work. This is usually applicable for small work.

Bill: =

→ Bill is the account of work done or supply of materials made & includes the particulars or quantities of work done or material supplied, their rates & amount due.

Final bill: →

The bill on which final payment is made is known as final bill.

Running or on account bill: →

The bill on which the running or on account payment is made is known as running bill or on account bill.

Regular establishment: =

→ Both permanent & temporary employees of the department are included in the regular establishment.

- Their salaries are drawn monthly on regular pay bills from the treasury.
- The payment to each is made after taking receipt (stamped signature) on the pay bill.
- The salary is not from the budget grant under the head establishment.

Temporary Establishment:

- The temporary establishment are employed when the work is increased & extra load cannot carry by the existing permanent employees.
- Their services can be terminated at any time with proper notice as per as rules.
- These posts are sanctioned usually for six or twelve months.

Cash:

- cash includes all legal tender coins, currency notes, demand drafts, cheques, payable on demand, revenue stamps etc recognised by reserve bank of india.
- postal stamps, national saving certificates government securities bonds etc are not treated as cash.

TEMPORARY ADVANCE:

- Temporary advance is also known as temporary imprest.
- Temporary imprest is the amount which is advanced by a disbursing officer to a subordinate officer to enable him to make a number of specific payments out of a muster roll or any other voucher which has already been passed for payment.
- The amount of temporary advance should be closed as soon as possible.
- The temporary advance amount is advance for payment of passed bills, while the permanent.

The Imprest amount is advanced for payment of unpassed bills as & when required.

ISSUE RATE:

⇒ An issue rate is fixed for each article of stock on the basis of actual cost plus other expenses including storage charges.

⇒ The issue rate is fixed on the principle that there may not be ultimate profit or loss in the stock account. The rate should include the actual cost.