

BUILDING MATERIALS
&
CONSTRUCTION TECHNOLOGY

TH-3

3rd SEM
CIVIL ENGG.

Under SCTE&VT, Odisha

PREPARED BY:-



Er. RAJASHREE SAHOO

LECTURER, Dept of CIVIL, KALINGA NAGAR POLYTECHNIC.

TARAPUR, JAJPUR ROAD

SYLLABUS

Module Number	Chapter Number	Title	Lecture hours (3-1-0)
1	1	Brick	3
	2	Cement	4
	3	Concrete	3
Total			10
2	4	Arches	3
	5	Cavity Wall	2
	6	Stairs	3
Total			8
3	7	Fire Resistive Construction	2
	8	Plastering	2
	9	Damp prevention	2
Total			6
4	10	Types of doors and windows	3
	11	Painting and decoration	2
	12	Glazing	2
	13	Repair of Building	2
	14	Stone	1
	15	Timber	4
	16	Foundation	2
Total			16
Total lecture hours			40

Text books

1. A Text book of Building Construction, S.P. Arora and S.P. Bindra, Dhanpat Rai & Sons.

Reference books

- 1 A Text Book of Building Materials, C.J. Kulkarni
- 2 Building Materials, P. C. Varghese, PHI, Pvt. Ltd.
- 3 Building Construction, P. C. Varghese, PHI, Pvt. Ltd.

1. BRICK

Constituents of good brick earth:

Bricks are the most commonly used construction material. Bricks are prepared by moulding clay in rectangular blocks of uniform size and then drying and burning these blocks. In order to get a good quality brick, the brick earth should contain the following constituents.

- Silica
- Alumina
- Lime
- Iron oxide
- Magnesia

Silica

- Brick earth should contain about 50 to % of silica.
- It is responsible for preventing cracking, shrinking and warping of raw bricks.
- It also affects the durability of bricks.
- If present in excess, then it destroys the cohesion between particles and the brick becomes brittle.

Alumina

- Good brick earth should contain about 20% to 30% of alumina.
- It is responsible for plasticity characteristic of earth, which is important in moulding operation.
- If present in excess, then the raw brick shrink and warp during drying.

Lime

- The percentage of lime should be in the range of 5% to 10% in a good brick earth.
- It prevents shrinkage of bricks on drying.
- It causes silica in clay to melt on burning and thus helps to bind it.
- Excess of lime causes the brick to melt and brick loses its shape.

Iron oxide

- A good brick earth should contain about 5% to 7% of iron oxide.
- It gives red colour to the bricks.
- It improves impermeability and durability.
- It gives strength and hardness.
- If present in excess, then the colour of brick becomes dark blue or bluish.
- If the quantity of iron oxide is comparatively less, the brick becomes yellowish in colour.

Magnesia

- Good brick earth should contain less a small quantity of magnesia about 1%)
- Magnesium in brick earth imparts yellow tint to the brick.
- It is responsible for reducing shrinkage
- Excess of magnesia leads to the decay of bricks.

Harmful Ingredients in Brick:

Below mentioned are some of the ingredients which are undesired in brick earth.

Lime

- A small quantity of lime is required in brick earth. But if present in excess, it causes the brick to melt and hence brick loses its shape.
- If lime is present in the form of lumps, then it is converted into quick lime after burning. This quick lime slakes and expands in presence of moisture, causing splitting of bricks into pieces.

Iron pyrites

- The presence of iron pyrites in brick earth causes the brick to get crystallized and disintegrated during burning, because of the oxidation of the iron pyrites.
- Pyrites discolourise the bricks.

Alkalis

- These exist in the brick earth in the form of soda and potash. It acts as a flux in the kiln during burning and it causes bricks to fuse, twist and warp. Because of this, bricks are melted and they lose their shape.
- The alkalis remaining in bricks will absorb moisture from the atmosphere, when bricks are used in masonry. With the passage of time, the moisture gets evaporated leaving grey or white deposits on the wall surface (known as **efflorescence**). This white patch affects the appearance of the building structure.

Pebbles

- Pebbles in brick earth create problem during mixing operation of earth. It prevents uniform and thorough mixing of clay, which results in weak and porous bricks
- Bricks containing pebbles will not break into shapes as per requirements.

Vegetation and Organic Matter

- The presence of vegetation and organic matter in brick earth assists in burning. But if such matter is not completely burnt, the bricks become porous. This is due to the fact that the gases will be evolved during the burning of the carbonaceous matter and it will result in the formation of small pores.

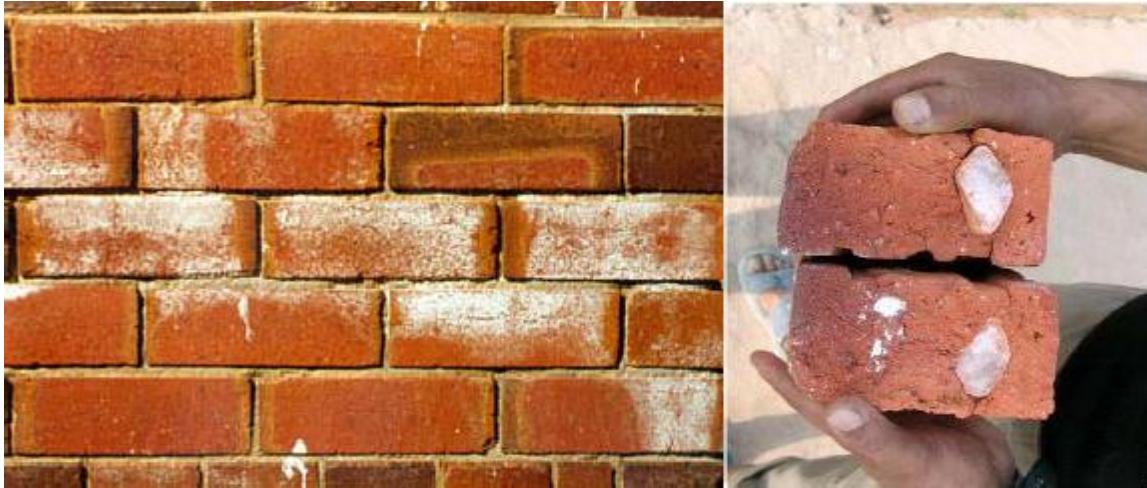

Efflorescence in BrickStone in Brick

Manufacturing of bricks

In the process of manufacturing bricks, the following distinct operations are involved.

- Preparation of clay
- Moulding
- Drying
- Burning

Each of the above operation of the manufacturing bricks will now be studied at length.

Preparation of clay

The clay for brick is prepared in the following order.

- Unsoiling
- Digging
- Cleaning
- Weathering
- Blending
- Tempering

Unsoiling: The top layer of the soil, about 200mm in depth, is taken out and thrown away. The clay in top soil is full of impurities and hence it is to be rejected for the purpose of preparing bricks.

Digging: The clay is then dug out from the ground. It is spread on the levelled ground, just a little deeper than the general level. The height of heaps of clay is about 600mm to 1200mm.

Cleaning: The clay as obtained in the process of digging should be cleaned of stones, pebbles, vegetable matters. If these particles are in excess, the clay is to be washed and screened. Such a process naturally will prove to be troublesome and expensive.

Weathering: The clay is then exposed to atmosphere for softening and mellowing. The period varies from few weeks to full season.

Blending: The clay is made loose and any ingredient to be added to it, is spread out at its top. The blending indicates intimate or harmonious mixing. It is carried out by taking a small amount of clay every time and turning it up and down in vertical direction. The blending makes clay fit for the next stage of tempering.

Tempering: In the process of tempering, the clay is brought to a proper degree of hardness and it is made fit for the next operation of moulding. Kneaded or pressed under the feet of man or cattle. The tempering should be done exhaustively to obtain homogeneous mass of clay of uniform character. For manufacturing good bricks on a large scale, tempering is done in pug mill. A typical pug mill capable of tempering sufficient earth for a daily output of about 15000 to 20000 bricks.

A pug mill consists of a conical iron tub with cover at its top. It is fixed on a timber base which is made by fixing two wooden planks at right angle to each other. The bottom of tub is covered except for the hole to take out pugged earth. The diameter of pug mill at bottom is about 800mm and that at top is about 1 m. The provision is made in top cover to place clay inside pug mill. A vertical shaft with horizontal arms is provided at center of iron tub. The small wedge-shaped knives of steel are fixed at arms. The long arms are fixed at vertical shaft to attach a pair of bullocks. The ramp is provided to collect the pugged clay. The height of pug mill is about 2m. Its depth below ground is 600mm to 800mm less than the rise of the barrow run and to throw out the tempered clay conveniently. In the beginning, the hole for pugged clay is closed and clay with water is placed in pug mill from the top. When vertical shaft is rotated by a pair of bullock, the clay is thoroughly mixed up by the action of horizontal arms and knives and homogeneous mass is formed.

The rotation of vertical shaft can also be achieved by using steam, diesel or electrical power. When clay has been sufficiently pugged, the hole at the bottom of the tub, is opened out and pugged earth is taken out from the ramp by barrow i.e. a small cart with wheels for next operation of moulding. The pug mill is then kept moving and feeding of clay from top and taking out of pugged clay from bottom are done simultaneously. If tempering is properly carried out, the good brick earth can then be rolled without breaking in small threads of 3mm diameter.

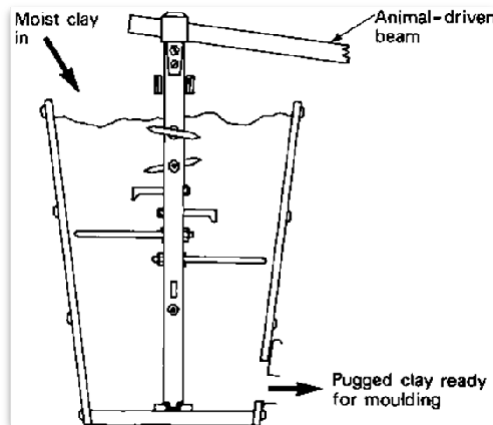

Fig of a Pug mill

Moulding:

The clay which is prepared as above is then sent for the text operation of moulding. Following are two types of moulding:

- i. Hand Moulding
- ii. Machine Moulding

Hand moulding:

In hand moulding , the bricks are moulded by hand *i.e.*; manually. It is adopted where manpower is cheap and is readily available for the manufacturing process of bricks on a small scale. The moulds are rectangular boxes which are open at top and bottom. They may be of wood or steel. It should be prepared from well-seasoned wood. The longer sides are kept slightly projecting to serve as handles. The strips of brass or steel are sometimes fixed on the edges of wooden moulds to make them more durable. It is prepared from the combination of steel plate and channel. It may even be prepared from steel angles and plates. The thickness of steel mould is 6mm. They are used for manufacturing bricks on a large scale. The steel moulds are more durable than wooden one and turn out bricks of uniform size. The bricks shrink during drying and burning . Hence the moulds are therefore made larger than burnt bricks (8-12%).

The bricks prepared by hand moulding are of two types: Ground moulded and Table moulded

Ground moulded bricks: The ground is first made level and fine sand is sprinkled over it. The mould is dipped in water and placed over the ground. The lump of tempered clay is taken and is dashed in the mould. The clay is pressed in the mould in such a way that it fills all the corners of mould. The surplus clay is removed by wooden strike or framed with wire. A strike is a piece of wood or metal with a sharp edge. It is to be dipped in water every time. The mould is then lifted up and raw brick is left on the ground. The mould is dipped in water and it is placed just near the previous brick to prepare another brick. The process is repeated till the ground is covered with raw bricks. The lower faces of ground moulded bricks are rough

and it is not possible to place frog on such bricks. A frog is mark of depth about 10mm to 20mm which is placed on raw brick during moulding. It serves two purposes.

1. It indicates the trade name of the manufacturer

2. In brick work, the bricks are laid with frog uppermost. It thus affords a key for mortar when the next brick is placed over it.

The ground moulded bricks of better quality and with frogs on their surface are made by using a pair of pallet boards and a wooden block. A pallet is a piece of thin wood. The block is bigger than the mould and it has projection of about 6mm height on its surface. The dimensions of projection correspond to internal dimensions of mould. The design of impression or frog is made on this block. The wooden block is also known as the moulding block or stock board.

The mould is placed to fit in the projection of wooden block and clay is then dashed inside the mould. A pallet is placed on the top and the whole thing is then turn upside down. The mould is taken out and placed over the raw brick and it is conveyed to the drying sheds. The bricks are placed to stand on their longer sides in drying sheds and pallet boards are brought back for using them again. As the bricks are laid on edge, they occupy less space and they dry quicker and better.

Table Moulded Bricks:

- i) The process of moulding of bricks is just similar as above. But in this case, the mould stands near a table size 2m x 1m. The bricks are moulded on the table and send for further process of drying.
- ii) However the efficiency of the moulder gradually decreases because of standing at some place for a longer duration. The cost of brick is also increases when table moulding is adopted.

Machine Moulding:

This type of moulding is carried out by two processes:

- i) Plastic clay machine
- ii) Dry clay machine

Plastic Clay Moulding

i) Such machine consists of a rectangular opening having length and width is equal to an ordinary bricks. The pugged clay is placed in the machine and it comes out through the rectangular opening.

ii) These are cut into strips by the wire fixed at the frame. The arrangement is made in such a way that the strips thickness is equal to that of the bricks are obtained. So it is also called as WIRE CUT BRICKS.

Dry Clay Machinemoulding:

In these machines, the strong clay is finally converted in to powered form. A small quantity of water is then added to form a stiff plastic paste.

ii) Such paste is placed in mould and pressed by machine to form dry and well-shaped bricks. They do not require the process of drying.

Drying

The damp bricks, if brunt, are likely to be cracked and distorted. Hence the moulded bricks are dried before they are taken for the next operation of burning. For the drying the bricks are laid longitudinally in the stacks of width equal to two bricks. A stack consists of ten or eight tiers. The bricks are laid along and across the stock in alternate layers. All the bricks are placed on edges. The bricks are allowed to dry until the bricks are become leather hard of moisture content about 2%.

Burning

Bricks are burned at high temperature to gain the strength, durability, density and red color appearance. All the water is removed at the temperature of 650 degrees but they are burnt at an temperature of about 1100 degrees because the fusing of sand and lime takes place at this temperature and chemical bonding takes between these materials after the temperature is cooled down resulting in the hard and dense mass.

Bricks are not burnt above this temperature because it will result in the melting of the bricks and will result in a distorted shape and a very hard mass when cooled which will not be workable while brickwork. Bricks can be burnt using the following methods:

- (a) Clamp Burning
- (b) Kiln Burning

Clamp Burning:

Clamp is a temporary structure generally constructed over the ground with a height of about 4 to 6 m. It is employed when the demand of the bricks is lower scale and when it is not a monsoon season. This is generally trapezoidal in plan whose shorter edge among the parallel sides is below the ground and then the surface raising constantly at about 15 degrees to reach the other parallel edge over the ground. A vertical brick and mud wall is constructed at the lower edge to support the stack of the brick. First layer of fuel is laid as the bottom most layer with the coal, wood and other locally available material like cow dung and husk. Another layer of about 4 to 5 rows of bricks is laid and then again a fuel layer is laid over it. The thickness of the fuel layer goes on with the height of the clamp.

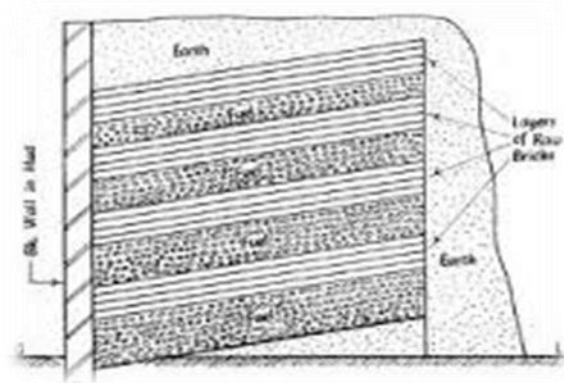

After these alternate layers of the bricks and fuel the top surface is covered with the mud so as to preserve the heat. Fire is ignited at the bottom, once fire is started it is kept under fire by itself for one or two months and same time period is needed for the cooling of the bricks.

Disadvantages of Clamp burning:

1. Bricks at the bottom are over-burnt while at the top are under-burnt.
2. Bricks loose their shape, and reason may be their descending downward once the fuel layer is burnt.
3. This method cannot employ for the manufacturing of large number of bricks and it is costly in terms of fuel because large amount of heat is wasted.
4. It cannot be employed in monsoon season.

Kiln Burning:

Kiln is a large oven used for the burning of bricks. Generally coal and other locally available materials like wood, cow dung etc can be used as fuel. They are of two types:

- Intermittent Kilns.
- Continuous Kilns.

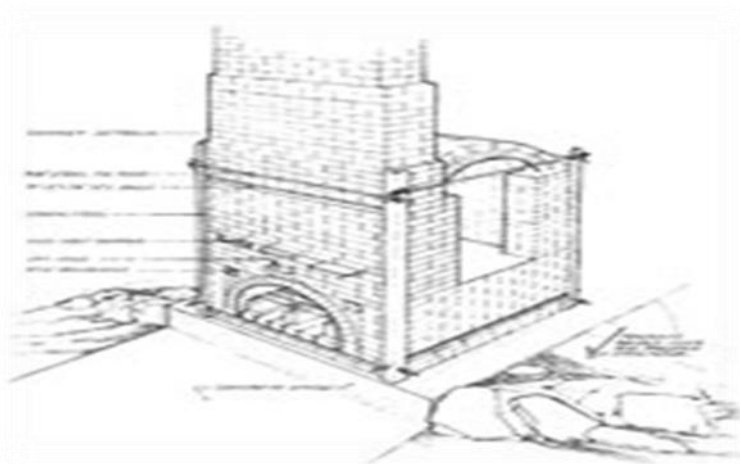

Fig of a typical kiln

Intermittent Kilns: these are also the periodic kind of kilns, because in such kilns only one process can take place at one time. Various major processes which takes place in the kilns are:*Loading, unloading, Cooling, and Burning of bricks.*

There are two kind of intermittent kilns:

- (i) Up-draught Intermittent Kilns
- (ii) Down draught Intermittent Kilns

Down draught kilns are more efficient because the heat is utilized more by moving the hot gases in the larger area of the kiln. In up draught kilns the hot gases are released after they rise up to chimney entrance.

Continuous Kilns:

These kilns are called continuous because all the processes of loading, unloading, cooling, heating, pre-heating take place simultaneously. They are used when the bricks are demanded in larger scale and in short time. Bricks burning are completed in one day, so it is a fast method of burning. There are two well-known continuous kilns:

Bull's Trench Kiln: Bull's trench kiln consists of a rectangular, circular or oval plan shape. They are constructed below the ground level by excavating a trench of the required width for the given capacity of brick manufacturing. This Trench is divided generally in 12 chambers so that 2 numbers of cycles of brick burning can take place at the same time for the larger production of the bricks. Or it may happen that one cycle is carried out at one time in all the 12 chambers by using a single process in the 2-3 chambers at the same time. The structure is under-ground so the heat is conserved to a large extent so it is more efficient. Once fire is started it constantly travels from one chamber to the other chamber, while other operations like loading, unloading, cooling, burning and preheating taking place simultaneously.

Such kilns are generally constructed to have a manufacturing capacity of about 20,000 bricks per day. The drawback of this kiln is that there is not a permanent roof, so it is not easy to manufacture the bricks in the monsoon seasons.

Hoffman's Kiln: The main difference between the Bull's trench kiln and the Hoffman kilns are:

1. Hoffman's kiln is an over the ground structure while Bull's Trench Kiln is an underground structure.
2. Hoffman's kiln have a permanent roof while Bull's trench Kiln do not have so it former can be used in 12 months a year to manufacture bricks but later is stopped in the monsoon season.

Hoffman's kiln is generally circular in plan, and is constructed over the ground. The whole structure is divided into the 12 chambers and the entire processes takes place simultaneously like in Bull's trench Kiln.

Classification of Bricks as per common practice:

Bricks, which are used in construction works, are burnt bricks. They are classified into four categories on the basis of its manufacturing and preparation, as given below.

1. First class bricks
2. Second class bricks
3. Third class bricks
4. Fourth class bricks

First Class Bricks:

These bricks are table moulded and of standard shape and they are burnt in kilns. The surface and edges of the bricks are sharp, square, smooth and straight. They comply with all the qualities of good bricks. These bricks are used for superior work of permanent nature.

Second Class Bricks:

These bricks are ground moulded and they are burnt in kilns. The surface of these bricks is somewhat rough and shape is also slightly irregular. These bricks may have hair cracks and their edges may not be sharp and uniform. These bricks are commonly used at places where brick work is to be provided with a coat of plaster.

Third Class Bricks:

These bricks are ground moulded and they are burnt in clamps. These bricks are not hard and they have rough surfaces with irregular and distorted edges. These bricks give dull sound when struck together. They are used for unimportant and temporary structures and at places where rainfall is not heavy.

Fourth Class Bricks:

These are over burnt bricks with irregular shape and dark colour. These bricks are used as aggregate for concrete in foundations, floors, roads etc, because of the fact that the over burnt bricks have a compact structure and hence they are sometimes found to be stronger than even the first class bricks.

Classification of Bricks as per constituent materials

There are various types of bricks used in masonry.

- Common Burnt Clay Bricks
- Sand Lime Bricks (Calcium Silicate Bricks)
- Engineering Bricks
- Concrete Bricks
- Fly ash Clay Bricks

Common Burnt Clay Bricks

Common burnt clay bricks are formed by pressing in moulds. Then these bricks are dried and fired in a kiln. Common burnt clay bricks are used in general work with no special attractive appearances. When these bricks are used in walls, they require plastering or rendering.

Sand Lime Bricks

Sand lime bricks are made by mixing sand, fly ash and lime followed by a chemical process during wet mixing. The mix is then moulded under pressure forming the brick. These bricks can offer advantages over clay bricks such as: their colour appearance is grey instead of the regular reddish colour. Their shape is uniform and presents a smoother finish that doesn't require plastering. These bricks offer excellent strength as a load-bearing member.

Engineering Bricks

Engineering bricks are bricks manufactured at extremely high temperatures, forming a dense and strong brick, allowing the brick to limit strength and water absorption. Engineering bricks offer excellent load bearing capacity damp-proof characteristics and chemical resisting properties.

Concrete Bricks

Concrete bricks are made from solid concrete. Concrete bricks are usually placed in facades, fences, and provide an excellent aesthetic presence. These bricks can be manufactured to provide different colours as pigmented during its production.

Fly Ash Clay Bricks

Fly ash clay bricks are manufactured with clay and fly ash, at about 1,000 degrees C. Some studies have shown that these bricks tend to fail poor produce pop-outs, when bricks come into contact with moisture and water, causing the bricks to expand.

Tests on Bricks

To know the quality of bricks following 7 tests can be performed. In these tests some are performed in laboratory and the rest are on field.

- Compressive strength test
- Water Absorption test
- Efflorescence test
- Hardness test
- Size, Shape and Colour test
- Soundness test
- Structure test

Compressive strength test: This test is done to know the compressive strength of brick. It is also called crushing strength of brick. Generally 5 specimens of bricks are taken to laboratory for testing and tested one by one. In this test a brick specimen is put on crushing machine and applied pressure till it breaks. The ultimate pressure at which brick is crushed is taken into account. All five brick specimens are tested one by one and average result is taken as brick's compressive/crushing strength.

Water Absorption test: In this test bricks are weighed in dry condition and let them immersed in fresh water for 24 hours. After 24 hours of immersion those are taken out from water and wipe out with cloth. Then brick is weighed in wet condition. The difference between weights is the water absorbed by brick. The percentage of water absorption is then calculated. The less water absorbed by brick the greater its quality. Good quality brick doesn't absorb more than 20% water of its own weight.

Efflorescence test: The presence of alkalis in bricks is harmful and they form a grey or white layer on brick surface by absorbing moisture. To find out the presence of alkalis in bricks this test is performed. In this test a brick is immersed in fresh water for 24 hours and then it's taken out from water and allowed to dry in shade. If the whitish layer is not visible on surface it proves that absence of alkalis in brick. If the whitish layer visible about 10% of brick surface then the presence of alkalis is in acceptable range. If that is about 50% of surface then it is moderate. If the alkalis' presence is over 50% then the brick is severely affected by alkalis.

Hardness test: In this test a scratch is made on brick surface with a hard thing. If that doesn't left any impression on brick then that is good quality brick.

Size, shape and colour test: In this test randomly collected 20 bricks are staked along lengthwise, width wise and height wise and then those are measured to know the variation of sizes as per standard. Bricks are closely viewed to check if its edges are sharp and straight

and uniform in shape. A good quality brick should have bright and uniform colour throughout.

Soundness test: In this test two bricks are held by both hands and struck with one another. If the bricks give clear metallic ringing sound and don't break then those are good quality bricks.

Structure test: In this test a brick is broken or a broken brick is collected and closely observed. If there are any flaws, cracks or holes present on that broken face then that isn't good quality brick.

2. CEMENT

Cement is a binder, a substance that sets and hardens and can bind other materials together. Cements used in construction can be characterized as being either hydraulic or non-hydraulic, depending upon the ability of the cement to be used in the presence of water. Non-hydraulic cement will not set in wet conditions or underwater, rather it sets as it dries and reacts with carbon dioxide in the air. It can be attacked by some aggressive chemicals after setting. Hydraulic cement is made by replacing some of the cement in a mix with activated aluminium silicates, pozzolanas, such as fly ash. The chemical reaction results in hydrates that are not very water-soluble and so are quite durable in water and safe from chemical attack. This allows setting in wet condition or underwater and further protects the hardened material from chemical attack (e.g., Portland cement).

Use

- Cement mortar for Masonry work, plaster and pointing etc.
- Concrete for laying floors, roofs and constructing lintels, beams, weather-shed, stairs, pillars etc.
- Construction for important engineering structures such as bridge, culverts, dams, tunnels, light house, clocks, etc.
- Construction of water, wells, tennis courts, septic tanks, lamp posts, telephone cabins etc.
- Making joint for joints, pipes, etc.
- Manufacturing of precast pipes, garden seats, artistically designed wens, flower posts, etc.
- Preparation of foundation, water tight floors, footpaths, etc.

Types of Cements

Many types of cements are available in markets with different compositions and for use in different environmental conditions and specialized applications. A list of some commonly used cement is described in this section:

Ordinary Portland cement

Ordinary Portland cement is the most common type of cement in general use around the world. This cement is made by heating limestone (calcium carbonate) with small quantities of other materials (such as clay) to 1450°C in a kiln, in a process known as calcination, whereby a molecule of carbon dioxide is liberated from the calcium carbonate to form calcium oxide, or quicklime, which is then blended with the other materials that have been included in the mix. The resulting hard substance, called 'clinker', is then ground with a small amount of gypsum into a powder to make 'Ordinary Portland Cement'(often referred to as OPC). Portland cement is a basic ingredient of concrete, mortar and most non-specialty grout. The most common use for Portland cement is in the production of concrete. Concrete is a composite material consisting of aggregate (gravel and sand), cement, and water. As a construction material, concrete can be cast in almost any shape desired, and once hardened, can become a structural (load bearing) element. Portland cement may be grey or white.

- This type of cement use in construction when there is no exposure to sulphates in the soil or ground water.
- Lime saturation Factor is limited between i.e. 0.66 to 1.02.
- Free lime-cause the Cement to be unsound.
- Percentage of (Al_2O_3/Fe_2O_3) is not less than 0.66.
- Insoluble residue not more than 1.5%.
- Percentage of SO_3 limited by 2.5% when $C_3A < 7\%$ and not more than 3% when $C_3A > 7\%$.
- Loss of ignition -4%(max)
- Percentage of MgO-5% (max.)
- Fineness -not less than 2250 cm^2/g .

Rapid hardening Portland cement

- It is firmer than Ordinary Portland Cement
- It contains more C_3S are less C_2S than the ordinary Portland cement.
- Its 3 days strength is same as 7 days strength of ordinary Portland cement.

Low heat Portland cement

- Heat generated in ordinary Portland cement at the end of 3days 80 cal/gm. While in low heat cement it is about 50cal/gm of cement.
- It has low percentage of C_3A and relatively more C_2S and less C_3S than O.P. Cement.
- Reduce and delay the heat of hydration. British standard (B S. 1370 : 1974) limit the heat of hydration of this cement.

Sulphate resisting Portland cement

- Maximum C_3A content by 3.5% and minimum fineness by 2500 cm^2/g .

- Firmer than ordinary portland cement.
- Sulphate forms the sulpho-aluminates which have expansive properties and so causes disintegration of concrete.

Sulphate resisting Portland cement

- For this cement, the slag as obtained from blast furnace is used
- The clinkers of cement are ground with about 60 to 65 percent of slag.
- Its strength in early days is less and hence it required longer curing period. It proves to be economical as slag, which is a Waste product, is used in its manufacture.

Pozzolanic cement

- As per Indian standard, the proportions of Pozzolana may be 10 to 25 % by weight. e.2. Burnt clay, shale, Fly ash.
- This Cement has higher resistance to chemical agencies and to sea water because of absence of lime.
- It evolves less heat and initial strength is less but final strength is 28 days onward equal to ordinary Portland cement.
- It possesses less resistance to the erosion and weathering action.
- It imparts higher degree of water tightness and it is cheap.

White Portland cement

- Grey colour of O.P. cement is due to presence of Iron Oxide. Hence in White Cement Fe₂O₃ is limited to 1 %. Sodium Alumina Ferrite (Cinoline) NaAlF₆ is added to act as flux in the absence of Iron-Oxide. •:
- It is quick drying, possesses high strength and has superior aesthetic values and it also cost less than ordinary Cement because of specific requirements imposed upon the raw materials and the manufacturing process.
- White Cement are used in Swimming pools, for painting garden furniture, moulding sculptures and statues etc.

Coloured Portland

- The Cement of desired colour may be obtained by mixing mineral pigments with ordinary Cement.
- The amount of colouring material may vary from 5 to 10 percent. If this percentage exceeds 10percent, the strength of cements is affected.
- The iron Oxide in different proportions gives brown, red or yellow colour. The coloured Cement are widely used for finishing of floors, window sill slabs, stair treads etc.

Expansive cement

- This type of cement is produced by adding an expanding medium like sulphoaluminate and a stabilising agent to the ordinary cement.
- The expanding cement is used for the construction of water retaining structures and for repairing the damaged concrete surfaces.

High alumina cement

- This cement is produced by grilling clinkers formed by calcining bauxite and lime. It can stand high temperatures.
- It evolves great heat during setting. It is therefore not affected by frost.

Composition of Cement clinker

The various constituents combine in burning and form cement clinker. The compounds formed in the burning process have the properties of setting and hardening in the presence of water. They are known as Bogue compounds after the name of Bogue who identified them. These compounds are as follows: Alite (Tricalcium silicate or C_3S), Belite (Dicalcium silicate or C_2S), Celite (Tricalcium aluminate or C_3A) and Felite (Tetracalcium aluminoferrite or C_4AF).

Tricalcium silicate

It is supposed to be the best cementing material and is well burnt cement. It is about 25-50% (normally about 40 per cent) of cement. It renders the clinker easier to grind, increases resistance to freezing and thawing, hydrates rapidly generating high heat and develops an early hardness and strength. However, raising of C_3S content beyond the specified limits increases the heat of hydration and solubility of cement in water. The hydrolysis of C_3S is mainly responsible for 7 day strength and hardness. The rate of hydrolysis of C_3S and the character of gel developed are the main causes of the hardness and early strength of cement paste. The heat of hydration is 500 J/g.

Dicalcium silicate

It constitutes about 25-40% (normally about 32 per cent) of cement. It hydrates and hardens slowly and takes long time to add to the strength (after a year or more). It imparts resistance to chemical attack. Raising of C_2S content renders clinker harder to grind, reduces early strength, decreases resistance to freezing and thawing at early ages and decreases heat of hydration. The hydrolysis of C_2S proceeds slowly. At early ages, less than a month, C_2S has little influence on strength and hardness. While after one year, its contribution to the strength and hardness is proportionately almost equal to C_3S . The heat of hydration is 260 J/g.

Tricalcium aluminate

It is about 5-11% (normally about 10.5 per cent) of cement. It rapidly reacts with water and is responsible for flash set of finely ground clinker. The rapidity of reaction is regulated by the addition of 2-3% of gypsum at the time of grinding cement. Tricalcium aluminate is responsible for the initial set, high heat of hydration and has greater tendency to volume changes causing cracking. Raising the C_3A content reduces the setting time, weakens

resistance to sulphate attack and lowers the ultimate strength, heat of hydration and contraction during air hardening. The heat of hydration of 865 J/g.

Tetracalciumaluminoferrite

It constitutes about 8–14% (normally about 9 per cent) of cement. It is responsible for flash set but generates less heat. It has poorest cementing value. Raising the C₄AF content reduces the strength slightly. The heat of hydration is 420 J/g.

Hydration of Cement

In the anhydrous state, four main types of minerals are normally present: alite, belite, celite and felite. Also present are small amounts of clinker sulfate (sulfates of sodium, potassium and calcium) and gypsum, which was added when the clinker was ground up to produce the familiar grey powder.

When water is added, the reactions which occur are mostly exothermic, that is, the reactions generate heat. We can get an indication of the rate at which the minerals are reacting by monitoring the rate at which heat is evolved using a technique called conduction calorimetry. Almost immediately on adding water some of the clinker sulphates and gypsum dissolve producing an alkaline, sulfate-rich, solution. Soon after mixing, the (C₃A) phase (the most reactive of the four main clinker minerals) reacts with the water to form an aluminate-rich gel (Stage I on the heat evolution curve above). The gel reacts with sulfate in solution to form small rod-like crystals of ettringite. (C₃A) reaction with water is strongly exothermic but does not last long, typically only a few minutes, and is followed by a period of a few hours of relatively low heat evolution. This is called the dormant, or induction period (Stage II). The first part of the dormant period, up to perhaps half-way through, corresponds to when concrete can be placed. As the dormant period progresses, the paste becomes too stiff to be workable. At the end of the dormant period, the alite and belite in the cement start to react, with the formation of calcium silicate hydrate and calcium hydroxide. This corresponds to the main period of hydration (Stage III), during which time concrete strengths increase. The individual grains react from the surface inwards, and the anhydrous particles become smaller. (C₃A) hydration also continues, as fresh crystals become accessible to water. The period of maximum heat evolution occurs typically between about 10 and 20 hours after mixing and then gradually tails off. In a mix containing OPC only, most of the strength gain has occurred within about a month. Where OPC has been partly-replaced by other materials, such as fly ash, strength growth may occur more slowly and continue for several months or even a year. Ferrite reaction also starts quickly as water is added, but then slows down, probably because a layer of iron hydroxide gel forms, coating the ferrite and acting as a barrier, preventing further reaction.

Products of Hydration

During Hydration process several hydrated compounds are formed most important of which are, Calcium silicate hydrate, calcium hydroxide and calcium aluminium hydrates which is important for strength gain.

Calcium silicate hydrate:

This is not only the most abundant reaction product, occupying about 50% of the paste volume, but it is also responsible for most of the engineering properties of cement paste. It is often abbreviated, using cement chemists' notation, to "C-S-H," the dashes indicating that no strict ratio of SiO₂ to CaO is inferred. C-S-H forms a continuous layer that binds together the original cement particles into a cohesive whole which results in its strong bonding capacity. The Si/Ca ratio is somewhat variable but typically approximately 0.45-0.50 in hydrated Portland cement but up to perhaps about 0.6 if slag or fly ash or microsilica is present, depending on the proportions.

Calcium hydroxide:

The other products of hydration of C₃S and C₂S are calcium hydroxide. In contrast to the C-S-H, the calcium hydroxide is a compound with distinctive hexagonal prism morphology. It constitutes 20 to 25 per cent of the volume of solids in the hydrated paste. The lack of durability of concrete is on account of the presence of calcium hydroxide. The calcium hydroxide also reacts with sulphates present in soils or water to form calcium sulphate which further reacts with C₃A and cause deterioration of concrete. This is known as sulphate attack. To reduce the quantity of Ca(OH)₂ in concrete and to overcome its bad effects by converting it into cementitious product is an advancement in concrete technology. The use of blending materials such as fly ash, silica fume and such other pozzolanic materials are the steps to overcome bad effect of Ca(OH)₂ in concrete. However, Ca(OH)₂ is alkaline in nature due to which it resists corrosion in steel.

Calcium aluminium hydrates:

These are formed due to hydration of C₃A compounds. The hydrated aluminates do not contribute anything to the strength of concrete. On the other hand, their presence is harmful to the durability of concrete particularly where the concrete is likely to be attacked by sulphates. As it hydrates very fast it may contribute a little to the early strength.

Various tests on cement:

Basically two types of tests are under taken for assessing the quality of cement. These are either field test or lab tests. The current section describes these tests in details.

Field test:

There are four field tests may be carried out to ascertain roughly the quality of cement. There are four types of field tests to access the colour, physical property, and strength of the cement as described below.

Colour

- The colour of cement should be uniform.
- It should be typical cement colour i.e. grey colour with a light greenish shade.

Physical properties

- Cement should feel smooth when touched between fingers.
- If hand is inserted in a bag or heap of cement, it should feel cool.

Presence of lumps

- Cement should be free from lumps.
- For a moisture content of about 5 to 8%, this increase of volume may be much as 20 to 40 %, depending upon the grading of sand.

Strength

- A thick paste of cement with water is made on a piece of thick glass and it is kept under water for 24 hours. It should set and not crack.

Laboratory tests:

Six laboratory tests are conducted mainly for assessing the quality of cement. These are: fineness, compressive strength, consistency, setting time, soundness and tensile strength.

Fineness

- This test is carried out to check proper grinding of cement.
- The fineness of cement particles may be determined either by sieve test or permeability apparatus test.
- In sieve test, the cement weighing 100 gm is taken and it is continuously passed for 15 minutes through standard BIS sieve no. 9. The residue is then weighed and this weight should not be more than 10% of original weight.
- In permeability apparatus test, specific area of cement particles is calculated. This test is better than sieve test. The specific surface acts as a measure of the frequency of particles of average size.

Compressive strength

- This test is carried out to determine the compressive strength of cement.
- The mortar of cement and sand is prepared in ratio 1:3.
- Water is added to mortar in water cement ratio 0.4.
- The mortar is placed in moulds. The test specimens are in the form of cubes and the moulds are of metals. For 70.6 mm and 76 mm cubes, the cement required is 185 gm and 235 gm respectively.
- Then the mortar is compacted in vibrating machine for 2 minutes and the moulds are placed in a damp cabin for 24 hours.
- The specimens are removed from the moulds and they are submerged in clean water for curing.
- The cubes are then tested in compression testing machine at the end of 3 days and 7 days. Thus compressive strength was found out.

Consistency

- The purpose of this test is to determine the percentage of water required for preparing cement pastes for other tests.
- Take 300 gm of cement and add 30 percent by weight or 90 gm of water to it.
- Mix water and cement thoroughly.
- Fill the mould of Vicat apparatus and the gauging time should be 3.75 to 4.25 minutes.
- Vicat apparatus consists of a needle is attached a movable rod with an indicator attached to it.
- There are three attachments: square needle, plunger and needle with annular collar.
- The plunger is attached to the movable rod. the plunger is gently lowered on the paste in the mould.
- The settlement of plunger is noted. If the penetration is between 5 mm to 7 mm from the bottom of mould, the water added is correct. If not process is repeated with different percentages of water till the desired penetration is obtained.

Setting time

- This test is used to detect the deterioration of cement due to storage. The test is performed to find out initial setting time and final setting time.
- Cement mixed with water and cement paste is filled in the Vicat mould.
- Square needle is attached to moving rod of vicat apparatus.
- The needle is quickly released and it is allowed to penetrate the cement paste. In the beginning the needle penetrates completely. The procedure is repeated at regular intervals till the needle does not penetrate completely. (upto 5mm from bottom)
- Initial setting time ≤ 30 min for ordinary Portland cement and 60 min for low heat cement.
- The cement paste is prepared as above and it is filled in the Vicat mould.
- The needle with annular collar is attached to the moving rod of the Vicat apparatus.
- The needle is gently released. The time at which the needle makes an impression on test block and the collar fails to do so is noted.
- Final setting time is the difference between the time at which water was added to cement and time as recorded in previous step, and it is ≤ 10 hours.

Soundness

- The purpose of this test is to detect the presence of uncombined lime in the cement.
- The cement paste is prepared.
- The mould is placed and it is filled by cement paste.
- It is covered at top by another glass plate. A small weight is placed at top and the whole assembly is submerged in water for 24 hours.
- The distance between the points of indicator is noted. The mould is again placed in water and heat is applied in such a way that boiling point of water is reached in about 30 minutes. The boiling of water is continued for one hour.
- The mould is removed from water and it is allowed to cool down.

- The distance between the points of indicator is again measured. The difference between the two readings indicates the expansion of cement and it should not exceed 10 mm.

Tensile strength

- This test was formerly used to have an indirect indication of compressive strength of cement.
- The mortar of sand and cement is prepared.
- The water is added to the mortar.
- The mortar is placed in briquette moulds. The mould is filled with mortar and then a small heap of mortar is formed at its top. It is beaten down by a standard spatula till water appears on the surface. Same procedure is repeated for the other face of briquette.
- The briquettes are kept in a damp for 24 hours and carefully removed from the moulds.
- The briquettes are tested in a testing machine at the end of 3 and 7 days and average is found out.

3. CONCRETE

Concrete is a composite material composed mainly of water, aggregate, and cement. Often, additives and reinforcements are included in the mixture to achieve the desired physical properties of the finished material. When these ingredients are mixed together, they form a fluid mass that is easily molded into shape. Over time, the cement forms a hard matrix which binds the rest of the ingredients together into a durable stone-like material with many uses.

The aim is to mix these materials in measured amounts to make concrete that is easy to Transport, place, compact, finish and which will set, and harden, to give a strong and durable product. The amount of each material (ie cement, water and aggregates) affects the properties of hardened concrete.

Production of concrete

A good quality concrete is essentially a homogeneous mixture of cement, coarse and fine aggregates and water which consolidates into a hard mass due to chemical action between the cement and water. Each of the four constituents has a specific function. The coarser aggregate acts as a filler. The fine aggregate fills up the voids between the paste and the coarse aggregate. The cement in conjunction with water acts as a binder. The mobility of the mixture is aided by the cement paste, fines and nowadays, increasingly by the use of admixtures. The stages of concrete production are: Batching or measurement of materials, Mixing, Transporting, Placing, Compacting, Curing and Finishing.

Batching

It is the process of measuring concrete mix ingredients either by volume or by mass and introducing them into the mixture. Traditionally batching is done by volume but most specifications require that batching be done by mass rather than volume. The proportions of various ingredients are determined by proper mix design.

A concrete mix is designed to produce concrete that can be easily placed at the lowest cost. The concrete must be workable and cohesive when plastic, then set and harden to give strong and durable concrete. The mix design must consider the environment that the concrete will be in; ie exposure to sea water, trucks, cars, forklifts, foot traffic or extremes of hot and cold. Proportioning concrete is a mixture of cement, water, coarse and fine aggregates and admixtures. The proportions of each material in the mixture affects the properties of the final

hardened concrete. These proportions are best measured by weight. Measurement by volume is not as accurate, but is suitable for minor projects.

Cement content as the cement content increases, so does strength and durability. Therefore to increase the strength, increase the cement content of a mix. Water Content adding more water to a mix gives a weaker hardened concrete. Always use as little water as possible, only enough to make the mix workable. Water to cement ratio as the water to cement ratio increases, the strength and durability of hardened concrete decreases. To increase the strength and durability of concrete, decrease the water-cement ratio. Aggregates too much fine aggregate gives a sticky mix. Too much coarse aggregate gives a harsh or boney mix. Mixing concrete must be mixed so the cement, water, aggregates and admixtures blend into an even mix. Concrete is normally mixed by machine. Machine mixing can be done on-site or be a pre-mixed concrete company. Pre-mixed concrete is batched (proportioned) at the plant to the job requirements. Truck mixing the materials are normally added to the trucks at batching plants and mixed for required time and speed at the plant. The trucks drum continues to rotate to agitate the concrete as it is delivered to the site. Site mixing when site mixing begin by loading a measured amount of coarse aggregate into the mixer drum. Add the sand before the cement, both in measured amounts.

Mixing

The mixing operation consists of rotation or stirring, the objective being to coat the surface the all aggregate particles with cement paste, and to blind all the ingredients of the concrete into a uniform mass; this uniformity must not be disturbed by the process of discharging from the mixer. The mixing may done by manually or by mechanical means like, Batch mixer, Tilting drum mixer, Non tilting drum mixer, Pan type mixer, Dual drum mixer or Continuous mixers.

There are no general rules on the order of feeding the ingredients into the mixer as this depend on the properties of the mixer and mix. Usually a small quantity of water is fed first, followed by all the solids materials. If possible greater part of the water should also be fed during the same time, the remainder being added after the solids. However, when using very dry mixes in drum mixers it is necessary to feed the coarse aggregate just after the small initial water feed in order to ensure that the aggregate surface is sufficiently wetted.

Compaction

The operation of placing and compaction are interdependent and are carried out simultaneously. They are most important for the purpose of ensuring the requirements of strength, impermeability and durability of hardened concrete in the actual structure. As for as placing is concerned, the main objective is to deposit the concrete as close as possible to its final position so that segregation is avoided and the concrete can be fully compacted. The aim of good concrete placing can be stated quite simply.

It is to get the concrete into position at a speed, and in a condition, that allow it to be compacted properly. To achieve proper placing following rules should be kept in mind: The concrete should be placed in uniform layers, not in large heaps or sloping layers. The thickness of the layer should be compatible with the method of vibration so that entrapped air can be removed from the bottom of each layer. The rate of placing and of compaction should be equal. If you proceed too slowly, the mix could stiffen so that it is no longer sufficiently workable. On no account should water ever be added to concrete that is setting. On the other hand, if you go too quickly, you might race ahead of the compacting gang, making it impossible for them to do their job properly. Each layer should be fully compacted before placing the next one, and each subsequent layer should be placed whilst the underlying layer is still plastic so that monolithic construction is achieved. Collision between concrete and formwork or reinforcement should be avoided. For deep sections, a long down pipe ensures accuracy of location of concrete and minimum segregation. You must be able to see that the placing is proceeding correctly, so lighting should be available for large, deep sections, and thin walls and columns. Once the concrete has been placed, it is ready to be compacted. The purpose of compaction is to get rid of the air voids that are trapped in loose concrete.

It is important to compact the concrete fully because: Air voids reduce the strength of the concrete. For every 1% of entrapped air, the strength falls by somewhere between 5 and 7%. This means that concrete containing a mere 5% air voids due to incomplete compaction can lose as much as one third of its strength. Air voids increase concrete's permeability. That in turn reduces its durability. If the concrete is not dense and impermeable, it will not be watertight. It will be less able to withstand aggressive liquids and its exposed surfaces will weather badly. Moisture and air are more likely to penetrate to the reinforcement causing it to rust. Air voids impair contact between the mix and reinforcement (and, indeed, any other embedded metals). The required bond will not be achieved and the reinforced member will

not be as strong as it should be. Air voids produce blemishes on struck surfaces. For instance, blowholes and honeycombing might occur. There are two methods for compaction which includes: vibration by vibrators or by tamping using tamping rods.

Curing

Curing is the process of making the concrete surfaces wet for a certain time period after placing the concrete so as to promote the hardening of cement. This process consists of controlling the temperature and the movement of moisture from and into the concrete.

Curing of concrete is done for the following purposes. Curing is the process of controlling the rate of moisture loss from concrete to ensure an uninterrupted hydration of Portland cement after concrete has been placed and finished in its final position. Curing also helps maintain an adequate temperature of concrete in its early stages, as this directly affects the rate of hydration of cement and eventually the strength gain of concrete or mortars.

Curing of concrete must be done as soon as possible after placement and finishing and must continue for a reasonable period of time, for the concrete to achieve its desired strength and durability. Uniform temperature should be maintained throughout the concrete depth to avoid thermal shrinkage cracks.

Material properties are directly related to micro-structure. Curing assists the cement hydration reaction to progress steadily and develops calcium silicate hydrate gel, which binds aggregates leading to a rock solid mass, makes concrete denser, decreases the porosity and enhances the physical and mechanical properties of concrete.

Some other purposes of curing can be summed up as: curing protects the concrete surfaces from sun and wind, the process of curing increase the strength of the structure, the presence of water is essential to cause the chemical action which accompanies the setting of concrete. Generally there is adequate quantity of water at the time of mixing to cause the hardening of concrete, but it is necessary to retain water until the concrete is fully hardened.

If curing is efficient, the strength of concrete gradually increases with age. This increase in strength is sudden and rapid in early stages and it continues slowly for an indefinite period. By proper curing, the durability and impermeability of concrete are increased and shrinkage is reduced. The resistance of concrete to abrasion is considerably increased by proper curing.

Curing period:

For ordinary Portland cement, the curing period is about 7 days to 14 days. If rapid hardening cement is used the curing period can be considerably reduced.

Disadvantages of improper curing:

Following are the disadvantages of improper curing of concrete:

The chances of ingress of chlorides and atmospheric chemicals are very high. The compressive and flexural strengths are lowered. The cracks are developed due to plastic shrinkage, drying shrinkage and thermal effects. The durability decreases due to higher permeability. The frost and weathering resistances are decreased. The rate of carbonation increases. The surfaces are coated with sand and dust and it leads to lower the abrasion resistance. The disadvantages are more prominent in those parts of surfaces which are directly exposed or which have large surfaces compared to depth such as roads, canal, bridges, cooling towers, chimneys etc.

Factors affecting evaporation of water from concrete:

The evaporation of water depends upon the following 4 factors: Air temperature, Fresh concrete temperature, Relative humidity and Wind velocity.

From the above mentioned factors it can be concluded environment directly influences the process of evaporation, hence only the fresh concrete temperature can be monitored or supervised by the concrete technologists. The evaporation of water in the first few hours can leave very low amount of water in the concrete hydration, this leads to various shrinkage cracks. Under normal condition the average loss of water varies from 2.5 to 10 N per m² per hour. The major loss occurs in the top 50 mm layer over a period of 3 hours, the loss could be about 5% of the total volume of that layer.

Methods of curing:

While selecting any mode of curing the following two factors are considered:

- The loss of water should be prevented.
- The temperature should be kept minimum for dissipation of heat of hydration.

Methods of curing can be categorised into the following categories:

Water curing-preventing the moisture loss from the concrete surface by continuously wetting the exposed surface of concrete.

Membrane curing-minimizing moisture loss from concrete surface by covering it with an impermeable membrane.

Steam curing-keeping the surface moist and raising the temperature of concrete to accelerate the rate of strength gain.

Water curing is of the following types:

Ponding: most inexpensive and common method of curing flat slabs, roofs, pavements etc. A dike around the edge of the slab, is erected and water is filled to create a shallow pond. Care must be taken to ensure that the water in the pond does not dry up, as it may lead to an alternate drying and wetting condition.

Sprinkling: fogging and mist curing- using a fine spray or fog or moist of water to the concrete can be efficient method of supplying water to concrete during hot weather, which helps to reduce the temperature of concrete.

Wet coverings: water absorbent fabrics may be used to maintain water on concrete surfaces. They must be continuously kept moist so as to prevent the fabrics from absorbing water from the body of concrete, due to capillary action.

Impermeable membrane curing is of following types:-

Formwork: leaving the form work in place during the early age of concrete is an efficient method of curing.

Plastic sheeting: plastic sheets form an effective barrier to control the moisture losses from the surface of concrete, provided they are secured properly and protected from damage. The efficiency of this system can be enhanced by flooding the concrete surface with water, under the plastic sheet.

Membrane curing compounds: Curing compounds are wax, acrylic and water based liquids are spread over the freshly finished concrete to form an impermeable membrane that minimises the loss of moisture from the concrete surfaces. These are cost effective methods of curing where standard curing procedures are difficult to adopt. When applied to cure concrete the time of the application is critical for maximum effectiveness. Too early application dilutes the membrane, whereas too late application results in being absorbed into the concrete. They

must be applied when the free water on the surface has evaporated. For concrete with low w/c ratio, this is not a suitable process.

Steam curing: Steam curing is the process of accelerating the early hardening of concrete and mortars by exposing it to steam and humidity. These types of curing systems are adopted for railway sleepers, concrete blocks, pipes, manhole covers, poles etc. Precast concrete is cured by this method under pressure. Curing in hot and cold weather requires additional attention.

Hot weather: During hot weather, concrete must be protected from excessive drying and from direct wind and sun. Curing materials which reflect sunlight to reduce concrete temperature must be used.

Cold weather: Some problems associated with temperature below 40°C are:

- Freezing of concrete before strength is developed.
- Slow development of concrete strength.
- Thermal stresses induced by the cooling of warm concrete to cooler ambient temperatures

Chemical curing: In this method water is sprinkled over the surface, after adding certain amount of some hygroscopic material (e.g. sodium chloride or calcium chloride). The hygroscopic materials absorb moisture from the atmosphere and thus keep the surface damp.

Alternating current curing: Concrete can be cured by passing alternating current through freshly laid concrete.

Water cement ratio and compressive strength

A cement of average composition requires about 25% of water by mass for chemical reaction. In addition, an amount of water is needed to fill the gel pores. Nearly 100 years ago, Duff Abrams discovered the direct relationship between water-to-cement ratio and strength, i.e., lesser the water used higher the strength of the concrete, since too much water leaves lots of pores in the cement paste. According to Abram's law, *the strength of fully compacted concrete at a given age and normal temperature is inversely proportional to the water – cement ratio*. Here the water-cement ratio is the relative weight of water to the cement in the mixture. For most applications, water-to-cement ratio should be between 0.4 and 0.5 lower for lower permeability and higher strength. In concrete, the trade off, of course, is with workability, since very low water content result in very stiff mixtures that are difficult to place. The water-to-cement ratio is a factor selected by the civil engineer.

Workability

Workability is one of the physical parameters of concrete which affects the strength and durability as well as the cost of labor and appearance of the finished product. Concrete is said to be workable when it is easily placed and compacted homogeneously i.e without bleeding or Segregation. Unworkable concrete needs more work or effort to be compacted in place, also honeycombs &/or pockets may also be visible in finished concrete. Definition of Workability “The property of fresh concrete which is indicated by the amount of useful internal work required to fully compact the concrete without bleeding or segregation in the finished product.”

Factors affecting workability:

- Water content in the concrete mix
- Amount of cement & its Properties
- Aggregate Grading (Size Distribution)
- Nature of Aggregate Particles (Shape, Surface Texture, Porosity etc.)
- Temperature of the concrete mix
- Humidity of the environment
- Mode of compaction
- Method of placement of concrete
- Method of transmission of concrete

How to improve the workability of concrete

- Increase water/cement ratio
- Increase size of aggregate
- Use well-rounded and smooth aggregate instead of irregular shape
- Increase the mixing time
- Increase the mixing temperature
- Use non-porous and saturated aggregate
- With addition of air-entraining mixtures

Workability tests:

There are 4 types of tests for workability. They are slump test, compacting factor test, flow test, and vee bee test

Slump test

The slump test result is a slump of the behavior of a compacted inverted cone of concrete under the action of gravity. It measures the consistency or the wetness of concrete. Metal mould, in the shape of the frustum of a cone, open at both ends, and provided with the handle, top internal diameter 4 in (102 mm), and bottom internal diameter 8 in (203 mm) with a height of 1 ft (305 mm). A 2 ft (610 mm) long bullet nosed metal rod, (16 mm) in diameter. Apparatus Required: Compacting Factor apparatus, Trowels, Graduated cylinder, Balance and Tamping rod and iron bucket

The test is carried out using a mould known as a slump cone or Abrams **cone**. The cone is placed on a hard non-absorbent surface. This cone is filled with fresh concrete in three stages, each time it is tamped using a rod of standard dimensions. At the end of the third stage, concrete is struck off flush to the top of the mould. The mould is carefully lifted vertically upwards, so as not to disturb the concrete cone. Concrete subsides. This subsidence is termed as slump, and is measured in to the nearest 5 mm if the slump is <100 mm and measured to the nearest 10 mm if the slump is >100 mm.

The slumped concrete takes various shapes, and according to the profile of slumped concrete, the slump is termed as true slump, shear slump or collapse slump. If a shear or collapse slump is achieved, a fresh sample should be taken and the test repeated. A collapse slump is an indication of too wet a mix. Only a true slump is of any use in the test. A collapse slump will generally mean that the mix is too wet or that it is a high workability mix, for which slump test is not appropriate. Very dry mixes; having slump 0 – 25 mm are used in road making, low workability mixes; having slump 10 – 40 mm are used for foundations with light reinforcement, medium workability mixes; 50 - 90 for normal reinforced concrete placed with vibration, high workability concrete; > 100 mm.



This test is usually used in laboratory and determines the workability of fresh concrete when size is about 40 mm maximum. The test is carried out as per specification of IS: 1199-1959.

Compacting factor test:

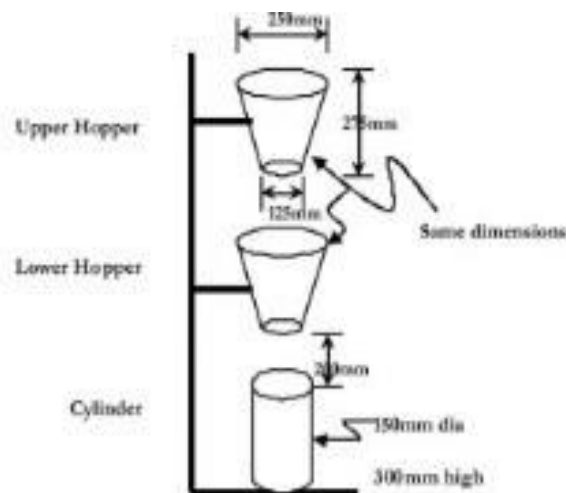

Steps for performing the experiment:

- keep the apparatus on the ground and apply grease on the inner surface of the cylinders.
- Measure the mass as w_1 kg by weighing the cylinder accurately and fix the cylinder on the base in such a way that the central points of hoppers and cylinder lie on one vertical line and cover the cylinder with a plate.
- For each 5 kg of aggregate mixes are to be prepared with water-cement ratio by weight with 2.5 kg sand and 1.25 kg of cement and then add required amount of water thoroughly until and unless concrete appears to be homogeneous.

- With the help of hand scoop without compacting fill the freshly mixed concrete in upper hopper part gently and carefully and within two minutes release the trap door so that the concrete may fall into the lower hopper such that it bring the concrete into standard compaction.
- Fall the concrete to into the cylinder by bringing the concrete into standard Compaction immediately after the concrete has come to rest and open the trap door of lower hopper and then remove the excess concrete above the top of the cylinder by a pair of trowels, one in each hand will blades horizontal slide them from the opposite edges of the mould inward to the center with a sawing motion.
- Clean the cylinder from all sides properly. Find the mass of partially compacted concrete thus filled in the cylinder and say it W2 kg. After this refill the cylinder with the same sample of concrete in approximately 50 mm layers, by vibrating each layer heavily so as to expel all the air and obtain full compaction of the Concrete.
- Struck off level the concrete and weigh and cylinder filled with fully compacted concrete. Let the mass be W3 kg.
- Calculate compaction factor by using the formula: $C.F = \frac{W2 - W1}{W3 - W1}$

Flow Table Test:

The flow table test or flow test is a method to determine the consistence of fresh concrete.

Flow table with a grip and a hinge, 70 centimetres (28 in) square. Abrams cone, open at the top and at the bottom - 30 centimetres (12 in) high, 17 centimetres (6.7 in) top diameter, 25 centimetres (9.8 in) base diameter. Water bucket and broom for wetting the flow table. Tamping rod, 60 centimetres (24 in) long. Conducting the test The flowtable is wetted. The cone is placed in the center of the flowtable and filled with fresh concrete in two equal layers. Each layer is tamped 10 times with tamping rod. Wait 30 seconds before lifting the cone. The cone is lifted, allowing the concrete to flow. The flowtable is then lifted up 40mm and then dropped 15 times, causing the concrete to flow. After this the diameter of the concrete is measured.

Vee-Bee Test:

This test is useful for concrete having low and very low workability. In this test the concrete is moulded into a cone in a cylinder container and the entire set up is mounted on a vibrating table. When vibrator starts, concrete placed on the cone starts to occupy the cylindrical

container by the way of getting remoulded. Remoulding is complete when the concrete surface becomes horizontal. The time required for completion of remoulding since start of vibrator is measured and denoted as vee-bee seconds. This provides a measure for workability. Lesser is the vee-bee seconds more is the workability

4. ARCHES

Arches are structural members used in a building to bridge across the opening of doors, windows, or cupboards etc. to support the weight of the superimposed masonry by arch action.

Arch action;-It consist of small wedge shaped units joint together by mortar.

But arches made of steel and Rcc are builtinsingle unit without the use of wedge shaped units and are used for bridge constructions.

Terms:-

Intrados:-the inner curve of arches

Soffit- Inner surface of arch

Extrados- Externalcurve of arch

Voussoirs-wedge shaped unit forming courses of an arch

Skewback- inclined surface of abutment.it is prepared to receive the arch

Springer - first voussoirs at springing level on either side of arch which is adjacent to skewback

Crown - highest point of extrados

Key - wedge shaped unit at crown of arch. It is made prominent by making it of larger section nad projected above and below the outline of arch.

Abutment - the end support of arch

Piers - intermediate support of an arcade.

Springing point- point from which curve of arch springs

Springing line- imaginary horizontal line joining 2 springing points

Span - clear horizontal distance between supports

Rise - clear vertical distance between highest point on intrados and springing line

Centre- geometrical centre of arch curve

Ring- circular course forming on arch

Depth or height- perpendicular distance between intrados and extrados

Spandril- irregular triangular shape formed between extrados and horizontal line drawn tangent to crown

Haunch- the lower half portion of arch between crown and skewback

Arched - row of arches supporting a wall above and supported by piers

Thickness of soffit- horizontal distance measured perpendicular to the front and back face of an arch

Impost - projecting course at upper part of a pier and abutment to stress the springing line.

The arch may be defined as a mechanical arrangements of wedge shaped blocks of stone or bricks which mutually support each other and entire arch is supported at ends by piers or abutments. The wedge shaped units are so arranged together along a curve line that they balance their own weight by mutual pressure and exert a vertical pressure only which can be sustained by support below.

Stability consideration

- Stability of arches depends on friction between surfaces of voussoirs and cohesion of mortar.
- Stability of arches is endangered by
 - (i) Crushing of arch material
 - (ii) Sliding of voussoirs
 - (iii) Rotation / overturning about an edge
 - (iv) Differential settlement of supports

To maintain the stability or equilibrium of arches, points to be noted

(I) Crushing of arch :-

To prevent crushing of arch material which occurs when thrust at some point of arch creates the safe crushing strength of material, points considered are:-

(a) Size of voussoirs should be adequate to resist anticipated thrust.

(b) For small spans , thickness at arch ring is kept uniform from crown to springing.

$$\text{Thickness of ring} = \frac{1}{12} * \text{span}$$

Or

thickness = 20 cm for span upto 1.5 m

= 30 cm for span between 1.5m to 4m

= 40 cm for span between 4m to 7.5 m

(c) For large spans (> 7 cm) , thickness of arch ring may be increased at springing by about 20% to thickness at crown.

(d) Only first class blocks should be used and for large spans arches may be strengthened by steel reinforced so that safe crushing strength is not exceeded.

(II) Sliding of voussoirs :- To prevent sliding of one over after-:

(a) All bed joints should be perpendicular to the line of the least resistance, normally they are made normal to the curve of arch, where they are nearly perpendicular to the line of least resistance.

(b) Depth of the voussoirs should be adequate to resist the tendency of joints to open and slide upon one after other.

(III) Rotation about wedge :-To prevent this

(a) Line of resistance/thrust at any section should be within middle third of arch height.

(b) Thickness of arch and its curve are so designed that time of thrust atleast fall within the section and crosses each joint away from edge.

(IV) To safeguard against differential settlement :-

(a) Abutments should be sufficiently strong to resist the thrust of arch due to self-weight and superimposed loads.

For abutments of ample size – segment arch is strongest

For smaller size of supports- semi-circular / pointed arch is used

Semi-circular arch is strongest and exerts no thrust on abutments and piers.

(b) Whatever may be the shape of arch, it should be symmetrical to avoid differential settlement of support.

Types of arches

(I) Classification according to no. of centres -: Outline of intrados / soffit may be formed by a single arc / combination of arcs of various radii and centres and so named as one centre, two centred, 3 centred arcs

* **One centred arch**- They have only one centre .The types are semi-circle, segmental arch(less than a semi-circle), horse shoe arch (more than a semi-circle),

Stilted arch (semi-circular with 2 verticals portions at springing's), bulls eye arch (complete circular arch)

* **Two centred arch**- They are

(a) Blunt arch- Both centres are within the arch itself.

(b) Gothic/Equilateral/pointed arch-Radii of arches are equal to span and centres are on springing points.

(c) Acute/laneeet arch-both the centres lie on the springing line but outside the springing points.

* **Three centred arch**-

(a) Elliptical arch-It is the form of semi ellipse, Two centres are used for making up the ends and the third is used to draw the central position.

(b) 3 centred drop arch-procedure here is reversed. Ends of the arch formed by arc, central portion is drawn by the other 2 centres.

***Four centred arch**-Two arch are on the springing line and two are

Below the springing line.

***five centred arch**-It looks like semi-elliptical arch. Its procedure is as following

(i) first draw the springing line and divide into 5 parts.

(ii) With centres as A and B draw arches of radius equal to span intersecting at point C₅. Join C₅ with 2 and 3.and produce indefinitely.

(iii) With centres as C₁ and C₂ and radius 3 divisions(i/e 1-4) draw arches intersecting at 4.

(iv) Join OC₁ and OC₂ intersecting lines C₅-2 and C₅-3 and C₃ and C₄.

(v) points C_1, C_2, C_3, C_4, C_5 are the centre of the arch.

CLASSIFICATION ACCORDING TO SHAPE FORMED BY SOFFIT/INTRADOS:-

(I) **FLAT ARCH** (straight/ square / camber arch):-

The extrados is horizontal and intrados is given a slight rise/camber of about 10 to 15mm/metre width of span so as to allow for slight settlement of it. The angle of skewback with horizontal is usually 60 degree. The depth of the arch is generally kept 3 or 4 courses of brick.

They are limited to span upto 1.5m unless strengthened by steel reinforcement.

(II) **French / Dutch arch**:- Similar in design with flat arch but differs in method of construction. This is not so sound in construction and so used for small inside opening or narrow spans only.

(III) **Semi-circular arch**:- The shape of the arch soffit is a semi-circle. The centre of the arch lies on the springing line.

(IV) **Segmental arch**:- The centre lies below the springing line. The bed joint of voussoirs radiate from the centre of arch. Depth may be 20cm, 30cm or multiple of half brick. Commonly used for arch.

(VI) **Relieving arch**:- Generally constructed over a wooden lintel or over a flat arch. It relieves the load of lintel or flat arch. The ends should be kept inside the solid wall. These days lintels restrict the use of relieving arch.

(VII) **Pointed arch / Gatchic** –It is formed intersection of curves at crown. There are 5 forms of these types of arches, i.e. drop , equilateral , tudor, lancet and venetian.

(VIII) **Venetian arch**:- This one form of pointed arch which has a deeper depth at crown other than arch springing line. It has 4 centres on springing line.

(IX) **Florentine arch**:- Similar to venetian arch except that the intrados consist of a semi circular curve. It has three centres of springing line.

(X) **Semi-circular arch**:- It is formed by more than one centre usually 3 or 5 centres.

(XI) **Horse shoe arch**:- It has a horse shoe like.

(XII)**Stilted arch**:- (a) 2 cusped arch -:This arch with 2 cups has centres at different level. This arch can be made in various forms and used for decorative purposes. This is not structurally efficient.

(c) **Corbel arch**:- It shape justifies its name it does not have arch action. Here each course is cantilevered out over the course below until the two sides meet. This is the oldest form of arch and not used in modern buildings.

CLASSIFICATION ACCORDING TO MATERIALS AND WORKMANSHIP INVOLVED IN CONSTRUCTION

Stone Arch-

Rubble Arch-

*They are made of roughly dressed stones arranged and fitted into a definite arch shape by cement.

*All the stones used may not be of same size and so joints are thicker.

*They are relatively weak and so used for interior types of works.

*Their use is limited to span of 1 m.

*Up to a thickness of 40 cm stones are laid in one ring for full depth .

*for greater thickness than 40 cm two rings alternative courses of header and stretcher.

Ashler Arch-

*Here stones are properly cut and dressed to true wedge shape (i. e voussoirs)

*Up to a depth of 60 cm, voussoirs are made of full thickness of arch and are set in time (cement mortar)

*To know the no. and size of voussoirs and the key stone of arch, a full size arch is first set out on platform level and then sizes of stones are marked on platform after leaving a gap for joints. Templates are made for voussoirs and key stone of required shape, finally stones are cut and dressed to wedge shapes of templates and arch is laid.

*They have good appearance and used for superior work.

*They have laid as heading and stretcher alternatively. When thickness is large, only the stone is made of full thickness of arch ring.

Brick Arch

Rough Brick Arch-

*Made with ordinary bricks, which are not wedge shaped and so joints are wider at extrados than the intrados.

*Generally they are constructed with half brick rings.

*They are cheap, poor in strength and appearance (suitable for concealed work)

Rough Cut Brick Arch-

*Ordinary bricks are roughly cut with a brick laying are to form wedge shaped voussoirs. So joints are not appealing to eyes.

*They are considered not appealing to eyes and so unsuitable for exposed work

*Used where facing brick work is finished with plaster coat.

Gauged Brick Arches

GAUGED BRICK-

*Bricks prepared to exact size and shape of voussoirs by cutting and dressing.

*Joints are very fine, thin and radially.

*Hard bricks can not be used due to difficulty in cutting to true wedge shape.

*So special bricks called rubber bricks are which can be cut and dressed easily to required shape.

*They are cut by saw and finished by rubbing with stone.

*To get thin and fine joint, lime purely is used to bind voussoirs.

PURPOSE MADE BRICKWORK-

*Superior type arch work to get fine and thickness.

*putty lime is used for binding blocks.

Concrete Archery

Precast Concrete Block Archery-

*For small building opening, precast concrete blocks are used in cement mortar for arch construction.

*Concrete blocks for voussoirs, key blocks, skewbacks of required dimension is prepared from concrete mix and cured for 2-weeks. They are without steel reinforcement. They are successful in India for important building and bridges.

Monolithic Concrete Arches-

*They are constructed from cast in-situ concrete with / without reinforcement depending on span and force frequently used for roofing of building, culvert and bridges.

*The construction for small spans and ordinary loads can be made with plane concrete. For large span RCC arches are used.

*For roofing arches, rise of 5 cm for every 30cm of span is allowed when lime concrete is used in arch work.

*Normally arch thickness greater than 15cm up to span of 3m and beyond this 4 cm should be added for each additional 30 cm more.

*Proper frame work and centering is provided to support fresh concrete during construction. Entire work should be kept for at least two weeks.

THRUST LINE

METHOD OF ANALYSIS OF MASONRY ARCHES

Static Approach-

The line containing all the points where the stress resulted at every section of the arch is called thrust line.

*The arch is safe when line of thrust is found to total inside the thickness of the masonry. A classic analysis method using this result involves the use of funicular polygon. This is a graphic method to construct the line of thrust for arches. If the arch is subjected only to vertical loads, then the horizontal component of thrust is constant throughout the whole arch. Nevertheless, the value of this component and its position at the start / end of the element are unknown. Thus the method must be iterative.

Maximum Thrust-

The maximum thrust case is thrust line, or zone of thrust, which takes the intrados once near the crown and the extrados near each springing. This pattern is the response the arch makes to abutments which squeeze together.

Linear Arch / Theoretical Arch / Line Of Thrust

When arch is subjected to given system of loading, the arch shape which follows the shape of the BM diagram for a beam of some span as that of the arch and subjected to some loading as that in the arch is known as linear arch.

*The line of thrust of a portable arch is funicular polygon.

Eddy's Theorem-

In an arch, BM at any point = horizontal thrust * vertical distance between line of thrust and centre line of arch

(BM at any section of an arch is proportional to the ordinate/intercept between the given arch and the linear arch.)

5. CAVITY WALL

A cavity wall or hollow wall is the one which consists of two separate walls called leader or skins with a cavity or gap in between them.

The two leaves of a cavity wall may be of equal thickness if it is a non load bearing.

The internal leaf may be thicker than the external leaf to meet the structural requirements.

Cavity walls are often constructed for giving better thermal insulation to the building.

It also prevents the dampness to enter and act as sound insulation.

The inner and outer skins should not be less than 10cm each(half brick).

ADVANTAGES :-

There is no direct contact between the inner and outer leaves of the wall (except at wall ties). Hence moisture (dampness) can not travel inside the building.

The cavity between the two leaves is full of air which is bad conductor of heat. hence transmission of heat from external face to the inside the room is very much reduced.

Cavity wall have about 25% greater insulating value than the solid walls.

Cavity walls also offer good insulation against sound.

The nuisance of efflorescence is also very much reduced.

They are cheap and economical .

Loads and foundation are reduced because of less solid.

GENERAL FEATURES OF CAVITY WALLS:-

In case of brick cavity wall ,each is half brick thick .such wall is capable of taking load of two storyed of the domestic type , if heavier loads are to be supported ,the thickness of inner leaf can be increased .

The cavity wall should neither be less than 40mm more for more than 100mm in width .

The inner and outer skins are adequately tied together by means of the special walls ties placed in suitable arrangement , at the rate of at least ties to a square meter of wall area .

The ties are staggered .ties must be placed at 300mm vertical intervals at all angles and doors and windows jambs to increase stability .

Since the cavity separates the two leaves of the wall, to prevent moisture to enter , it is essential to provide a vertical damp proof course at window and door reveals .

The damp proof course should be flexible.

PORPOSE FOR PROVIDING A CAVITY WALL:-

1.PREVENTATION OF DAMPNESS:-When cavity wall construction is adopted there is considerable decrease in the prevention of dampness from outside to inside of the building.

2.HEAT INSULATION:-The air in the cavity acts as a non-conductor of heat and hence the uniform temperature is maintained inside the building.

3.SOUND INSULATION:- The considerable portion of external noise is not allowed to enter inside the building by adopting cavity wall construction.

4.LOAD ON FOUNDATION:-Due to less solid thickness of wall the loads on foundation are considerably reduced.

5. EFFLORESCENCE:-The construction of cavity wall results in the reduction of nuisance of efflorescence to a great extent.

6.ECONOMICAL:-In addition to above mentioned advantages, it is found that the construction cost of a cavity wall is 20% less than the construction cost of a corresponding solid wall .

CONSTRUCTION DETAILS OF CAVITY WALL:-

A cavity wall is constructed of two leaves that is inner and outer with a hollow space in between them.

The width of cavity varies from 50mm to 100mm and it stands vertically. The outer is generally of ½ brick thickness and the inner wall may be of ½ of 1 brick thickness.

The two portions of the wall are connected by means of metal ties or specially prepared bonded bricks. The metal ties are generally of wrought iron or mild steel and they are coated with tar or galvanized so as to have protection against rust.

Where corrosion is heavy, the metal ties of copper or bronze may be adopted. The metal ties are placed at a horizontal distance of 900 mm and a vertical distance of 450 mm. The arrangement of ties is kept staggered .

The outer wall is generally constructed in stretcher bond , but it may be constructed in the flemish bond or english garden-wall bond or flemish garden-wall bond by using bats for headers.

As far as possible, there should be no intimate contact between two leaves of the cavity wall.

Construction at base:-

The cavity may be started from the top of foundation concrete & the hollow space, up to a level of about 100mm to 300mm below the damp-proofing course at plinth level, may be filled with plain cement concrete of proportion 1:2:4.

But, as the cavity below damp-proof course does not serve any purpose ,the brickwork up to a level of 100mm to 300mm below the damp-proofing course at plinth level may be constructed solidly.

The increased thickness of wall will also be helpful in supporting the load to be carried by the wall.

Construction at opening:-

In the plan, the cavity is discontinued at the opening such as doors, windows, etc. The jambs of openings for doors and windows are constructed solid either in brickwork or with layers of slates or tiles.

If metal windows are provided, specially prepared metal frames can be used for this purpose.

An inclined flexible D.P.C is provided to act as a bridge over the cavity. the D.P.C should be extend lengthwise beyond the frame for a distance of about 150mm on either side.

Construction at top:-

It is necessary to take adequate steps at top to prevent the entry of dampness to the inside portion of the wall.

The cavity may be constructed up to the coping of the parapet wall or alternatively it may be closed at the bottom of the parapet wall by a damp proofing course.

In case of a pitched roof, the tops of two portions are connected by solid brickwork to support the roof truss and damp-proofing course is inserted immediately below this solid portion.

Ventilation:-

It is necessary to provide enough ventilation to the hollow space of the cavity wall. This is achieved by providing openings at top at bottom of the wall so that a free current of air is established. The openings are to be fitted with gratings so that entry of rats and other varmints to the hollow space is prevented. Sometimes, the air bricks are used for this purpose.

Shape and slope of ties:-

The metal ties which are used to connect the outer and inner portions should be so shaped and placed that water from outer portion does not pass along inner portions. They should thus be sloped away from the inner portion.

Dropping of mortar, bats etc.:-

During construction of a cavity wall, it should be seen that mortar , bats, etc., do not fall in the hollow space. The presence of such material in the hollow space seriously affects the working of a cavity wall. For this purpose, a wooden strip of width slightly less than that of the hollow space, is supported on ties and it is raised as the work proceeds. Also, some bricks at the bottom are left out and bats, etc. Falling in the cavity are removed from these holes. When the work is completed, this bottom portion is sealed by filling it with bricks. It also be seen that the vermins or mosquitoes do not find access in the cavity.

Design:-

The outside portion of a cavity wall should be treated only as a protecting skin and not as a member of a load bearing wall. The inside portion should have sufficient thickness to carry safely the load coming on it.

6. STAIRS

The means of communication between various floors is offered by various structures such as stairs, lifts, ramps, ladders, escalators.

STAIR: A stair is a series of steps arranged in a manner as to connect different floors of a building. Stairs are designed to provide an easy and quick access to different floors.

- A staircase is an enclosure which contains the complete stairway.
- In a residential house stairs may be provided near the entrance.
- In a public building, stairs must be from main entrance and located centrally.

STAIRCASE: Room of a building where stair is located.

STAIRWAY: Space occupied by the stair.

TECHNICAL TERMS

1. **BALUSTER:** Vertical member which is fixed between stairway and horizontal to provide support to hand rail.
2. **BALUSTRADE:** Combined framework of baluster and hand rail.
3. **STRING:** Inclined member of a stair which supports ends of steps. They are of two types, (i) cut/open string, (ii) closed/housed string.
 - In open string, upper edge is cut away to receive the ends of steps.
 - In closed string, the ends of steps are layed between straight and parallel edges of the string.
4. **FLIGHT :** Unbroken series of steps between the landings.
5. **GOING:** horizontal distance between faces of two consecutive risers.
6. **HANDRAIL:** inclined rail over the string. Generally it is moulded. It serves as a guard rail. It is provided at a convenient height so as to give grasp to hand during ascent and descent.
7. **HEAD ROOM:** vertical distance between nosings of one flight and the bottom of flight immediately above is called head room.
8. **LANDING:** horizontal platform between two flights of a stair. A landing facilitates change of direction and provides an opportunity to take rest.
9. **NEWEL POST:** vertical member placed at ends of flights to connect ends of string and hand rail.
10. **NOSING:** projection part of tread beyond face of riser.
11. **LINE OF NOSING:** imaginary line parallel to strings and tangential to nosings. The underface of hand rail should coincide with line of nosing.
12. **PITCH:** angle of inclination of stair with floor.
Angle of inclination of line of nosing with horizontal.
13. **RISE:** vertical distance between two successive treads.
14. **RISER:** vertical member of the step, which is connected to treads.

15. RUN: length of a stair in a horizontal plane which includes length of landing.
16. SCOTIA: an additional finish provided to nosing to improve the elevation of the step which also provides strength to nosing.
17. SOFFIT: under surface of a stair. Generally it is covered with ceiling or finished with plaster.
18. STEP: combination of tread and riser. Different types are.
 - Commode steps: it has curved riser and tread
 - Dancing step: they don't radiate from a common centre
 - Flier: ordinary step of rectangular shape in plan
 - Round ended step: similar to bullnose step except that its ends are semi-circular in plan
 - Splayed step: it has either one end/both ends splayed in plan
 - Winder : this is a tapering step and is used to change the direction of a flight. The winders radiate from a common centre.
 - Tread: horizontal upper portion of a step.
 - Waist: thickness of structural slab in RCC stair
 - Carriage: a rough timber supporting steps of wooden stairs

REQUIREMENT OF GOOD STAIRCASE

- Stairs should be so located that it is easily accessible from the different rooms of a building.
- It should have adequate light and proper ventilation.
- It should have sufficient stair width to accommodate no. of persons in peak hour/emergency.

Generally for interior stairs, clear width may be

- ✓ at least 50cm in one/two family dwellings
- ✓ at least 90cm in hotels, motels, apartment and industrial building
- ✓ at least 1.1m for other types like hospitals, temples etc.
- No. of steps in a flight should be restricted to a maximum of 12, minimum of 3.
- Ample head room should be provided for tall people to give feeling of spaciousness. It should be minimum of 2.15m.
- Risers and treads sizes should be provided from common point view.

Tread = 2.5cm – 32.5 cm (wide), excluding nosing.

Tread < 25cm, should have a nosing of about 2.5cm

Comfortable height of riser = 17.5cm-18.5cm.

- ✓ Riser * tread = (400-410). 426
- ✓ Riser + tread = (42.5-43.5) 40-45
- ✓ 2(riser) + tread = 60-64 cm 60

Take rise = 14cm, going = 30cm. for each 2cm subtracted from going, add 1cm to rise.

- Stair width depends on purpose and importance of building.
- No. of stairways required should be controlled by maximum floor area contributory to stairway.

(No. of persons using stairs/floor/55cm stairwidth)

should be 15 for hospital and nursing home.

Should be 30 for institutional and residential building

Should be 45 for storage building

Should be 60 for mercantile, educational, industrial building, theatres, restaurants.

Should be 80 for church concert hall, museum

Should be 320 for stadium and amutementstructures.

- Minimum width of landing = width of stair
- Maximum and minimum pitch should be 40° and 25° .
- Winder should be provided at lower end of flight when it is essential. Use of winder should be avoided.
- Live load to be considers n stairs have been stipulated by IS 875-1964
- Stairs and landings should be designed for live load of 3000kg/m^2 in building where there are no possibilities of overcrowding in public building and warehouses where overcrowding is likely live load may be taken as 500kg
- Railing should be design for horizontal force of 55 and vertical force of 70 applied at top of rail

TYPES OF STAIRS

1. Straight stair:

- Here there is no change in the direction of any flight between two successive floors.
- It can be straight run with a single flight between floors or a series of flights without change indirection

Parallel stairs

Angle stairs

Scissors stair

- Straight stair can have a change in direction at any intermediate landing.
- In parallel stair, there is complete reversal of direction occurs.
- In angle stair, successive flights are at an angle to each other.
- Scissor stairs are comprised of a pair of straight runs in opposite direction and are placed on opposite sides of a fire resistive wall.

2. Turning stairs:

- Quarter turn stair :
 - ✓ Provided where flight direction is to be changed by 90^0
 - ✓ Change in direction can be affected by either introducing a quarter space landing or by providing winders at junctions.
- Half turn stair:
 - ✓ They change their direction through 180^0 . They can be dog legged and open newel.
 - ✓ In doglegged stair, flights are in opposite direction and no space is provided between the flights.
 - ✓ In open newel stair, there is a well/opening between flights and may be used to accommodate lift.
 - ✓ Open newel stairs are used at places where sufficient space is available.
- Three quarter turn stair:
 - ✓ They change in the direction through 270^0 or direction is changed with its upper flight crossing the bottom one.
 - ✓ In this type an open well is formed.

3. Circular stair:

- When viewed from above, appear to follow a circle with a single centre of curvature and large radius.
- Generally they are provided at the rear of a building to the access for serving at various floors.
- All the steps radiate from a newel post in the form of winders.
- Made up of stone, cast iron/RCC.

4. Spiral stairs:

- Similar to previous one except that the radius of curvature is small and the stair may be supported by a centre post.
- Over all diameter range from 1-2.5m

5. Curved stair:

- When view from above appear to follow a curve with 2 or more centre of curvature, such as ellipse.

6. Geometric stair:

- They have no newel post are of any geometric shape.
- The change in direction is achieved through winders.
- They needs more skills for its construction and are weaker than open newel stairs
- Here the open well between forward and backward flights is curved.

7. Bifurcated stair:

- So arranged that there is a wide at the start and subdivided into narrow flights at mid landing.
- The two narrow flights start from either side of mid landing.
- They are suitable for modern public buildings.

CLASSIFICATION OF STAIRS BASED ON MATERIALS OF CONSTRUCTION

General materials used in construction of stairs are

- Wooden
- Stone
- Brick
- Metals/steel
- Plane concrete
- RCC
- Wooden stair
 - As they are light in weight, mostly used for residential building.
 - The main objection to this stair is that it is easily attacked by fire and thus, in fire, the occupants of upper floor can't escape.
 - If it is made from good timber like Teak, and thickness is about 45mm, it becomes sufficiently fire proof and allows enough time for occupants on upper floor to escape.

Factors to be considered here are,

- ✓ The string supporting ends of wooden steps may be a cut string/closed string.
- ✓ Scotia blocks may be provided to give additional finish to wooden steps.
- ✓ Small triangular wooden blocks called glue blocks may be provided at inner angle formed between a trade and riser, to provide additional strength.
- ✓ A metal strip may be provided on nosing of wooden step to increase its resistance against wear and tear.
- ✓ The landing may be formed by providing wooden beams of suitable sizes.
- ✓ Sometimes risers are omitted. trades are housed in strings and soffit is covered with wooden battens/metal sheets.
- ✓ The timber used should be free from fungal decay, insect attack, or any defect. Edges may be finished smooth and excess light timber should not be used.
- Metal Stair
 - They are not frequently/commonly used stairs.
 - The external fireescape stairs are generally made of metal.
 - Common metals are CI, bronze, and mild steel.
 - Widely used in factories, workshop, and godowns.

Main features are,

- ✓ Stringers are usually of channel section
- ✓ Tread and riser of a step may be of one unit or may not be

- ✓ Tread and risers are supported on angles, which are connected to stringers.
 - ✓ Risers may be totally omitted.
 - ✓ Spirals stairs of CI consists of CI newel fixed in center around which the CI steps are fixed.
 - ✓ For metal stairs metal balusters with pipe handrail are used.
- RCC Stair
 - Commonly used in all type of construction.
 - They resist better fire and wear than any other material and can be moulded to desired shape.
 - The step can be provided with suitable finishing material such as marble, terrazzo, tiles etc.
 - They can be easily maintained, strong, durable and pleasing in appearance.
 - They can be designed for greater widths and layer spans.
 - The steps may cast in situ/pre cast.
 - It is possible to pre cast a flight and place it in position by equipments.

The materials can be used together/combination with each other to form COMPOSITE STAIRS.

7. FIRE-RESISTING CONSTRUCTION

A fully fire resistant building is fully protected against any fire which occur in its contents.

Causes of Fire: The causes of various types of fire hazards are described in details:

- **Electrical hazards:** Damaged wiring, Damaged plugs, Damp or wet wires, Overloaded motors, Broken switches, outlets or sockets, Problems with lighting fixtures, Faulty heating elements, Overloaded circuits, Liquids near computers, Computers without surge protectors.
- **Housekeeping hazards:** Piles of scrap, waste materials, and trash; Sawdust, metal or plastic powder that can form an explosive mixture with air; Obstructed aisles, Blocked emergency exits, Material covering up fire extinguishers, exit signs, and alarms; Blocked sprinkler heads.
- **Friction hazards:** Hot bearings, Misaligned or broken machine parts, choking or jamming materials, Poor adjustment of moving parts, Inadequate lubrication.
- **process or operation-related hazards:** Cutting and welding operations, which use open flames and produce sparks; Molten metal, which can ignite combustibles or fall into cracks and start a fire that might not erupt until after the work is done; Processes that heat materials to high temperatures; Drying operations where materials in dryers can overheat; Grinding operations that produce sparks and dust; Processes in which flammable vapors are released
- **Storage hazards:** Materials stacked too high blocking sprinkler heads (need 18-inches clearance from head); Flammable or combustible materials stored too close to heat sources; Flammable materials not stored in special containers and cabinets Inadequate ventilation in storage areas; Materials that might react with one another stored together; Materials stored in damaged containers; Materials stored in unlabeled containers; Containers not tightly sealed
- **Smoking hazards:** Ignoring "No Smoking" signs; Smoking around flammable or combustible materials; Throwing matches and cigarettes or cigars on tables or workbenches; Tossing butts on the floor or grass without properly extinguishing them in

an ashtray or ash can; Tossing lighted butts or matches out windows or doors; Smoking in bed; Leaving a cigarette/cigar unattended; Smoking in areas where there is an accumulation of sawdust, plastic or metal powders that may become explosive.

Fire Load: It is the amount of heat liberated in KJ/m^2 of floor area of any component by the combustion of the content of and any combustible part of building itself. The classification of fire load as per BIS: 1641-1960 are as follows:

1. Low fire load: not exceeding $1.15 \times 10^6 \text{ KJ/m}^2$
2. Moderate fire Load: $1.15 \times 10^6 \text{ KJ/m}^2$ to 2.30×10^6
3. High fire Load: $2.23 \times 10^6 \text{ KJ/m}^2$ to 4.60×10^6

Limiting Fire Load:

1. Providing fire Fighting Equipment
2. Using fire resistant materials for construction
3. Providing suitable means of escape
4. Protection of openings

Characteristics of fire resisting materials:

- The composition of the material should be such that it does not become disintegrated under the effect of great heat.
- The expansion of the material due to heat should not be such that it leads to instability of the structure.
- The contraction of the material due to the sudden cooling with water after it has not been heated to a high temperature should not be rapid.

Fire resisting properties of common building materials:

Fire resisting properties of common building materials such as stone, brick, glass, steel and concrete are described below:

- a. Stone:** stone is a bad conductor of heat and it is also a non-combustible material; however, it suffers appreciable under effect of fire. Moreover, the stone is also liable to disintegrate in to small pieces when heated and suddenly cooled.
- b. Brick:** Bricks are not seriously affected until very high temperatures around 1200°C to 1300°C are reached. This is due to the fact that a brick is poor conductor of heat.

- c. **Cast-iron:** The material files in to pieces when heated and suddenly cooled. Therefore, when this material in construction. It is covered either by brickwork of one- brick thickness or any other fire resisting material such as construction.
- d. **Timber:** Generally, the structural elements made of timber ignite and get rapidly destroyed in case of fire. To increase the timber more fire resisting, the surfaces of timbers are coated with chemicals such as ammonium phosphate and sulphate, borax and boric acid, zinc chloride.
- e. **Glass:** The materials are poor conductor of heat and its expansion due to heat is small. The cracks are formed in this material when heated and suddenly cooled.
- f. **Wrought- iron:** This material is rarely used as structural as present. It behaves more or less in the same way mild steel.
- g. **Aluminium:** Very good conductor of heat, it possess poor fire resisting properties.
- h. **Asbestos Cement:** this is non-combustible building material with low coefficient of expansion. It therefore possesses high fire resisting property than other material.

Fire Protection System: The system which protects a large area from fire by using components such as pipes, pump sets, control panel, sprinklers or nozzles etc., is known as fire protection system.

1. **Automatic sprinkler system:** Most reliable automatic means of fire fighting. It involves automatic sprinklers attached to a piping system containing water under pressure and connected to a water supply so that water is discharged immediately sprinkler opened by fire.
2. **Carbon dioxide system:** It extinguishes fire by diluting flammable mixture of air and flammable gas or vapour to proportions below their flammable limits.
3. **Dry Chemical system:** This system includes a supply of dry chemical, an excellent gas such as compressed nitrogen detection devices, release mechanism, fixed piping and nozzles for discharging the dry chemical into hazard area.
4. **Foam System:** In this system, the mechanical foam is formed by passing foam producing liquid and water through adequate device. The foam is as aggregate of air filled bubbles. It is lighter than flammable liquids and oils. The principal components of this system include proportioning apparatus, concentrated storage tank, water supply, foam maker or spray foam-heads, heat detecting devices, automatic and manual actuation devices and an alarm system.

5. **Holon System:** This indicates a specific family of chemicals which are produced by replacing one or more hydrogen atoms with halogen atoms. This is contained in cylinders under pressure in liquid state and it is released through nozzles on piping distribution arrangement. An actuator is provided a cylinder control valve and it is operated either by electric or pneumatic signal when fire occurs.
6. **Hydrant system:** in this system, the hydrants are located at suitable points and they can be operated at suitable points and they can be operated manually or automatically.
7. **Water Spray System:** The water spray system used for fire extinguish depends upon the type of spray and can be sprayed in two categories:
 - Multi-fire system: water is sprayed in high velocities
 - Protective System: Fine water spray of low discharge velocity

Various types of Fire-resisting construction:

The type and age of construction are crucial factors to consider when assessing the adequacy of existing escape routes. To ensure the safety of people it may be necessary to protect escape routes from fire. In older premises it is possible that type of construction and materials used may not perform to current fire standards and refurbishments may have led to:

- Cavities and voids being created, allowing the potential for the unseen spread of fire.
- Doors and hardware being worn by age and movement being less likely to limit the spread of fire and smoke.
- Damaged or insufficient cavity barriers in modular building construction (e.g. CLASP or SCOLA type construction).
- Breaches in fire compartment walls, floors and ceilings created by the installation of new services, (e.g. computer services).

Where an escape route requires the provision of fire resisting construction (e.g. dead end corridors or protected stairways) the following should be ensured:

- Doors (including access hatches to cupboards, ducts and vertical shafts linking floors), walls, floors and ceilings protecting escape routes should be capable of resisting the passage of flame and smoke for long enough for people to escape from the building (normally 30 min).
- Where false ceilings are provided, fire resistance should extend up to the floor slab above (for means of escape purposes 30min fire resistance is required).

- Cavity barriers, fire stopping and dampers in ducts are appropriately installed as required.

General

The materials from which your premises are constructed may determine the speed with which a fire may spread, affecting the escape routes that people will use. A fire starting in a building constructed mainly from readily combustible material will spread faster than one where modern fire-resisting construction materials have been used. Where non-combustible materials are used and the internal partitions are made from fire-resisting materials, the fire will be contained for a longer period, allowing more time for the occupants to escape.

Because of the requirements of the Building Regulations you will probably already have some walls and floors that are fire-resisting and limitations on the surface finishes to certain walls and ceilings.

You will need to consider whether the standard of fire resistance and surface finishing in the escape routes is satisfactory, has been affected by wear and tear or alterations and whether any improvements are necessary.

The following paragraphs give basic information on how fire-resisting construction can provide up to 30 minutes protection to escape routes. This is the standard recommended for most situations. If you are still unsure of the level of fire-resistance that is necessary after reading this information, you should consult a fire safety expert.

Fire resisting construction

The fire resistance of a wall or floor is dependent on the quality of construction and materials used. Common examples of types of construction that provide 30-minute fire resistance to escape routes if constructed to the above standards are:

- Internal framed construction wall, non-load bearing, consisting of 72mm x 37mm timber studs at 600mm centres and faced with 12.5mm of plasterboard with all joints taped and filled.
- Internal framed construction, non load-bearing, consisting of channel section steel studs at 600mm centres faced with 12.5mm of plasterboard with all joints taped and filled;

- Masonry cavity wall consisting of solid bricks of clay, brick earth, shale, concrete or calcium silicate, with a minimum thickness of 90mm on each leaf.

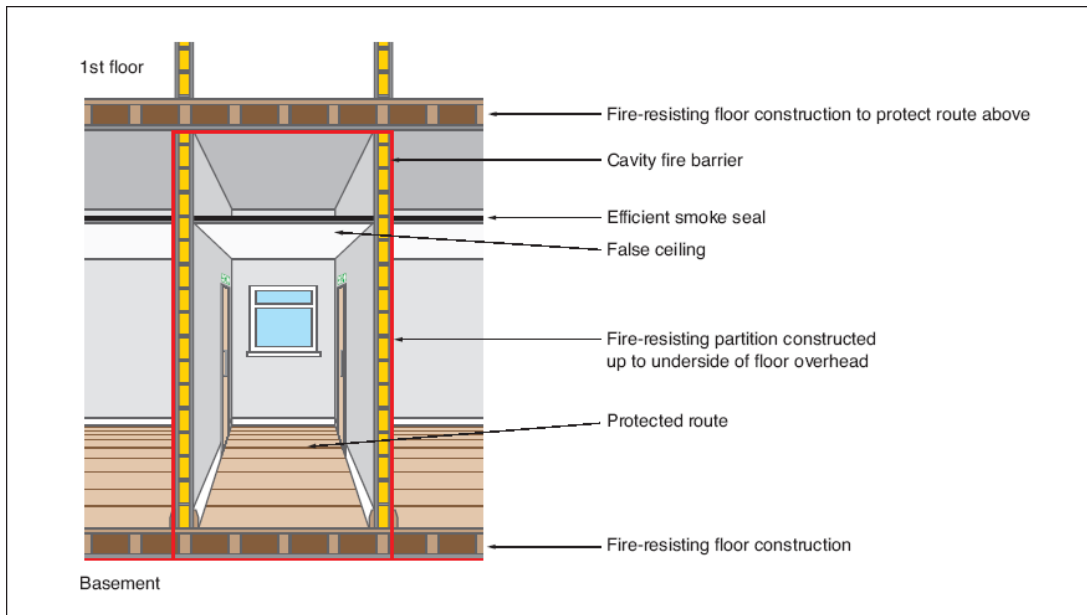

Figure 1: Fire-resisting construction

There are other methods and products available that will achieve the required standard of fire resistance and may be more appropriate for the existing construction in your premises. If there is any doubt about how your building is constructed, then ask for further advice from a competent person.

Fire-resisting floors

The fire resistance of floors will depend on the existing floor construction as well as the type of ceiling finish beneath. If you need to upgrade the fire resistance of your floor it may not be desirable to apply additional fire resistance to the underside of an existing ornate ceiling. In older buildings there may be a requirement to provide fire resistance between beams and joists.

A typical example of a 30-minute fire-resisting timber floor is tongue and groove softwood of not less than 15mm finished thickness on 37mm timber joists, with a ceiling below of one layer of plasterboard to a thickness of 12.5mm with joints taped and filled and backed by supporting timber.

There are other, equally valid, methods and products available for upgrading floors. If you are in any doubt you should ask the advice of a competent person and ensure that the product is installed in accordance with instructions from the manufacturer or supplier.

Fire resisting glazing

The most common type of fire-resisting glazing is 6mm Georgian wired glazing, which is easily identifiable. Clear fire-resisting glazing is available and can quickly be identified by a mark etched into the glass, usually in the corner of the glazed panel, to confirm its fire-resisting standard.

Although this is not compulsory, the marking of glass is supported by the Glass and Glazing Federation, you should check whether the glazing would be marked accordingly before purchase.

The glazing should have been installed in accordance with the manufacturer's instructions and to the appropriate standard, to ensure that its fire-resisting properties are maintained.

The performance of glazed systems in terms of fire resistance and external fire exposure should, wherever possible, be confirmed by test evidence. Alternatively, where there is a lack of test information, ask for an assessment of the proposed construction from suitably qualified people.

Fire separation of voids

A common problem encountered with fire separation is fire-resisting partitions, which do not extend above false ceilings to true ceiling height. This may result in unseen fire spread and a loss of vital protection to the escape routes. It is important therefore to carefully check all such partitions have been installed correctly.

CLASP and SCOLA type construction

CLASP (Consortium of Local Authorities Special Programme) and SCOLA (Second Consortium of Local Authorities) are total or systematic methods of construction that were developed to provide consistent building quality, while reducing the need for traditional skilled labour. They consist of a metal frame upon which structural panels are fixed. This results in hidden voids through which fire may spread.

It is important that cavity barriers that restrict the spread of fire are installed appropriately, especially to walls and floors that need to be fire resisting. If you are in any doubt as to whether any remedial work will be required, then ask for advice from a competent person.

Breaching fire separation

To ensure effective protection against fire, walls and floors providing fire separation must form a complete barrier, with an equivalent level of fire resistance provided to any openings such as doors, ventilation ducts, pipe passages or refuse chutes.

The passing of services such as heating pipes or electrical cables through fire-resisting partitions leaves gaps through which fire and smoke may spread. This should be rectified by suitable fire stopping and there are many proprietary products available to suit particular types of construction. Competent contractors should install such products.

Décor and surface finishes of walls, ceilings and escape routes

The materials used to line walls and ceilings can contribute significantly to the spread of flame across their surface. Most materials that are used as surface linings will fall into one of three classes of surface spread of flame. The following are common examples of acceptable materials for various situations:

Class 0: Materials suitable for circulation spaces and escape routes

- Such materials include brickwork, block work, concrete, ceramic tiles, plaster finishes (including rendering on wood or metal lathes), wood-wool cement slabs and mineral fibre tiles or sheets with cement or resin binding.

Note: Additional finishes to these surfaces may be detrimental to the fire performance of the surface and if there is any doubt about this then consult the manufacturer of the finish.

Class 1: Materials suitable for use in all rooms but not on escape routes

- Such materials include all the Class 0 materials referred to above. Additionally, timber, hardboard, block-board, particle board, heavy flock wallpapers and thermosetting plastics will be suitable if flame-retardant treated to achieve a Class 1 standard.

Class 3: Materials suitable for use in rooms of less than 30m²

- Such materials include all those referred to in Class 1, including those that have not been flame-retardant treated and certain dense timber or plywood and standard glass-reinforced polyesters.

Strong room construction:

This type of construction is adopted to protect important documents, wealth, currency notes from fire and thieves. Followings are important features of a strong room construction.

1. The walls, floors and ceilings of strong room are constructed with minimum thickness of 30 mm.
2. Grills are to be placed in such a way that no gap is left.
3. Special precautions are to be exercising doors, windows, and ventilators of strong room.

8. PLASTERING

Applying mortar coats on the surfaces of walls, columns, ceiling etc. to get smooth finish is termed as plastering. Mortar used for plastering may be lime mortar, cement mortar or lime-cement mortar. Lime mortar used shall have fat lime to sand ratio of 1: 3 or 1: 4. If hydraulic lime is used mix proportion (lime: sand) is 1 : 2. Cement mortar of 1: 4 or 1: 6 mix is very commonly used for plastering, richer mix being used for outer walls. To combine the cost effectiveness of lime mortar and good quality of cement mortar many use lime-cement mortar of proportion (cement : lime : sand) of 1 : 1 : 6 or 1 : 1 : 8 or 1 : 2 : 8.

The objectives of plastering are:

1. To conceal defective workmanship
2. To give smooth surface to avoid catching of dust
3. To give good appearance to structure
4. To protect the wall from rain water and other atmospheric agencies
5. To protect surfaces against vermit.

Requirement of good plaster are:

- It should adhere to the background easily.
- It should be hard and durable.
- It should prevent penetration by moisture.
- It should be cheap and economical.
- It should possess good workability.
- It should efficiently check entry or penetration of moisture from surface.

Materials for plastering:

Lime mortar is usually applied in 3 coats while cement mortar is applied in two or three coats for the stone and brick masonry. For concrete surfaces cement mortar may be applied in two or three coats. For concrete building blocks many times only one coat of cement mortar is applied. The first coat provides means of getting level surface. The final coat provides smooth surface. If three coats are used second coat is known as floating coat. The average thickness of first coat is 10 to 15 mm. Middle coat thickness is 6–8 mm. The final coat is just 2 to 3 mm

thick. If single coat is used its thickness is kept between 6 to 12 mm. Such coats are used on concrete surfaces not exposed to rain. The mortar used for plastering work can be classified into three categories:

- **Lime mortar:** it consists of equal volume of lime and sand these two materials are carefully ground in mortar mill. Flat lime is recommended for plastering work.
- **Cement mortar:** the cement mortar consists of one part of cement to four part of clean, coarse and angular river sand. The materials are thoroughly mixed in dry condition before water is added to them. The mixing of materials is done on a watertight platform.
- **Water proof mortar:** This mortar is water proof and it is prepared by mixing one part of cement and two parts of sand and pulverised alum at the rate of 120 N per m³ sand.

Method of Plastering:

The plastering could be done on the surfaces either in one, two and three coats. The plasterings for two coats are as follows:

- The mortar joints are raked out to a depth of 20 mm and surface is cleaned and well watered. If it is found that the surface to be plastered is very rough and uneven, a primary coat is applied to fill up the hollows before the first coat of plaster is put on the surface.
- The first coat of plaster is now applied on the surface. The usual thickness of first coat for brick masonry is 9 mm to 10 mm. In order to maintain uniform thickness, the screeds are formed on the wall surface by fixing dots.
- The cement mortar is placed between successive screeds and surface is properly finished. The second coat is applied after six hours and thickness of second coat is 3 mm to 2 mm. The completed work is allowed to rest for 24 hours and then, the surface is kept well watered for rest of week.

For plastering in three coats are similar to two coats. The thickness of first coat (rendering coat) 9 to 10 mm, second coat (rendering coat) 9 to 10 mm, and third coat (setting coat) thickness around 3 mm.

The techniques for plastering various surfaces:

- **Internal Plastering on surfaces of Brick and Concrete:**

Initially, the Surface where plastering is to be done will be cleaned. Level pegs on walls will be fixed with reference to the off lines to brick walls set out in floors. (Using centre plumb bob and nylon thread). All the brick walls will be watered before pasting mortar on walls. First coat mortar filling (1:4 Cement and Sand) up to 15 mm will be applied on surfaces where required mortar thickness exceed 25mm. Walls and columns will be plastered 1:4 Cement and Sand to achieve semi rough finished surface. Vertical joint of structural columns / walls & brick walls will be treated by fixing 200mm width chicken mesh with wire nails / concrete nails by centering the mesh to the vertical wall joint. All the embedded service lines and provisions (Conduits, Boxes and etc.) will be completed on brick walls and check with the MEP drawings. Joints between walls and beams will be formed up to a maximum of 20mm and will be sealed using 30 minutes fire rated flexible filler. (Material descriptions will be submitted for the approval of the Engineer) Internal plastering on surfaces of concrete columns, beams & walls which are aligned with surfaces of brick walls will be plastered and other concrete surfaces will be finished with cement base easy plaster. (Material descriptions will be submitted for the approval of the Engineer).

- **External Wall Plastering:**

Alignment and fixing level pegs on external wall surfaces will be done using the surveying instrument / centre plumb bobs. Projections on the wall surfaces will be chipped off and cleaned after completing the level pegs on walls. First coat mortar filling (1:4 Cement and Sand) up to 15 mm will be applied on surfaces where required mortar thickness exceed 25mm. Cement paste on concrete surfaces will be applied to improve the bonding of plaster to the concrete surfaces. Maximum width of 20mm horizontal grooves between walls and beams will be formed by cutting using grinders with diamond wheels after plastering the wall surface. This groove will be filled with approved weather sealant. External wall plaster will be finished with rough surface. 1:10 slope at the external side of the window sill will be formed while plastering the window reveals.

- **Soffit Plastering / Soffit Finishing with Cement Based Easy Plaster**

The slab soffits and beams' sides and soffits which are to be smooth surfaced painted finished will be smoothen with easy plaster (Material literature will be submitted separately) and places where concrete surfaces are uneven, will be roughen & leveled with cement and sand mortar plaster before applying easy plaster to make surface smooth.

- **Improving Joints of Brick Wall & Structural Concrete**

- 200mm wide Chicken Mesh will be fixed at the joint.
- Concrete surfaces will be washed and cleaned.
- Concrete surface which are to be plastered will be roughen or put spot cement slurry.

Different plastering techniques:

- There are numerous plastering techniques used to plaster ceilings and walls. It all depends on the requirements of the client as well as the nature of the area that needs plastering. Let's take a look at some general plastering techniques:

Dry Lining Plastering

- Over the years, traditional Melbourne homes made use of wet plastering to ensure a smooth finish to ceilings and walls. During the last 3 to 4 decades, dry plastering or dry lining plastering techniques are being used instead. This method is favoured due to the ease of using a plasterboard. After all, plasterboards are solid and available in sheet form in standard sizes of around 2.4 x 1.2 meters. Plasterers Melbourne found it a breeze to handle and put plaster on. What is more, dry lining is a complete dry procedure which allow plasterers to quickly fix any mishaps. Paint can easily be applied to any surface to ensure a warm and welcoming finish.
- The biggest reason why most builders or plasterers prefer using dry lining is due to the speed of applying it and the load being reduced on structures of any kind. As plasterboard walls are lightweight, they offer better flexibility when it comes to planning interior or exterior spaces on the drawing board. In addition, dry lining is a plastering technique that saves you money and time. Yet another reason why it is the most preferred plastering method as far a construction work in timber frames are concerned.

Wet Plastering

- Known to be the most common of all plastering techniques used is wet plastering. It enables experienced plasterers Melbourne to obtain a clean and smooth finish by covering any surface in need of plastering with mortar, then smoothening it using trowels. Dried wet plastered surfaces can be painted or papered according to individual preferences. Like most plastering techniques, it requires skilled plasterers and enough drying time. Wet plastering is prone to shrinkage, cracks, and often times in need of re-plastering in order to cover any cracks.

Defects in Plastering

The following defects may arise in plaster work.

1. **Blistering of plastered surface:** This is the formation of small patches of plaster swelling out beyond the plastered surface, arising out of late slaking of lime particles in the plaster.
2. **Cracking:** Cracking consists of formation of cracks or fissures in the plaster work resulting from the following reasons.
 - i. Imperfect preparation of background
 - ii. Structural defects in building
 - iii. Discontinuity of surface
 - iv. Movements in the background due to its thermal expansion or rapid drying
 - v. Movements in the plaster surface itself, either due to expansion or shrinkage.
 - vi. Excessive shrinkage due to application of thick coat
 - vii. Faulty workmanship.
3. **Efflorescence:** It is the whitish crystalline substance which appears on the surface due to presence of salts in plaster making materials as well as building materials like bricks, sand, cement etc and even water. This gives a very bad appearance. It affects the adhesion of paint with wall surface. Efflorescence can be removed to some extent by dry brushing and washing the surface repeatedly.
4. **Flaking:** It is the formation of very loose mass of plastered surface, due to poor bond between successive coats.
5. **Peeling:** It is the complete dislocation of some portion of plastered surface, resulting in the formation of a patch. This also results from imperfect bond.

6. **Popping:** It is the formation of conical hole in the plastered surface due to presence of some particles which expand on setting
7. **Rust Stains:** These are sometimes formed when plaster is applied on metal laths
8. **Uneven surface:** This is obtained purely due to poor workman ship.

Remedies for minimizing defects plastering work:

- The brickwork and plastering should be carried out in the best workmanship manner.
- The bond of brickwork should be maintained properly.
- The efflorescence is removed by rubbing brushes on damaged surfaces. A solution of one part of HCl or H₂SO₄, and five parts of clean water is prepared and it is applied with the help of brushes on affected area. The surface is washed and cleaned with water.
- The bricks of superior nature should only be used for the brick work.
- The water free from salts should be used for brick work and plastering work
- The surface to be plastered should be well watered so that it may not absorb water from plaster.
- The damp- proof courses should be provided at convenient places in buildings.
- The overall construction should be such that the penetration of moisture is prevented.
- The fresh plastered surface should be protected from surplus quantity of water such as rain and excessive heat such as sun.

9. DAMP PREVENTION

Damp prevention is a chief requirement to ensure safety of building against dampness.

One of the basic requirements in all the buildings is that structure should be dry as far as possible.

If this is not satisfied it is likely that building may become inhabitable and unsafe from structural point of view.

In order to prevent entry of damp into a building the courses known as damp proofing courses are provided at various levels of entry of damp into a building.

Presently all buildings are given dpc treatment

So dpc prevent entry of moisture from walls floors and basements of a buildings

The treatment given to roofs of buildings for some cause is called water proofing.

Cause Of Dampness

Responsible causes are one or more of the followings

1. Faulty design of structure
2. Faulty construction / poor workmanship
3. Use of poor quality of material in construction

These causes give rise to an easy access to moisture to the building from different points, such as rain penetration through walls, roofs and floors etc. The moisture entering into the buildings from foundation and roofs travels in different directions further under the effect of capillary action and gravity respectively. The entry of water and its movement in different parts of the buildings are positively due to one or more of the causes listed above

(1) Rising Of Moisture From The Ground

The subsoil or ground on which the building is constructed may be made of soils which easily give an access to water to create dampness in building. Generally the foundation dampness is caused when the building structures are constructed on low lying water logged areas where a sub soil of clay or peat is commonly found through which dampness will easily rise under capillary action unless properly treated.

This dampness further finds its way to the floors, walls etc. through the plinth.

(2) Action Of Rain Water

Whenever the faces of walls are not suitably protected from the exposure to heavy shower of rains, they become the sources of dampness in a structure. Similarly the poor mortar joints in walls and cracked roofs also allow dampness to enter the building structure. Sometimes due to faulty eave courses and eave gutters, the rain water may percolate through the roof coverings

(3) Rain Penetration From Top Of The Wall

All parapet walls and compound walls of the buildings which have not been protected from rain penetration by using dam proof courses or by such measures on their exposed tops are subjected to dampness. This dampness in the buildings is of serious nature and may result in unhealthy living condition or even in structurally unsafe conditions.

(4) Condensation Due To Atmospheric Moisture

Whenever the warm air in the atmosphere is cooled it gives rise to process of condensation. On account of condensation the moisture is deposited on the whole area of walls, floors, and ceilings. However the sources of dampness is prevalent only in certain places in India, where very cold climate exist.

(5) Miscellaneous Sources Or Causes

The various other sources responsible for dampness in buildings are mentioned below:-

(a) *Poor Drainage Of Site*

The structure if located on low lying site causes water logged conditions where impervious soil is present underneath the foundation.

So such structures which are not well drained cause dampness in buildings through the foundations.

(b) *Imperfect Orientation*

Whenever the orientation of the buildings is not proper or geographical conditions are such that the walls of buildings get less of direct sunrays and more of heavy showers of rains, then such walls become prone to dampness.

(c) *Constructional Dampness*

If more water has been introduced during construction or due to poor workmanship, the walls are observed to remain in damp condition for sufficient time.

(d) *Dampness Due To Defective Construction*

Dampness in buildings is also caused due to poor workmanship or methods of construction viz inadequate roof slopes, defective rain water pipe connection, defective joints in roofs in proper connection of walls etc.

Effect Of Dampness

The various effects (indirectly defects), caused due to dampness in buildings are mentioned below

All effects mainly result in poor functional performance, ugly appearance and structural weakness of the buildings.

- (a) A damp building creates unhealthy living and working conditions for occupants.
- (b) Presence of damp conditions causes efflorescence on building surface, which ultimately may result in the dis-integration of bricks, stones, tiles etc. and hence in the reduction of strength.
- (c) It may cause bleaching and flaking of the paint which results in the formation of coloured patches on the wall surfaces and ceilings.
- (d) It may result in corrosion of metals used in the construction of buildings.
- (e) The material used as floor coverings, such as tiles, are damaged because they lose adhesion with the floor base.
- (f) Timber, when in contact with damp conditions, gets deteriorated due to the effects of warping, buckling and rolling of timber.
- (g) All electrical fittings get deteriorated, causing leakage of electric current with the potential danger of a short circuit.
- (h) Dampness promotes the growth of termites and hence creates unhygienic conditions in buildings.
- (i) Dampness when accompanied by the warmth and darkness, breeds the germs of tuberculosis, neuralgia, acute and chronic rheumatism etc. which sometimes result in fatal diseases.

Techniques And Methods Of Damp Prevention

The following precautions should be taken to prevent the dampness in buildings, before applying the various techniques and methods described later :

- (I) The site should be located on a high ground and well drained soil to safeguard against foundation dampness. It should be ensured that the water level is at least 3m. below the surface of ground or lowest point even in the wet season. For better drainage the ground surface surrounding th building should also slope away.
- (II) All the exposed walls should be of sufficient thickness to safe guard against rain penetration. If walls are of bricks they should be at least 30 cm thickness
- (III) Bricks of superior quality which are free from defects such as cracks, flaws, lump of lime stones should be used. They should not absorb water more than 1/8 of their own weight when soaked in water for 24 hours.
- (IV) Good quality cement mortars should be used to produce a definite pattern and perfect bond in building units throughout the construction work. This is essential to prevent the formation cavities and occurrence of differential settlement.
- (V) Cornices and string courses should be provided. Window sills, coping of plinth and string courses should be slopped on top and throated on the undesirable to throw the rain water away from walls.
- (VI) All the exposed surfaces should be covered with waterproofing cement plaster
- (VII) Hollow walls are more reliable than solid walls in preventing dampness and hence the cavity wall construction should be adopted wherever possible.

Prevention of dampness

Use of damp proofing courses or membranes-

These are the layers or membranes of water repellent material such as bituminous felts, mastic asphalts, plastic sheets, cement concrete, mortar, metal sheets which are interposed in the building structure at all location wherever water entry is anticipated. These damp proof courses of suitable materials should be provided at appropriate location for their effective use. Basically D.P.C is provided to prevent the water rising from the sub soil and getting into the different part of the buildings. The best location for D.P.C in case of buildings without basement lies at the plinth level or in case of structure without plinth should be laid at least 15 cm above the ground. These damp proof courses may be provide horizontally or vertically in floors, walls etc. in case of basement laying of D.P.C is known as tanking.

While providing damp-proof courses in buildings, the following general principles should be observed in practice.

- The DPC should cover the full thickness of the walls excluding rendering, in order to act as an effective barrier to moisture under all conditions.
- The mortar bed upon which the DPC is laid should be level, even and free from any projections.
- The DPC course should be placed in correct relation with other DPC courses so as to provide a complete course should be placed in correct relation with other DPC courses so as to provide a complete and continuous barrier to the passage of moisture from below, top or sides. Therefore, the junctions and corners, formed by walls, or walls and floors, should be laid continuous.
- Where a vertical DPC is to be laid continuous with a horizontal DPC(i.e., forming angle projection), a fillet 75mm in radius should be provided. the DPC should not be exposed on the wall surface, otherwise it is likely to be damaged by carpenters, tile layers, etc.

(2) Waterproof (or damp proof) surface treatment

The surface treatment consists in filling of the pores of the material exposed to moisture by providing a thin film of water repellent material over the surface. These surface treatments can be either external or internal, the external treatment is effective in preventing dampness where as internal one only reduces it to a certain extent.

Many surface treatments like pointing, plastering. Painting, distempering, are given to the exposed surfaces and also to the internal surfaces. Most commonly used treatments, to protect the walls against dampness, is lime cement plaster of mix (one cement : one lime : six sand) proportions. A thin film of water proofing can be materials, generally employed as waterproofing agent in surface treatments are : sodium or potassium silicates, aluminium or zinc sulphates, barium hydroxide and magnesium sulphate in alternate applications, soft soap and alum also in alternate applications, lime and linseed oil, coal tar, bitumen, waxes and fats, resins, and gum, etc.

Some of the above mentioned materials, like the waxes and fats, are unsuitable in the tropics as they melt with rise in temperature, resins and gums and also not lasting materials are coal tar and bitumen disfigure the original surface.

(3) Integral damp-proofing treatment

The integral treatment consists adding certain compounds to the concrete or mortar during the process of mixing, which when used in construction act as barriers to moisture penetration under different principles. Compounds like chalk, talc, fuller's earth, etc. have mechanical action principle, i.e., they fill the pores present in the concrete or mortar and make them denser and water proof. The compounds, like alkaline, silicates, aluminium sulphates, calcium chlorides, etc. work on chemical action principle i.e., they react chemically and fill in the pores to act as water resistant. Similarly, some compounds like soaps, petroleum oils, fatty acid compounds such as stearates of calcium, sodium ammonium

etc.work on repulsion principle i.e., they are used as admixtures in concrete to react with it and become water repellent.

The synthetic compound prepared under this principles are available in commercial forms, like Pudlo, Sika, Novoid, Ironite, Dampro, Permo Rainers,etc.

(4) cavity walls

❖ A cavity wall consist of two parallel walls/leaves/skins of masonry, separated by a continuous air space/cavity.

❖ They consists of three parts.

- Out wall/leaf(exterior wall part 10cm thick)
- Cavity/air space(5cm-8cm)
- Inner wall/leaf(minimum 10cm thick)

❖ The two leaves forming a cavity in between may be of equal thickness or may not be. The inner wall thickness may more to take larger properties of imposed loads transmitted by floor and roof.

❖ Provision of continuous cavity in the wall efficiently prevents the transmission of dampness from outer to inner wall.

❖ Under climatic conditions of India (hot-dry/hot-humid), cavity type construction is most desirable as it offers many advantages such as better living and comfort conditions, economic construction and preservation of buildings against dampness.

1. As there is no contact between outer and inner walls of a cavity wall except at wall ties, which are of impervious material, so possibility of moisture penetration is reduced to a minimum.

2. It has been verified a cavity wall of 10cm thick internal and external walls with 5cm cavity/air space in between is better or more reliable than solid wall of 20cm thickness w.r.t damp prevention.

3. The cavity wall offers good insulation against sound.

4. It reduces the nuisance of efflorescence.

5. It offers other advantages like,

- Economy
- Better comfort

- Hygienic conditions in buildings.
-

(5) Shot concrete(guniting)

This consists in forming an impervious layer of rich cement mortar(1:3) for water proofing over the exposed concrete surface or over the pipes, cisterns, etc. for resisting water pressure. Guniting is a mixture of cement and sand on well graded fine aggregate, the usual proportion being 1:3 or 1:4. A machine known as cement gun, having a nozzle for spraying the mixture and a drum of compressed air for forcing the mixture under desired pressure, is used for this purpose. Any surface which is to be treated is first thoroughly cleaned of any dirt, grease or loose particles and then fully wetted. The mix of cement and sand is then shot under a pressure of 2-3kg/sq.cm by holding the nozzle of cement gun at a distance of 75-99 cm from wall surface. The necessary quantity of water is added by means of regulating valve soon after the mixture comes out from cement gun. So mix of desired consistency and thickness can be sprayed, to get an impervious layer, the impervious surface should be watered for about 10 days.

By this technique impervious layer of high compressive strength can be obtained (28 days strength) and so it is useful method for reconditioning/repairing old concrete works, bricks and masonry works, which have deteriorated.

(6) Pressure grouts (cementation)

Cementation is the process of forcing the cement grout (mix of cement, sand, water) under pressure into cracks, voids, fissures present in structural components/ground. All the components of a structure in general and foundation, which are liable to moisture penetration are consolidated and so made water resistant by this process.

Here holes are drilled at selected points in structure and cement grout of sufficiently thin consistency is forced under pressure to ensure complete penetration onto cracks. This makes structure water tight and restores stability and strength.

When structure is resting on hard but loose textured ground its strength can be increased, by this process. This technique is used for repairing structures, consolidator ground to improve bearing capacity forming water cut offs to prevent seepage.

10. DOORS AND WINDOWS

TYPES OF WINDOWS

Depending upon the manner of fixing, materials used for construction, nature of the operational movements of shutters, etc., the common varieties of windows used in the building can be grouped as follows:

1. Casement windows
2. Sliding windows
3. Metal windows
4. Corner windows
5. Gable windows bay windows
6. Lantern or lantern lights
7. Skylights

CASEMENT WINDOWS:

These are the windows, the shutters of which open like doors. The construction of a casement window is similar to the door construction.

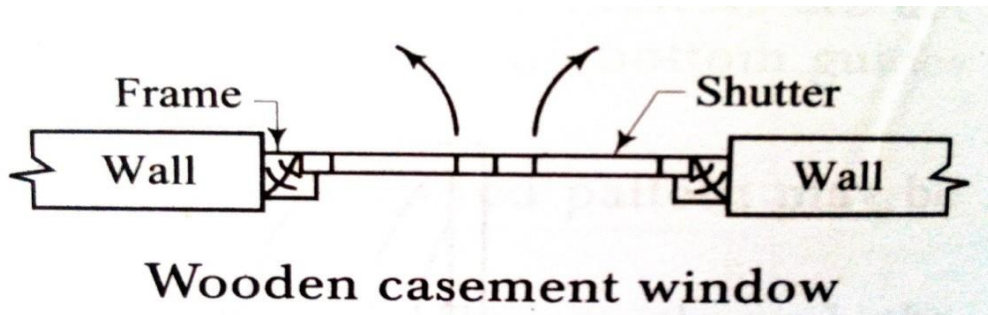

SLIDING WINDOWS:

These windows are similar to the sliding doors and the shutters moves on the roller bearings, either horizontally or vertically. Such windows are provided in trains, buses, bank counter, shops etc.

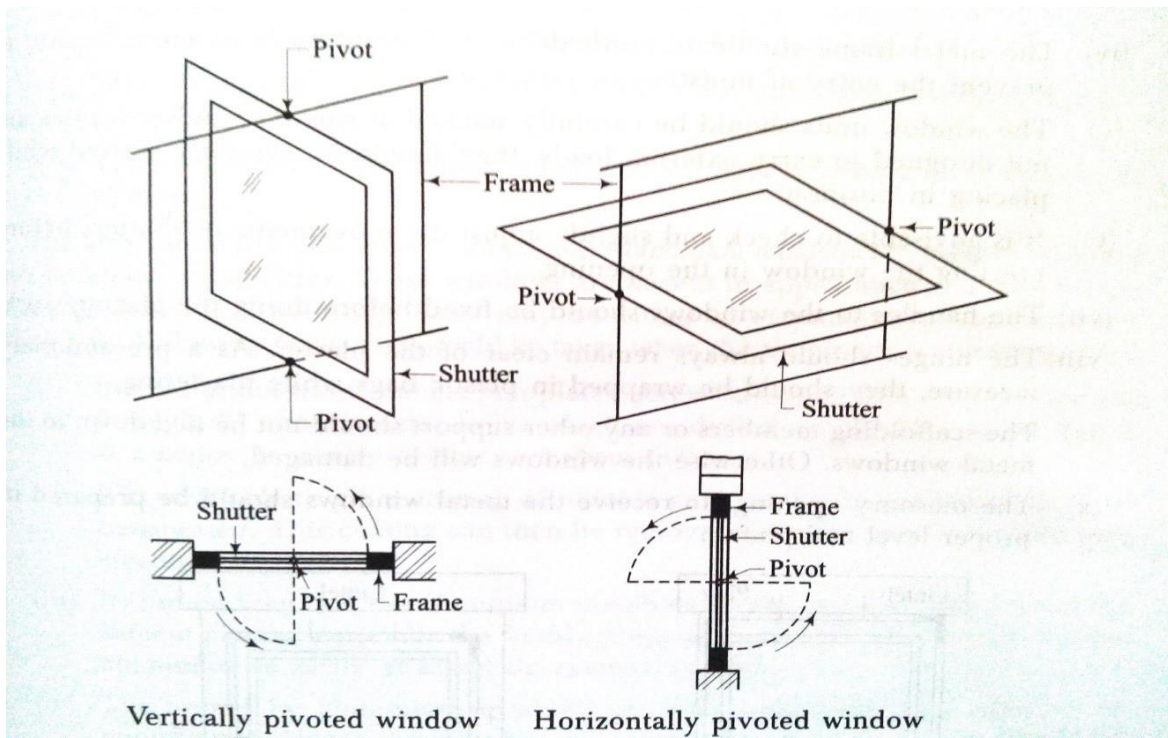

METAL WINDOWS:

These are now a days widely used, especially for public building. The metal used in construction may be mild steel, bronze, or other alloys. The metal frame may be fixed direct to the wall or it may be fixed on a wooden frame.

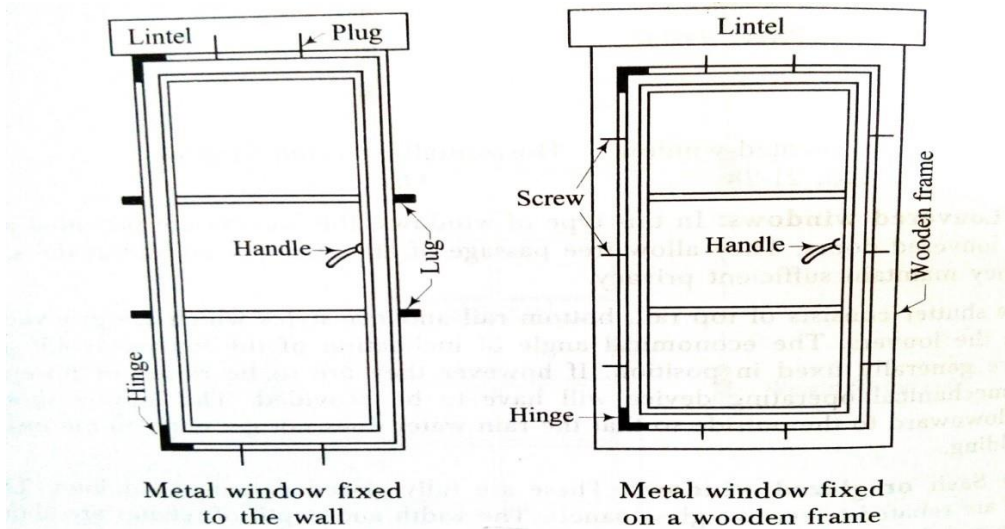

CORNER WINDOWS:

These windows are provided at the corner of a room .They are placed at the corner of the room and thus they have two faces in two perpendicular direction. Due to such situation,there is entry of light and air from two direction and in many cases , the elevation of building is also improved.

GABLE WINDOWS:

These are the windows which are provided in the gable ends of a roof.

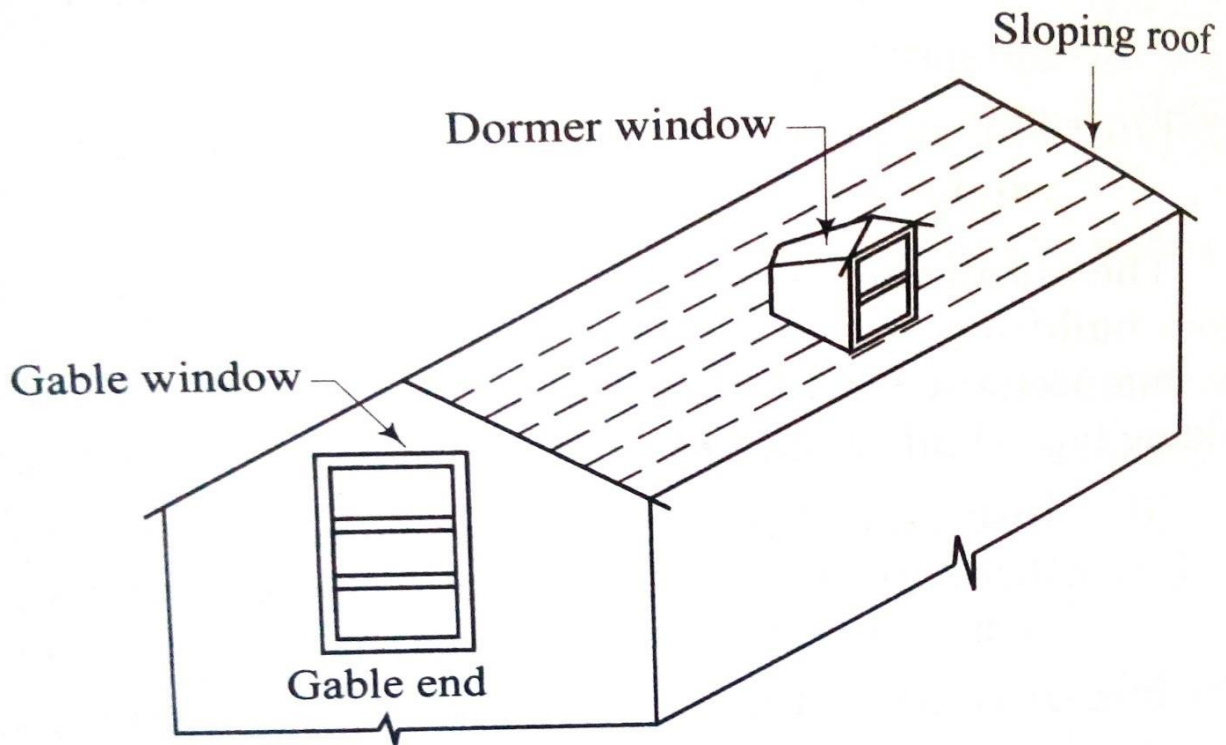

Gable window and dormer window

BAY WINDOWS:

These windows project outside the external wall of a room. They maybe square , splayed, circular, polygonal or of any shape. The projection of bay windows may start from floor level or sill level. These windows admit more lights, increase opening area , provide ventilation and improve the appearance of building.

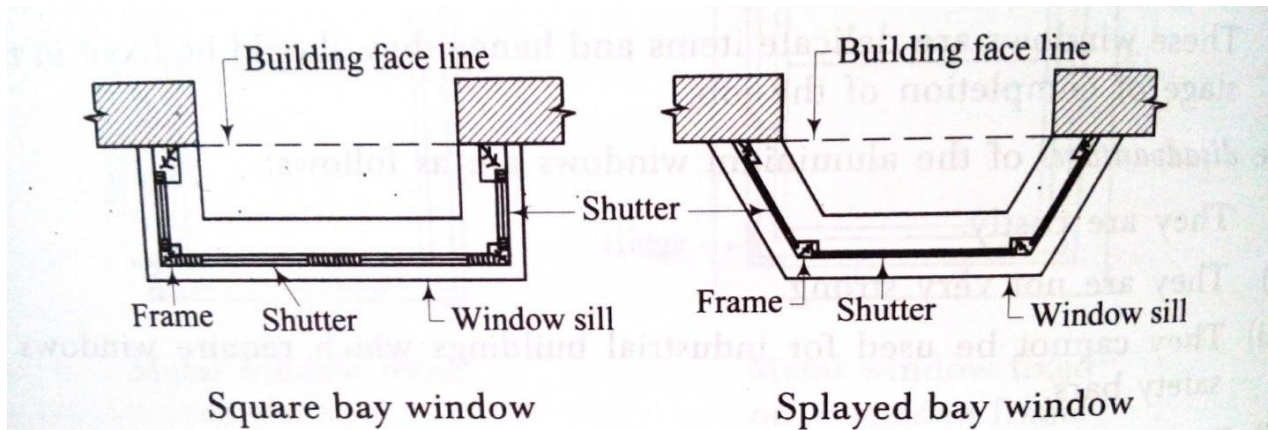

LANTERNS:

These are the windows which are fixed on flat roofs to provide light to the inner portion of building where light coming from external windows are insufficient. They may be square or rectangular or curved.

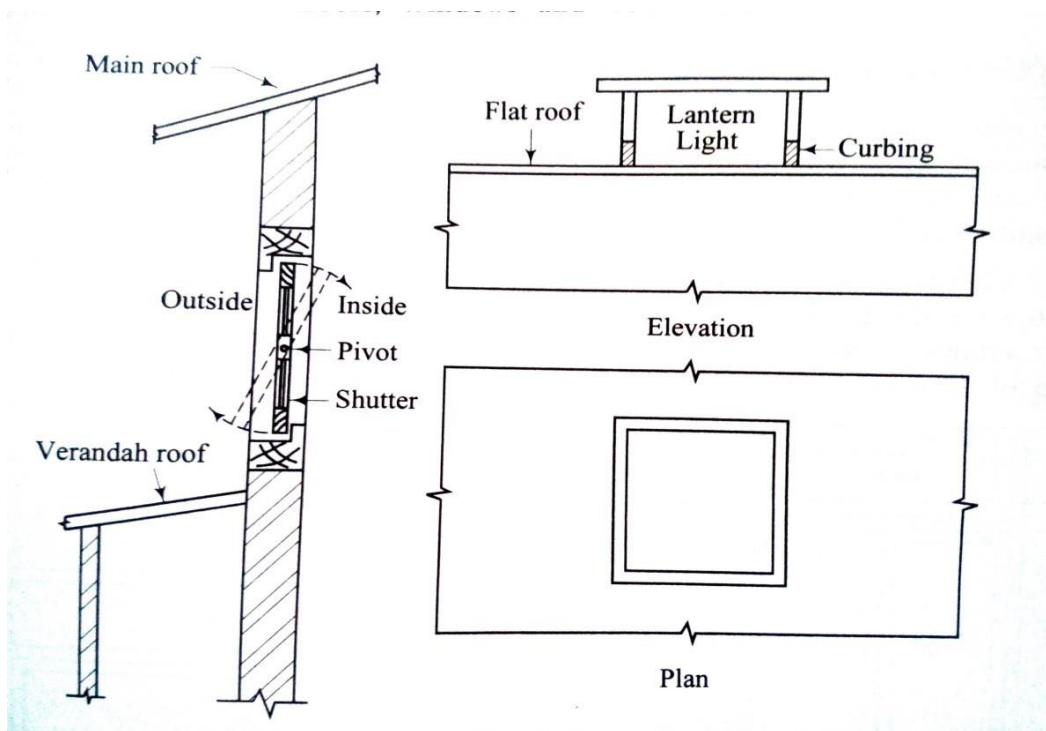

SKYLIGHTS:

these are the windows which are provided on the sloping surface of a pitched roof. The common rafter are suitably trimmed and the skylight is erected on a curb frame. As skylight are mainly meant for light, they are usually provided with the fixed glass panel.

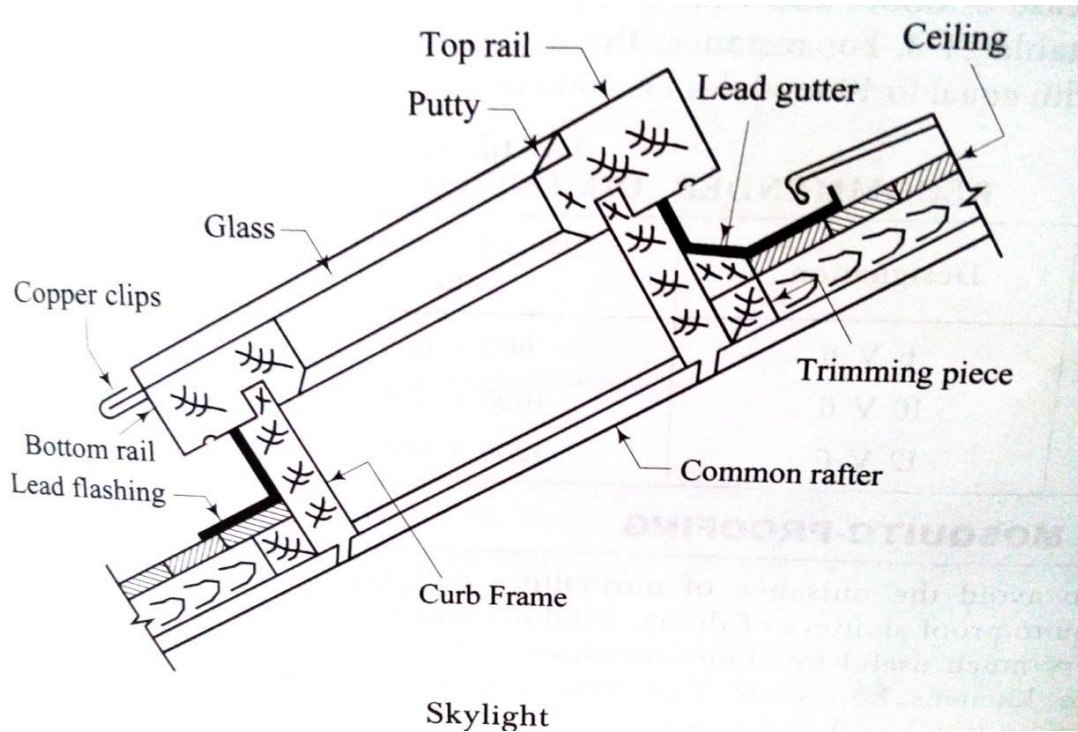

TYPES OF DOORS

A **door** is a moving structure used to block off, and allow access to, an entrance to or within an enclosed space, such as a building or vehicle. Similar exterior structures are called gate. Typically doors have an interior side that faces the inside of a space and an exterior side that faces the outside of that space. While in some cases the interior side of a door may match its exterior side, in other cases there are sharp contrasts between the two sides, such as in the case of the vehicle door. Doors normally consist of a panel that swings on hinges or that slides or spins inside of a space.

Panel doors:

Panel doors, also called stile and rail doors, are built with frame and panel construction. EN 12519 is describing the terms which are officially used in European Member States. The main parts are listed below:

- Stiles - Vertical boards that run the full height of a door and compose its right and left edges. The hinges are mounted to the fixed side (known as the "hanging stile"), and the handle, lock, bolt, and/or latch are mounted on the swinging side (known as the "latch stile").

- Rails- Horizontal boards at the top, bottom, and optionally in the middle of a door that join the two stiles and split the door into two or more rows of panels. The "top rail" and "bottom rail" are named for their positions. The bottom rail is also known as "kick rail". A middle rail at the height of the bolt is known as the "lock rail", other middle rails are commonly known as "cross rails".
- Mullions - Smaller optional vertical boards that run between two rails, and split the door into two or more columns of panels, the term is used sometimes for verticals in doors, but more often (UK and Australia) it refers to verticals in windows.
- Muntin - Optional vertical members that divide the door into smaller panels.
- Panels - Large, wider boards used to fill the space between the stiles, rails, and mullions. The panels typically fit into grooves in the other pieces, and help to keep the door rigid. Panels may be flat, or in raised panel designs. Can be glued in or stay as a floating panel.
- Light or Lite - a piece of glass used in place of a panel, essentially giving the door a window.

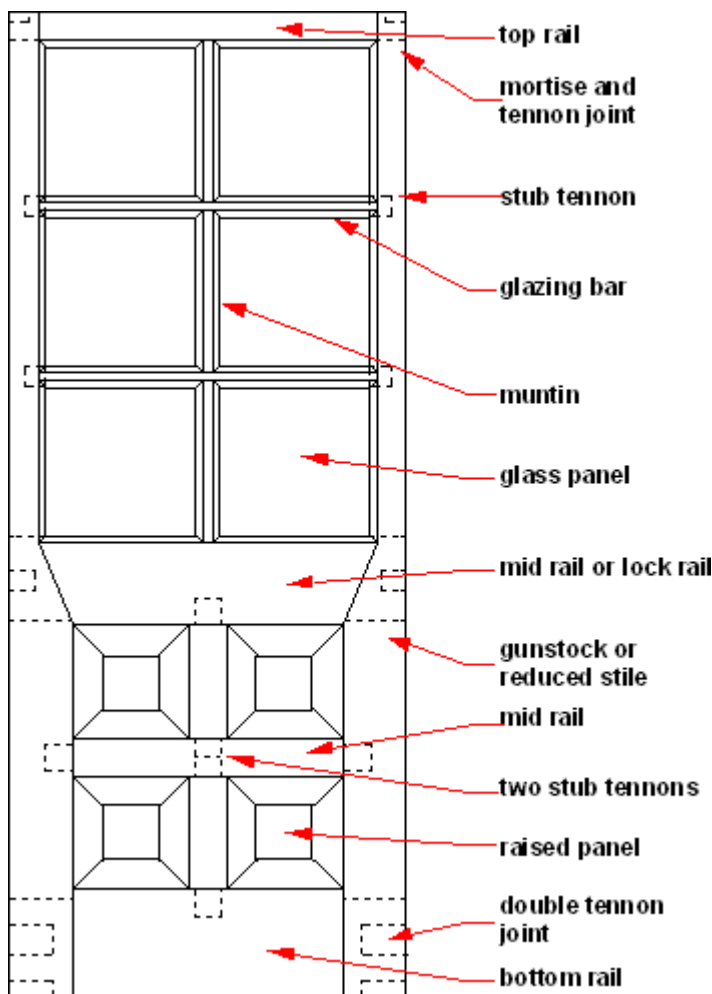

Plank and batten doors:

Plank and batten doors are an older design consisting primarily of vertical slats:

- Planks - Vertical boards that extend the full height of the door, and are placed side by side filling the door's width.
- Battens - Smaller slats that extend horizontally across the door which the planks are affixed to. The battens hold the planks together. Sometimes a long diagonal slat or two are also implemented to prevent the door from skewing. On some doors, especially antique ones, the battens are replaced with iron bars that are often built into the hinges as extensions of the door-side plates.

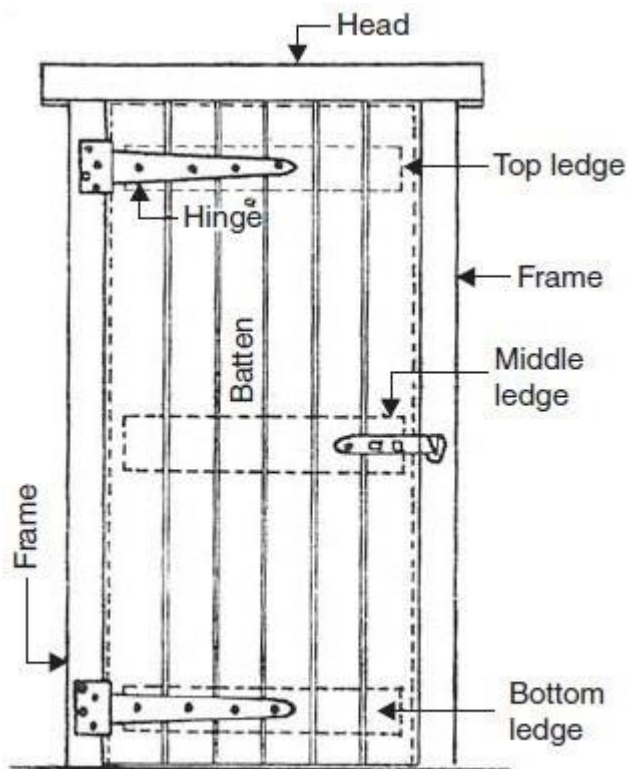
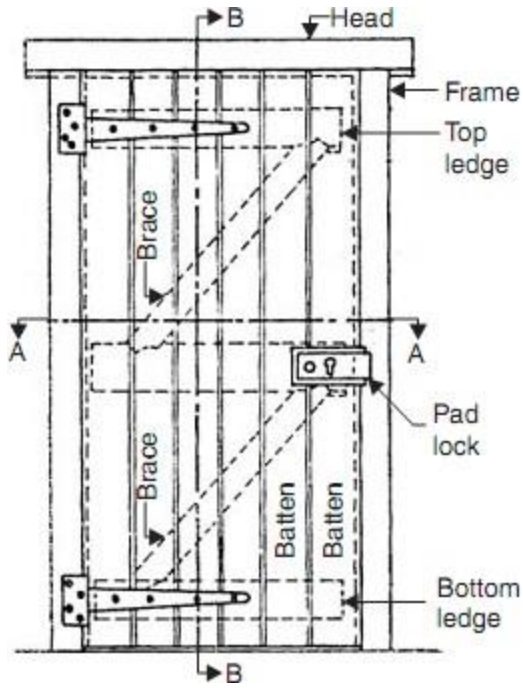

Fig. 8.21. Batted and ledged door

Ledged and braced doors:

This type consists of vertical tongue and grooved boards held together with battens and diagonal braces.



Frame and filled doors:

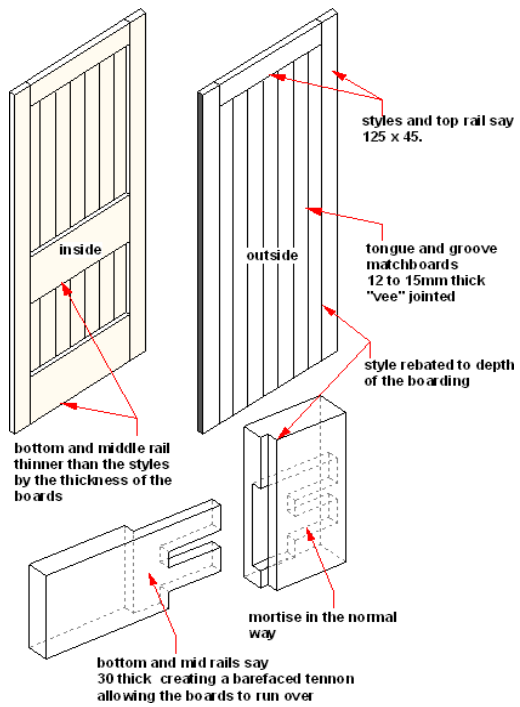

This type consists of a solid timber frame, filled on one face, face with Tongue and Grooved boards. Quite often used externally with the boards on the weather face.

Flush doors:

A flush door consists of a framework of rails and styles and it is covered with plywood. There are two varieties of flush doors

1. framed flush door :

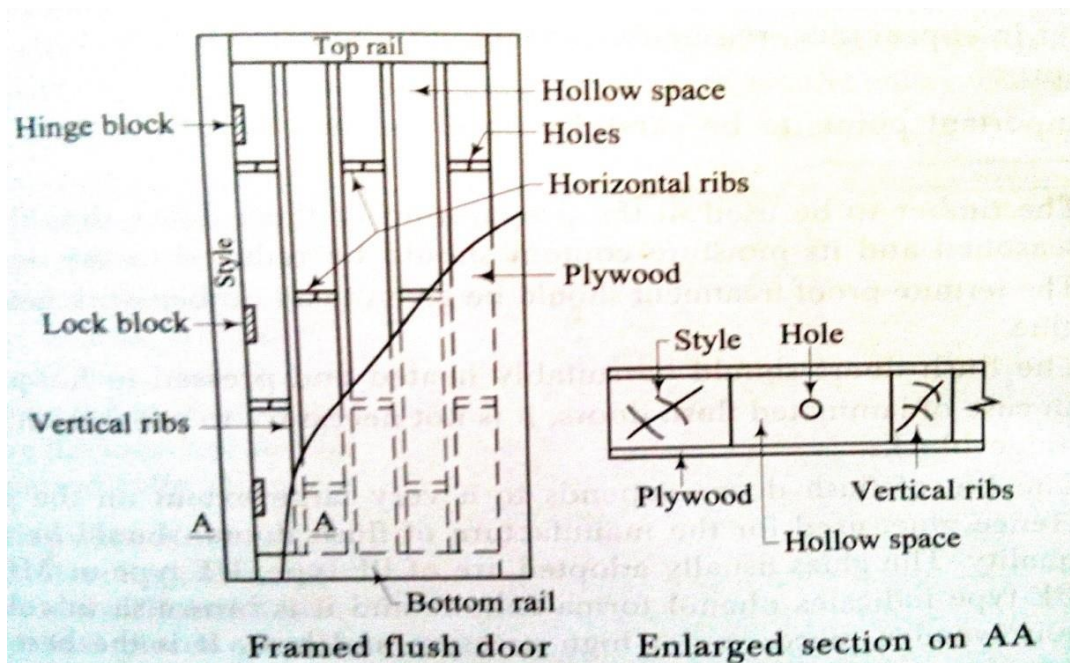

It consists of styles, rails, horizontal ribs, vertical ribs, and plywood. As shown in fig.

2. laminated flush door

It consists of styles, rails, laminated core and plywood as shown in fig.

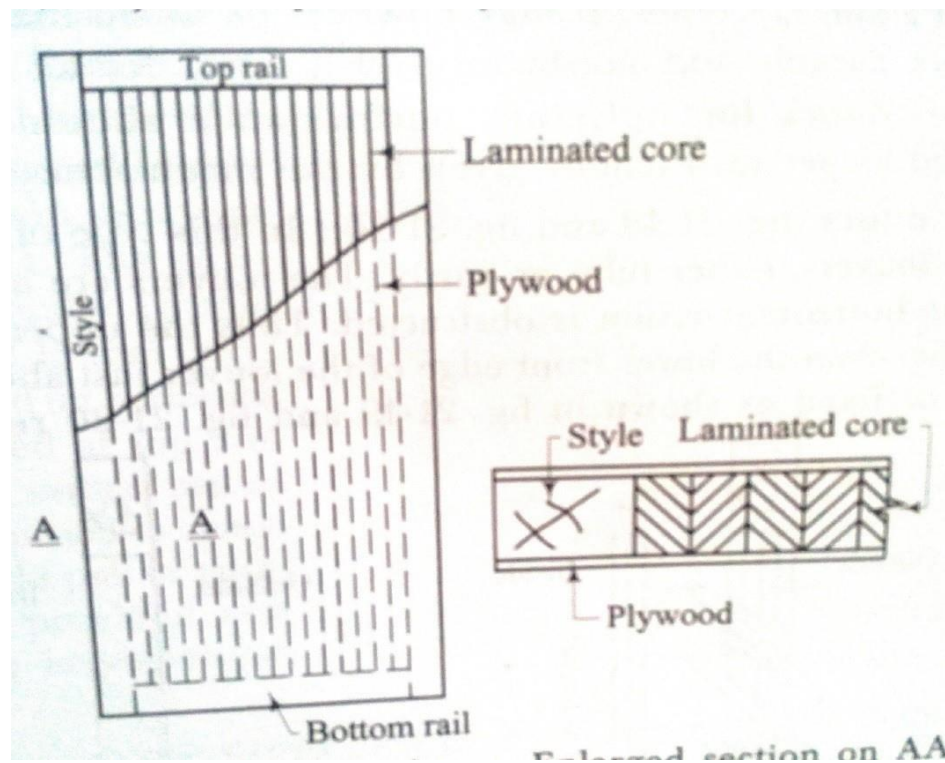

Louvered Doors:

In this type of doors, the shutters are provided with louvers, either fully or partly. The louvers are arranged at such an inclination that horizontal vision is obstructed. The louvers may be movable or fixed as shown in fig.

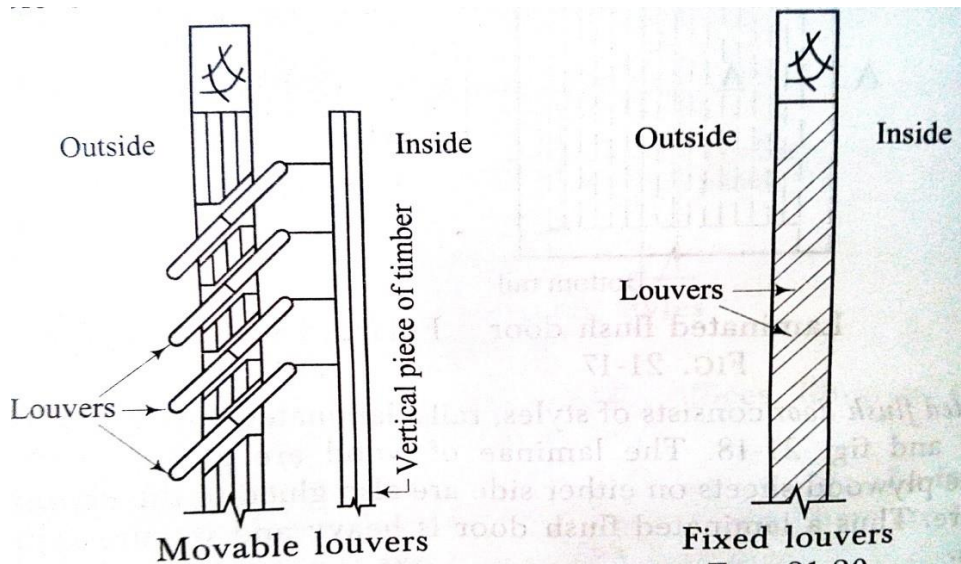

Collapsible Steel Doors:

It consists of a mild steel frame. A collapsible steel door works without hinges and it is used for compound gates, residential building , schools, sheds, godowns , workshop, public building , etc.

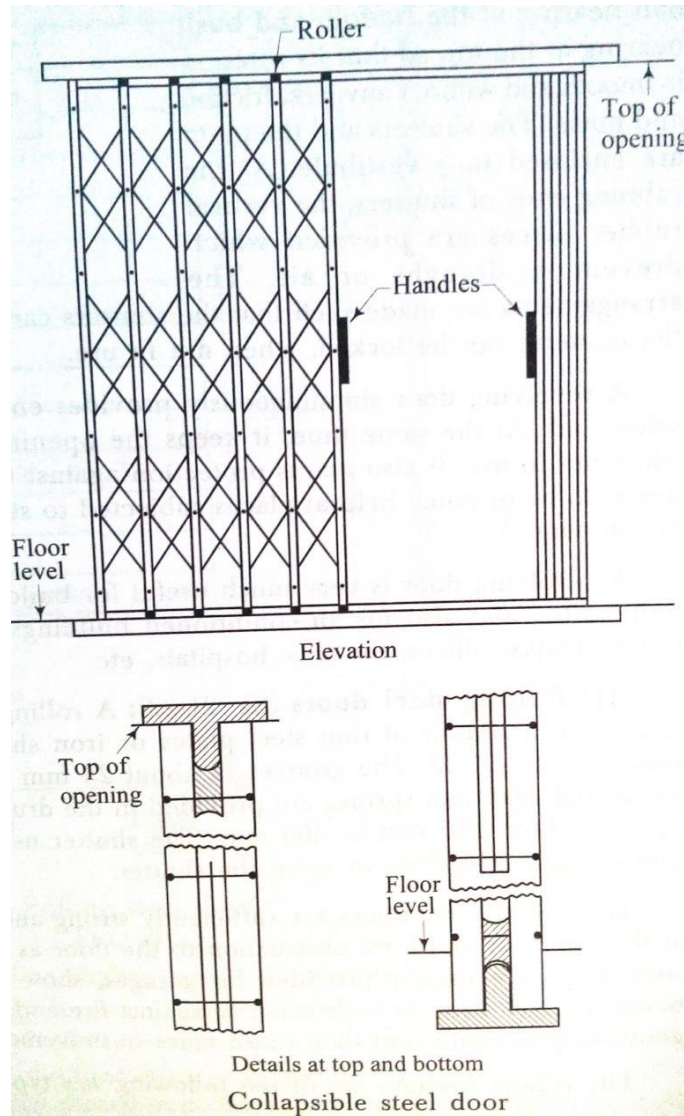

Revolving Doors:

It essentially consists of a centrally placed mullion in a circular opening revolving shutters which are 4 in number are radially attached to pivot as shown in fig.

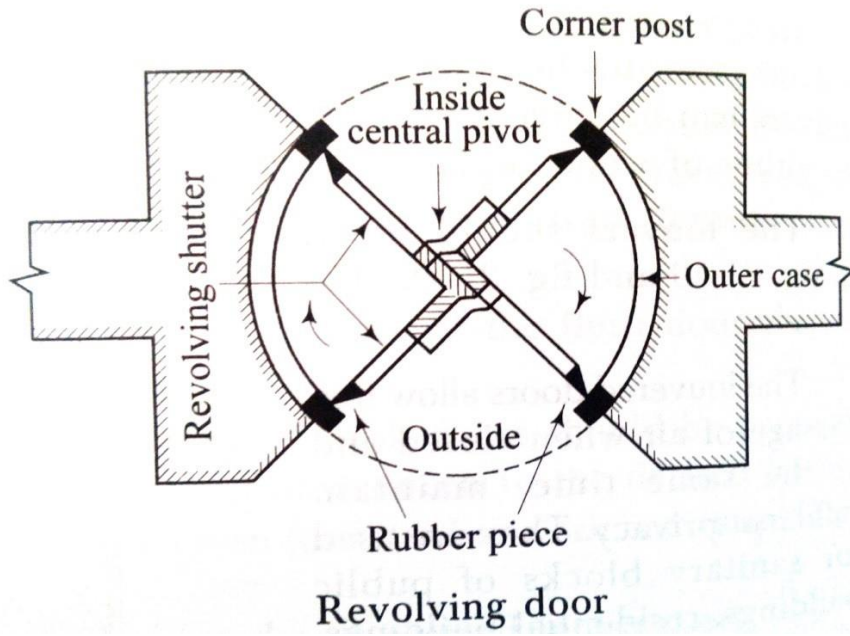

11. PAINTING

Paint is a liquid surface coating. On drying it forms a thin film on the painted surface. Paints are classified as oil paints, water paints, cement paints, bituminous paints and special paints such as fire proof paints, luminous paints, chlorinated rubber paints (for protecting objects against acid fumes), etc. The paintings are the coating of fluid materials

The functions of the paints are:

- To protect the coated surface against possible stresses mechanical or chemical; deterioration—physical or environmental;
- Decorate the structure by giving smooth and colourful finish; check penetration of water through R.C.C;
- check the formation of bacteria and fungus, which are unhygienic and give ugly look to the walls;
- check the corrosion of the metal structures;
- Check the decay of woodwork and to varnish the surface to display it to better advantage

Defects in Painting:

- A painted building with full colour effects gives complete satisfaction. But the appearance of defects becomes a ready source of complaint. Unfortunately painting defects are by no means uncommon. They may arise from a variety of causes but the principal reasons behind them are incorrect choice of paint in relation to backing materials, application of paint to a damp surface or one to which moisture may have access and; poor workmanship.

Effects of background:

- The factors affecting durability are dampness, cleanliness, movements, chemical reactions, etc. The traditional construction in brick, cement, etc. involves the use of wet procedures. If paint is applied on an insufficiently dry background the moisture is trapped and in the process of subsequent drying the adhesion of the paint breaks down. Emulsion paints are somewhat better in this respect.

- The painting processes can be delayed for proper results for movements caused by shrinkage and special paints should be used for thermal movements.
- Chemical reaction between backing material and paint film may push the paint off the backing material and lead to softening or decolourise the paint. This effect generally occurs only if moisture is present and is noticeable in oil paints over materials containing cement or lime. The breakdown of bond is because of the crystallization of salts below the paint film and the discolouration is usually due to action of free lime on the pigments.

Effects of weather:

The paint film is subjected to chemical attack of atmosphere, sunlight and heat, all deteriorating it. Special chemical resistant paints should be applied in industrial areas. Alkali resistant paints weather well in coastal areas. Blue and green colours tend to fade when exposed to bright light. In addition the fierce heat of sun may breakdown the paint film because of the disintegration of the material itself and also because of the thermal movement. The most common defects noticed after paintings are as follow:

Blistering and peeling are swelling of the paint film and can be defined as localized loss of adhesion between one or more coatings or between primer and parent surface. When swelling is because of oil or grease on the surface it is known as blistering and in case of moisture it is called peeling. It occurs in nonporous coatings such as oil based paints and enamels. A special heat-resisting type of paint should be used for hot surfaces such as radiators. It is brought about by moist air, oily or greasy surface, or imprisoned gases between the painted surface and the paint film, which expand under the influence of heat. Emulsion paints provide a porous coating and allow the moisture to pass through.

Checking is a mild form of cracking. If hair cracks produced enclose small area it is known as crazing. In case the enclosed area is large the defects is called crocodiling. It is caused when the paint film lacks in tensile strength and occurs when paint is applied during very cold weather or because of insufficient drying of undercoat. When cracks are very small and do not enlarge with time, the top coating is flattened with emery paper and a fresh coat of paint is applied.

Cracking: The cracks extend throughout the entire paint system extending right down to the original surface. Cracks in the plaster or masonry do not let the paint to remain intact.

Paint applied on glossy surface. Premature application of top coat before the previous coat has completely dried. Painting improperly seasoned wood.

Flaking: It is detachment of paint film from the surface. The moisture penetrates through the cracks on the coatings and the bond between surface and paint film is lost. The curing methods are: Use of plastic emulsion paints, Surface should be rubbed with emery paper before applying a fresh coat and All dirt or dust on surface should be removed prior to painting.

Chalking: Paint film becomes powder due to insufficient oil in primer.

Alligatoring: One layer of paint films sliding over the other one, when a hard paint is applied over a soft one or vice versa.

Wrinkling: or crawling appears when the paint film is quite thick or the oil in the paint is more than required. The lower portion of the paint does not dry due to greater thickness of the paint film which shrinks due to drying in course of time.

Running and sagging: Paints applied over smooth and glossy surface do not stick and flow back or towards the unpainted area. This is known as running and sagging. The surface to-be painted should, therefore, be rubbed with an emery paper before painting.

Bloom: is identified as dull patches on the finished, polished or painted surface due to defect in the quality of paint or poor ventilation.

Flashing: is characterized by the appearance of certain glossy patches on the painted surface. The reasons attributed to this defect are weathering actions, use of cheap paint, and poor workmanship.

Grinning: it is due to the imperfect opacity of the paint film even after the final coat. The background and its defects can be clearly visible in such a case.

Failure of Painting: The main causes of failure of painting are:

• Bad workmanship	• Conditions for painting
• Moisture	• Salt and alkalies
• Unsuitable surfaces	• Wrong choice of paint

Painting of various surfaces:

A. New plastered surface:

The procedures for painting a new plastered surface are:

- 1. Surface preparation:** Paint cannot take care of construction defects. Before applying the paint, it is ensured that the surface is free from dust, dirt, loose matter, grease etc. and is rubbed with an emery paper, to provide a mechanical key between surface and paint for satisfactory adhesion.
- 2. Sequence of Painting:** The primer (first coat) is applied with brush or spray on the prepared surface. It should be thinned with water or thinner in the recommended manner and proportion before application. After drying it is rubbed with emery paper. Dents and cracks, if any, are filled with putty using a knife applicator. Putty should not be applied thick. If the required thickness is large, it should be applied in two coats. After the putty has dried, the whole surface is rubbed down well in order to smoothen the putty and provide a mechanical key to the finished coats. Two or three finish coats are applied. Each coat is allowed to dry before the application of next coat.

B. Old plastered surface

The procedure depends on the state of the existing coating. If any of the defects discussed below is very much pronounced it is completely removed and the surface is painted as a new surface.

C. Painting of new woodwork

Painting of woodwork should be done with great care. Normally 3–4 coats are sufficient for wood work.

- **Surface preparation:** The wood should be well seasoned, dried, cleaned and the surface made smooth with an emery paper. Nails, if any, should be driven down the surface by at least 3 mm.
- **Knotting:** Knots in the wood create lot of problems. These excrete resin which causes defects such as cracking, peeling and brown discolouration. Knotting is done so that resin cannot exude from the knots. Any of the following methods may be used suitably.

Ordinary knotting: This is also known as size knotting. The knot is treated with a coat of hot red lead ground with a strong glue size in water. Then a coat of red lead ground in boiled linseed oil is applied.

Lime knotting: The knot is covered with hot lime for 24 hours after which it is scrapped off. Thereafter, the process described in ordinary knotting is followed.

Patent knotting: Two coats of varnish or shelac are applied.

- **Priming coat:** The main function of priming coat or primer is to form the base for subsequent ones. After knotting priming coat is applied over the entire surface to fill all the pores. A second priming coat is applied after first has dried. In general the ingredients are same as those of the subsequent coats but with a difference in proportion.
- **Stopping:** After the priming coat putty is applied to fill the pores of the surface. Then it is rubbed smooth. Colouring pigment is also added to it to match the shade of the finished coat. On drying, the selected paint is applied with brushes to bring smoothness and uniformity in colour. After painting the surface in one direction, the brush is worked in the perpendicular direction to eliminate brush marks. This is known as crossing. All the successive coats are applied after drying and slight rubbing of previous coats for proper bond.

D. Painting of old woodwork:

The old paint is removed with a sharp glass piece, sand paper, paint remover or with a blow lamp. Any smoky or greasy substance should be washed with lime and subsequently rubbed with pumice stone. The surface is then washed with soap and water and dried completely. Then two coats of paints are applied in a way similar to that described in painting new surfaces.

E. Painting metal surfaces:

- **New ironwork:** The surface should be free from scales, rust and grease. Scales and rust are cleaned by hard wire brush. Grease is removed by using petroleum or by hot alkaline solution of Na_2CO_3 or NaOH , benzene, and lime water. A priming coat of red lead with barytes and raw linseed oil is then applied over the prepared surface. After drying of the priming coat, one or more undercoats with desired paint are applied. The second coat is given only after the first coat has dried. The finishing coat is applied carefully to produce a smooth fine surface.

- Old ironwork: The surface is prepared by scraping properly all the scales and rust with emery paper. The greasy substances are removed with lime water. The old paint may be burned with a blow lamp or by suitable solvents. After this the surface is brushed with hot linseed oil and painted as for new iron work.
 - Structural steel: The major problem to overcome in painting iron and steel is corrosion due to electrolysis caused by the presence of air and moisture. Red lead is considered to be the best priming coat; it produces a tough elastic film, impervious to air and moisture. Pure linseed oil priming coat is detrimental in that it stimulates corrosion. The linseed oil film is rendered more impervious by the use of spar varnish. Graphite paint used for black colour, is very durable and is not affected by sulphur films, ammonia or chlorine gases. Silica-graphite paints are best; they do not crack and blister in course of time. Aluminium paint is also gaining popularity because of its shining and contrast properties and heat and chemical resistance. Bituminous paints may be very well adopted to paint inside of pipes, iron under waters, piles, ships and boats; they are unsatisfactory when exposed to sunlight. Lead or zinc paint should never be applied directly over the iron surface as it encourages galvanic action destroying the paint.
- F. Painting of floor surfaces:** The enamels are used for painting of floor surfaces. The selected enamel should be strong enough to resist abrasion, moisture, and alkali actions. It should be of shining nature and quick drying type.
- G. Painting of concrete surfaces:** The cement paint is used to paint concrete surfaces. The paint is available in a powder form and it is dissolved in water to workable consistency. The paint thus prepared should be consumed within 2 to 3 hours. The two coats are applied at an interval to provide curing of painted surface.

12. GLAZING

TYPES OF GLASS:

- (1) Soda-lime glass
- (2) Potash-lime glass
- (3) Potash-lead glass
- (4) Common glass

(1) Soda-lime glass:

This is also known as soda-glass or soft glass. It is mainly a mixture of sodium silicate and calcium silicate.

Properties:

- (i) It is available in clean and clear state.
- (ii) It is cheap.
- (iii) It is easily fusible at comparatively low temperature.

Uses: It is used in the manufacture of glass tubes and laboratory apparatus, plate glass, window glass, etc.

(2) Potash-lime glass:

Also known as bohemian-glass or hard glass. It is mainly a mixture of potassium silicate and calcium silicate.

Properties:

- (i) it fuses at high temperature.
- (ii) it is not easily affected by water and other solvents.
- (iii) it does not melt so easily.

Uses: used in manufacture of glass articles.

(3) Potash-lead glass:

Also known as flint glass. It is a mixture of potassium silicate and lead silicate.

Properties:

- (i) Fuses very easily.

- (ii) Easily attacked by aqueous solution.
- (iii) Posses great refractive power.
- (iv) Specific gravity is about 3 to 3.50.
- (v) Turns black and opaque.

Uses: used in the manufacture of artificial gems, electric bulbs, lences, prisms etc.

(4) Common glass

Also known as bottle glass. Manufacture of sodium silicate, calcium silicate and iron silicate.

Properties:

- (i) Fuses with difficulty.
- (ii) It is brown, grey or yellow in colour.
- (iii) easily attacked by acids.

Uses: it is mainly used for medicine bottles.

MANUFACTURING OF GLASS:

1. Batch processing system (batch house):

Batch processing is one of the initial steps of the glass-making process. The batch house simply houses the raw materials in large silos (fed by truck or railcar) and holds anywhere from 1–5 days of material. Some batch systems include material processing such as raw material screening/sieve, drying, or pre-heating (i.e. cullet). Whether automated or manual, the batch house measures, assembles, mixes, and delivers the glass raw material recipe (batch) via an array of chutes, conveyors, and scales to the furnace. The batch enters the furnace at the 'dog house' or 'batch charger'. Different glass types, colors, desired quality, raw material purity / availability, and furnace design will affect the batch recipe.



The hot end of a glassworks is where the molten glass is formed into glass products, beginning when the batch is fed into the furnace at a slow, controlled rate by the batch processing system (batch house). The furnaces are natural gas- or fuel oil-fired, and operate at temperatures up to 1,575°C. The temperature is limited only by the quality of the furnace's superstructure material and by the glass composition. Types of furnaces used in container

glass making include 'end-port' (end-fired), 'side-port', and 'oxy-fuel'. Typically, furnace "size" is classified by metric tons per day (MTPD) production capability.

Forming process



There are, currently, two primary methods of making a glass container: the blow and blow method, used for narrow-neck containers only, and the press and blow method used for jars and tapered narrow-neck containers.

In both methods, a stream of molten glass, at its plastic temperature (1050°C-1200°C), is cut with a shearing blade to form a solid cylinder of glass, called a gob. Both processes start with the gob falling, by gravity, and guided, through troughs and chutes, into the blank moulds, two halves of which are clamped shut and then sealed by the "baffle" from above.

In the blow and blow process the glass is first blown through a valve in the baffle, forcing it down into the three piece "ring mould" which is held in the "neckring arm" below the blanks, to form the "finish", [The term "finish" describes the details (such as cap sealing surface, screw threads, retaining rib for a tamper-proof cap, etc.) at the open end of the container.]

Containers are made in two major stages. The first stage moulds all the details ("finish") around the opening, but the body of the container is initially made much smaller than its final size. These partly manufactured containers are called parisons, and quite quickly, they are blow-molded into final shape.

Referring to the mechanism, the "rings" are sealed from below by a short plunger. After the "settleblow" finishes, the plunger retracts slightly, to allow the skin that's formed to soften. "Counterblow" air then comes up through the plunger, to create the parison. The baffle rises and the blanks open. The parison is inverted in an arc to the "mould side" by the "neckring arm", which holds the parison by the "finish".

As the neckring arm reaches the end of its arc, two mould halves close around the parison. The neckring arm opens slightly to release its grip on the "finish", then reverts to the blank side. Final blow, applied through the "blowhead", blows the glass out, expanding into the mould, to make the final container shape.

In the press and blow process, the parison is formed by a long metal plunger which rises up and presses the glass out, in order to fill the ring and blank moulds.^[5] The process then continues as before, with the parison being transferred to the final-shape mould, and the glass being blown out into the mould.

The container is then picked up from the mould by the "take-out" mechanism, and held over the "deadplate", where air cooling helps cool down the still-soft glass. Finally, the bottles are swept onto a conveyor by the "push out paddles" that have air pockets to keep the bottles standing after landing on the "deadplate"; they're now ready for annealing.



The forming machines hold and move the parts that form the container. The machine consists of basic 19 mechanisms in operation to form a bottle and generally powered by compressed air (high pressure - 3.2 bar and low pressure - 2.8 bar), the mechanisms are electronically timed to coordinate all movements of the mechanisms. The most widely used forming machine arrangement is the individual section machine (or IS machine). This machine has a bank of 5–20 identical sections, each of which contains one complete set of mechanisms to make containers. The sections are in a row, and the gobs feed into each section via a moving chute, called the gob distributor. Sections make either one, two, three or four containers simultaneously. (Referred to as single, double, triple and quad gob). In the case of multiple gobs, the shears cut the gobs simultaneously, and they fall into the blank moulds in parallel.

COMPOSITION OF GLASS

The following is a list of the more common types of silicate glasses, and their ingredients, properties, and applications:

1. Fused quartz, also called fused silica glass, vitreous silica glass, is silica (SiO_2) in vitreous or glass form (i.e., its molecules are disordered and random, without crystalline structure). It has very low thermal expansion, is very hard, and resists high temperatures (1000–1500 °C). It is also the most resistant against weathering (caused in other glasses by alkali ions leaching out of the glass, while staining it). Fused quartz is used for high temperature applications such as furnace tubes, lighting tubes, melting crucibles, etc.

2. Soda-lime-silica glass, window glass: silica 72% + sodium oxide (Na₂O) 14.2% + lime (CaO) 10.0% + magnesia (MgO) 2.5% + alumina (Al₂O₃) 0.6%. Is transparent, easily formed and most suitable for window glass (see flat glass). It has a high thermal expansion and poor resistance to heat (500–600 °C). It is used for windows, some low temperature incandescent light bulbs, and tableware. Container glass is a soda-lime glass that is a slight variation on flat glass, which uses more alumina and calcium, and less sodium and magnesium which are more water-soluble. This makes it less susceptible to water erosion.
3. Sodium borosilicate glass, Pyrex: silica 81% + boric oxide (B₂O₃) 12% + soda (Na₂O) 4.5% + alumina (Al₂O₃) 2.0%. Stands heat expansion much better than window glass. Used for chemical glassware, cooking glass, car head lamps, etc. Borosilicate glasses (e.g. Pyrex) have as main constituents silica and boron oxide. They have fairly low coefficients of thermal expansion (7740 Pyrex CTE is $3.25 \times 10^{-6} / ^\circ\text{C}$ ^[4] as compared to about $9 \times 10^{-6} / ^\circ\text{C}$ for a typical soda-lime glass^[5]), making them more dimensionally stable. The lower CTE also makes them less subject to stress caused by thermal expansion, thus less vulnerable to cracking from thermal shock. They are commonly used for reagent bottles, optical components and household cookware.
4. Lead-oxide glass, crystal glass: silica 59% + lead oxide (PbO) 25% + potassium oxide (K₂O) 12% + soda (Na₂O) 2.0% + zinc oxide (ZnO) 1.5% + alumina 0.4%. Because of its high density (resulting in a high electron density) it has a high refractive index, making the look of glassware more brilliant (called "crystal", though of course it is a glass and not a crystal). It also has a high elasticity, making glassware 'ring'. It is also more workable in the factory, but cannot stand heating very well.
5. Aluminosilicate glass: silica 57% + alumina 16% + lime 10% + magnesia 7.0% + barium oxide (BaO) 6.0% + boric oxide (B₂O₃) 4.0%. Extensively used for fiberglass, used for making glass-reinforced plastics (boats, fishing rods, etc.) and for halogen bulb glass.
6. Oxide glass: alumina 90% + germanium oxide (GeO₂) 10%. Extremely clear glass, used for fiber-optic waveguides in communication networks. Light loses only 5% of its intensity through 1 km of glass fiber.^[6] However, most optical fiber is based on silica, as are all the glasses above.

PROPERTIES OF GLASS

The properties of glass are mainly governed by factors like composition of the constituents, state of surface, thermal treatment conditions, dimension of specimen etc.

Following are the properties of glass which have made the glass popular and useful:

- I. It absorbs, refracts or transmits light.

- II. It can take up a high polish and may be used as substitute for every costly gems.
- III. It has no definite crystalline structure.
- IV. It has no sharp melting point.
- V. It is affected by alkalis.
- VI. It is an excellent electrical insulator at elevated temperatures due to the fact that glass can be considered as an ionic liquid. The ions are not easily moved at room temperature because of the high viscosity. But when the temperature rises, the ions are permitted to flow and thus they will sustain an electric current.
- VII. It is available in beautiful colours.
- VIII. It behaves more as a solid than most solids in the sense that it is elastic. but when the elastic limit is exceeded, it fractures instead of deforming.
- IX. It is capable of being worked in many ways. it can be blown,drawn,or pressed. But it is strange to note that it is difficult to cast in large pieces.
- X. It is extremely brittle.
- XI. It is not usually affected by air and water.
- XII. It is not attacked by ordinary chemical reagents.
- XIII. It is possible to intentionally alter some of its properties such as fusability,hardness,refractive power etc. To suit different purposes.
- XIV. It is possible to obtain glasses with diversified properties. The glass may be clear, colourless, diffused and stained.
- XV. It is possible to weld pieces of glass by fusion.
- XVI. It is transparent and translucent. Transparency is the most used characteristic of glass and it is due to the absence of the free electron. For the same reason it also works as a good insulator.
- XVII. When it is heated , it becomes soft and soft with rise in temperature . it is ultimately transformed into a mobile liquid. The liquid when allowed to cool , passes to all deegres of viscosity. The property of glass has made its manufacturing process easy. It can also be formed into articles of desired shape. Thus the amorphousness of glass permits it to be blown, drawn from furnaces and continuously worked.
- XVIII. Due to advancement made in the science of the glass production , it is possible to make glass lighter than cork or softer than cotton or stronger than steel. The presence of glass however is considerably affected by foreign inclusions , internal defects and cords or chemically heterogeneous areas.
- XIX. The glass panes can be cleaned easily by anyone of the following methods-
 - [i]By applying methylated spirit
 - [ii] painting the glass panes with lime wash and leaving it to dry and then washing with clean water.
 - [iii] rubbing damp salt for cleaning paint spots and;
 - [iv]rubbing finely powdered chalk

13. REPAIR

1. Glossary of hyponyms related to repair

Repair

This is the action taken up on a building by patching up superficial defects and building finishes in order to bring back the architectural shape of the building so that all services start working and the functioning of building is resumed quickly. Repair does not pretend to improve the structural strength of the building

Reconstruction

If the original building or some elements of the building missing or critically damaged to carry out any repair, then they are re-created in all new, appropriate material. This is called reconstruction.

Rehabilitation

It is the act or process of making possible a compatible use for a property through repair, alterations, and additions while preserving those portions or features which convey its historical, cultural, or architectural values. Here, although emphasis is provided to retain and repair the historic materials but more liberty is provided to replacement because it is assumed the structure severely damaged is severely damaged prior to work.

Retrofit

Retrofitting is the process of upgrading the building which is still in good condition; so that it becomes safe against future damage which may likely occur in near future. Thus retrofit involves making changes to the buildings at some point after its initial construction and occupation.

2. Building joints

A joint is a simple groove cut positioned on the surface of the concrete. These are provided to allow some cracking to occur there

Control/Contraction Joints

The purpose of a control joint is to divide a large area (brick, concrete, etc.) into smaller areas to make cracking less likely or to encourage any cracking to occur in the selected location. Control joints are usually non-working joints, except in the case of a brick wall where they act to accommodate expansion and contraction due to heating and cooling.

Isolation/ expansion joints

An isolation joint prevents movement in one part of a building from affecting other parts of the building. The most common isolation joint is the "expansion joint." Every building has major expansion joints that divide the building into segments; these joints go through the structure such as a wall or a roof and are continuous through the entire building.

Construction joints

A construction joint is a joint in concrete where one placement of concrete ends and the next placement was begun after the setting up of previous work. They are typically placed at the end of a day's work but may be required when concrete placement is stopped for longer than the initial setting time of concrete.

3. Building cracks

A crack is a complete or incomplete separation of concrete or masonry into two or more parts produced by its breaking or fracturing. Cracks in buildings could be broadly classified as structural or non-structural type.

Structural crack: These occur due to *incorrect design, faulty construction or overloading* and these may endanger the safety of a building. E.g., extensive cracking of an RCC beam.

Non-structural crack: These cracks mostly developed due to internally induced stresses in buildings materials due to *moisture variations, temperature variation, elastic deformations, creep, chemical reaction, foundation movement, vegetation growth* etc. Non-structural cracks do not endanger safety of a building but may look unsightly and create a feeling of instability and impression of faulty construction. Sometimes, these cracks may allow penetration of moisture through them thus resulting in damages to internal finishes or corrosion of reinforcement thus affecting stability of structure in long run.

4. Types of building repairs

Day-to-day Repair

These repairs include service repairs which need to be attended on day to day basis during the services of the building. Examples for such repairs are removing chokage of drainage pipes, man holes, restoration of water supply, replacement of blown fuses, repairs to faulty switches, watering of plants, lawn mowing, hedge cutting, sweeping of leaf falls etc. The purpose of this maintenance service is to ensure satisfactory continuous functioning of various services in the buildings.

Annual or Periodic Repairs

These are the regular repair works which are carried out at a longer time intervals, say one year, to maintain the aesthetics of buildings and services as well as to preserve its life.

Special Repair

Special repairs of building are undertaken to replace the existing parts of buildings and services which get deteriorated on ageing of buildings. It is necessary to prevent the structure and services from deterioration and restore it back to its original conditions to the extent possible. Extensive floor improvement, replacement of roof tiles, major joinery replacement normally falls under this category.

5. Maintenance of Buildings

Building maintenance is work undertaken to keep, restore or improve every part of a building, its services to a currently acceptable standard and to sustain the utility and value of the facility. Building maintenance works can be classified into three categories: *preventive maintenance*, *routine maintenance* and *corrective maintenance*.

Preventive Maintenance (/Breakdown maintenance)

Preventive maintenance is carried out to avoid breakdown of machinery and occurrence of maintenance problems in buildings and services.

Routine Maintenance

This is the most frequently done activity of all and is done by performing routine and scheduled maintenance of the property. Changing equipment filters, cleaning gutters, removing debris from roof drains, caulking, office cleaning, window cleaning and repairs, and parking lot care are just a few of the many items that require scheduled maintenance.

Corrective Maintenance

These are actual repairs that keep the property functioning normally and usually need to be done as soon as possible. The repairs are usually done in response to something breaking or not working properly anymore. This type of maintenance includes replacing a broken air conditioning unit, fixing a dripping faucet, unclogging drains, replacing light bulbs, or repairing a non-functioning toilet.

14. STONES

DEFINITION- The process of taking out stones from natural rock beds is known as the quarrying. The term quarry is used to indicate the exposed surface of natural rocks. The stones, thus obtained, are used for various engineering purposes. The difference a mine and quarry should be noted. In case of a mine, the operations are carried out under the ground at great depth. In case of quarry, the operations are carried out at ground level in an exposed condition.

SITE FOR QUARRY-The selection of site for a quarry of stones should be done after studying carefully the following aspects:

1. Availability of tools, power, materials and labour for the efficient working of quarry.
2. Easy availability of clean water in sufficient quantity all the year round.
3. Economy in quarrying.
4. Drainage of quarrying pit.
5. Facility of carrying and conveying stones from quarry.
6. Quality of stone available from quarry.

METHODS OF QUARRYING-

Following are the three methods of quarrying:

- I. Quarrying with hand tools
- II. Quarrying with channeling machine
- III. Quarrying with blasting.

QUARRYING WITH HAND TOOLS-There three methods of doing this type of quarrying:

- a) Digging or Excavating
 - b) Heating
 - c) Wedging
- (a) Digging or Excavating- In this method, the stones are merely excavating with the help of suitable instruments such as pick-axes, hammers, showels, chisels, etc. This method is useful when a soft stone occurs in form of large and small blocks.
- (b) Heating- In this method, the top surface of rock is heated. This method is useful when small blocks of more or less regular shape are to be taken out from quarry. It is suitable when the rock formation consists of horizontal layers of shallow depth. It is possible to obtain by these method fairly rectangular blocks required for coursed rubble masonry.
- (c) Wedging-In this method, if rock surface contains cracks or fissures, the steel wedges or points, as shown in fig., are driven through such cracks by means of hammers. The blocks of stones are then shifted and they are removed with the help of suitable instruments.

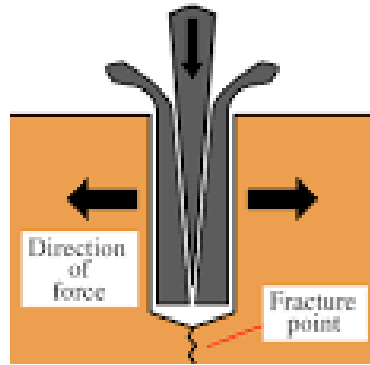

The wedging is adopted for costly stratified rocks which are comparatively soft such as laterite, marble, limestone, sandstone, etc. The wedging is preferred to the blasting, wherever possible.

QUARRYING WITH CHANNELLING MACHINE: In this method, the channelling machine driven by steam, compressed air or electricity are used to make vertical or oblique grooves or channels on the rock mass. These machines make rapidly the grooves having length of about 24m, width of about 50mm to 75mm and depth of about 2.40m to 3.70m. The process consists of the following steps:

- (a) The channels are cut around the stone block which is to be removed from the rock mass.
- (b) The horizontal holes are drilled beneath the rock.
- (c) The wedges are driven into the holes and the block is then broken loose from its bed.

QUARRYING WITH BLASTING: In this method, the explosives are used to convert into small pieces of stones. The main purpose of quarrying stones by is to loosen large masses of rocks and not to violently blow up the whole mass so as to convert it into very small pieces of practically no use.

This method is adopted for quarrying hard stones, having no fissures or cracks. The stones obtained by blasting are usually of small size and they are used as ballast in railways, aggregate for concrete, road metal, etc. The process of blasting is important with respect to the stone quarrying.

Commonly used Stones in India.

Marble:

- Origin and composition: - it is a most common variety of metamorphic rock. It is formed from crystallized limestone by metamorphism, chemically, it is calcareous and is chiefly composed of calcium carbonate.
- properties :- following are the properties of marble: _
- its crushing strength is from 500 to 600 kg/cm²

- the usual color of marble is white, but it is also available in different shades of colors such as grey, black, red, brown, yellow and combination of these
- it is compact and crystalline in structure due to which it can take a fine polish
- it is less durable
- It can be carved easily and thus is most suited for sculpture work.
- its specific gravity is 2.72 its weight 2720 kg/cum
- its absorption is 1 to 3%
- Chief uses:- used as building stone and in decorative panels

Sandstone:

- Origin and composition:-This stone is a common variety of sedimentary rocks mechanical origin. it is physically, stratified and chemically, siliceous in nature, it is chiefly composed of quartz (grains of sand) bound together by a cementing material, but other minerals such as feldspar, mica, magnetite etc. are also present.
- Properties:- following are the properties of sand stone:-
- its crushing strength is 400 to 650 kg/cm²
- It is white, grey, yellow, light brown, and red in color.
- Its specific gravity is 2.3 to 2.4. Its weight is nearly 2350 kg/cu m.
- Chief uses: - general walls building flagstone.

Slate:

- its crushing strength varies from 700 to 2100 kg/cm²
- it is hard tough and is least absorptive
- It also offers good abrasive resistance.
- It is a good heat and electrical insulator.
- Its water absorption varies from 0.5 to 1%.
- Following are the uses of slate.
- It is a valuable material for roofing and black boards.
- Thick slabs of harder variety of slates are used for flooring steps shelves mantel pieces sills of doors and window etc.
- slate is available at the following localities in India:
 - simla, kangra, gurgaon, Gurdaspur, Alwar, Rajasthan, (MP) (Haryana) (Gujarat)

Basalt:-

- Origin and Composition: these stones are the common varieties of igneous rocks they are formed by solidification of lava on the earth's surface due to volcanic eruption. Some basalts develop step like appearance and are known as traps. They are chiefly composed of silica, alumina and feldspar.
- Properties:- Following are the properties of basalt and trap
- Their crushing strength is 700 to 850 kg/sq.cm.
- They are hard and tough

- They are greenish grey to dark grey in color.
- Their specific gravity (2.9 to 2.96) is more than that of granite their weight is nearly 2900kg/cm³.
- They are available as a vast deposit of basaltic rock, near the western Ghats of India, known as Deccan trap. They are also available at Rajmahal Hills (Bihar) known as Rajmahal Trap. Varieties of basalts like, Bombay Basalt, Blue basalt, red basalt and yellow basalt are found and used in Maharashtra, Gujarat etc.

Limestone :-

- Color :- White light grey to light buff.
- Texture :- fine to crystalline, may have fossils
- Parting :-parallel to beds: also may have irregular fractures.
- Hardness:- fairly soft steel easily catches
- May show fossils.
- All lime stone are of sedimentary origin and have for their principal ingredient carbonate of lime.
- When clay is present, the stone is called argillaceous limestone; when silica predominates, siliceous limestone; when iron is prevalent, ferruginous limestone; when magnesia is present to the extent of 15 per cent.

Granite:-

- Granite is one of the most valuable stones for construction purposes. Although the quality of granite varies according to the proportions of the constituents and to their method of aggregation, this kind of stone is generally durable, strong, and hard.
- The hardest and most durable granites contain a greater proportion of quartz and a smaller proportion of feldspar and mica. Feldspar makes granite more susceptible to decomposition by the solution potash contained in it, potash feldspar being less durable than lime or soda feldspar.
- Because of its uniform structure, granite can be quarried in large blocks. The rift, the grain, and the joint planes are advantageous in quarrying, as it is very difficult to cut granite in other places. The uses for which granite is suitable depend on the texture of the stone. Medium-grained stone is best fitted for building construction. Fine-grained stone can be carved and polished.

Schist:-

- Schist has a more crystalline structure than slate, and the crystals are easily seen. It is composed chiefly of minerals that cleave readily, such as hornblende, mica, etc., mixed with a variable amount of granular quartz and feldspar. The presence of the cleavage minerals produces a fine cleavage or foliation, called schistosity.

- Schist is sometimes used in building construction but it disintegrates very rapidly and is not durable. It should always be set with the planes of schistosity horizontal.

Gneiss -

- Gneiss is a coarse-grained laminated rock.
- It is formed by metamorphism of either sedimentary or igneous rock.
- It is often used as structural material and as concrete aggregate.

Shale -

- Shale is a typical clay rock that splits readily in lines parallel to the bedding.
- Sand and lime carbonate are always present in this stone and, with increase of either, the rock grades into shaly sandstone or shaly limestone.
- Shale is used for light traffic roads and in the manufacture of brick, tile, and other burned clay products, but it is not suitable for concrete aggregate.

Conglomerate -

- Stratified rock composed of rounded pebbles of any material, such as limestone, quartz, shale, granite grains, feldspar, etc., cemented together is known as conglomerate.
- When the pebbles are quartz with siliceous binding the rock is strong and hard to quarry or dress.
- When the interstices between the pebbles are not filled by the binder, the rock is very porous, and may hold great amounts of ground water.
- This stone is seldom used in building construction.

15. TIMBER

A tree basically consists of three parts namely, trunk, crown and roots. The function of the trunk is to support the crown and to supply water and nutrients from the roots to the leaves through branches and from the leaves back to the roots. The roots are meant to implant the trees in the soil, to absorb moisture and the mineral substances it contains and to supply them to the trunk.

Details of structure:

From the visibility aspect, the structure of tree can be divided into two categories :-

- (1). Macrostructure
- (2). Microstructure

Macrostructure:-

The structure of wood visible to the naked eye or at a small magnification is called the macrostructure. Following are its different components:

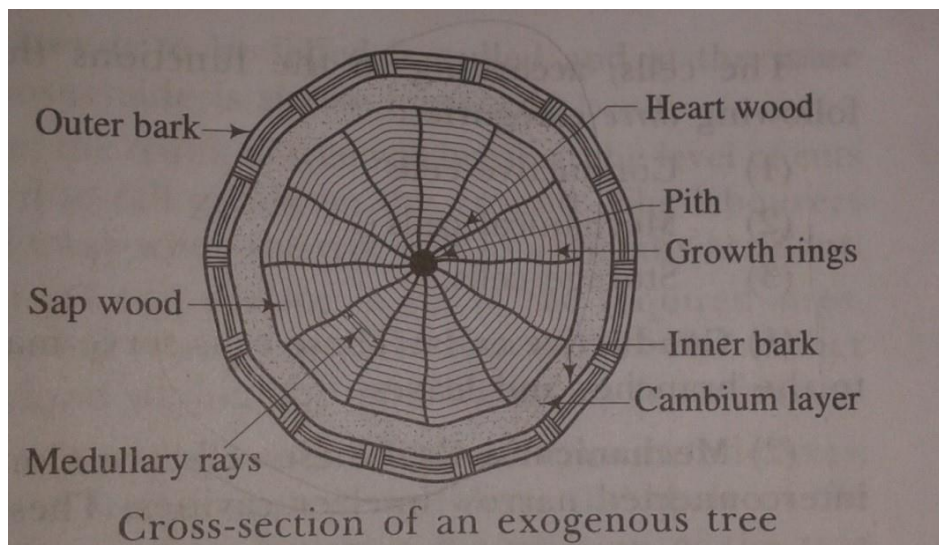

(1) Pith:

The innermost central portion of the core of the tree is called the pith or medulla. It varies in size and shape and for different types of trees. It consists entirely of cellular tissues and it nourishes its plant at its young age. When the plant becomes old, the pith dies up and decays and the sap is then transmitted by the woody fibres deposited round the pith. The pith of the branches is nothing but merely a prolongation of the stem.

(2) Heartwood:

The inner annular rings surrounding the pith constitute the heart wood. It is usually dark in colour. As a matter of fact, it indicates the dead portion of tree and as such, it does not take active part in the growth of the tree. But it imparts rigidity to the tree hence it provides strong and durable timber for various engineering purposes.

(3) Sapwood:

The outer annular rings between heartwood and cambium layer is known as sapwood. It is usually light in colour in light and weight. It indicates recent growth and it contains sap. The annual rings of sap wood are less sharply defined than those of heartwood. It takes active part in the growth of the tree and the sap moves in upward direction through it. The sapwood is also known as the alburnum.

(4) Cambium layer

The thin layer of sap between sapwood and inner bark is known as the cambium layer. It indicates sap which has not yet been converted into sap wood. If the bark is removed for any reason, the cambium layer gets exposed and the cells cease to be active resulting in the death of the fibre.

(5) Inner bark:

The inner skin or layer covering the cambium layer is known as the inner bark. It gives protection to the cambium layer from any injury.

(6) Outer bark

The outer skin or cover of the tree is known as the outer bark. It is the outermost protective layer and it sometimes contain cracks and fissures. It consists of cells and wood fibre and is also known as the cortex.

(7) Medullary rays

The thin radial fibres extending from pith to cambium layer are known as the medullary rays. The function of these rays is to hold together the annular rings of heartwood and sapwood. These rays are sometimes broken and in some varieties of trees, they are not very prominent.

Microstructure:

The structure of wood apparent only at great magnifications is called the microstructure.

A living cell consists of four parts namely membrane, protoplasm, sap and core. The cell membrane consists mainly of cellular tissues and cellulose. The protoplasm is a granular, transparent, viscous vegetable protein composed of carbon, hydrogen, oxygen, nitrogen and sulphur. The core of cell differs from protoplasm merely by the presence of phosphorus and it is generally oval.

The cells, according to the function they perform, are classified into the following three categories:

- Conductive cells

- Mechanical cells
- Storage cells

(1).conductive cells:

These cells serve mainly to transmit nutrient from root to the branches and leaves.

(2).mechanical cells

These cells are elongated ,thickwalledand have tightly interconnected narrow interior cavities.these cells impart strength to the wood.

(3).storage cells:

These cells serve to store and transmit nutrients to the living cells in the horizontal direction and they are usually located in the medullary rays.

Defects in timber:

Various defects occurring in timber are grouped into following five categories:

- (1)defects due to conversion
- (2)defects due to fungi
- (3)defect due to insects
- (4)defects due to natural forces
- (5)defects due to seasoning

Defects due to conversion:

During converting timber to commercial form the following defects may occur:

(i) **chip mark**: this defect is indicated by marks placed by chips on the finished surface of timber .they may also be formed by parts of a planing machine.

(ii)**Diagonal grain**: this defect is formed due to improper sawing of timber.it is indicated by diagonal mark on straight grained surface of timber.

(iii)**Torn grain**:this defect is caused when a small depression is formed on the finished surface of timber by falling of a tool or so.

(iv)**Wane**:this defects is denoted by the presence of original rounded surface on the manufactured piece of timber.

Defects due to fungi:

Fungi attack timber only when

- (1)The moisture content of timber is above 20%.
- (2)If there is a presence of air and warmth for the growth of fungi.

Due to attack of fungi following defects occur:

(i)**Bluestain**:the sap of the wood is stained to bluish colour by the action of certain type of fungi.

(ii) **Brown rot:**the fungi of certain types remove cellulose compound from wood and hence the wood assumes the brown colour.this is known as the brown rot.

(iii) **Dry rot:**the fungi of certain types feed on wood and during feeding ,they attack on wood and convert it into powder form.This is known as dry rot.

This type of defect occur in place where there is dampness and no free circulation of air.The dry rot may be prevented by using well seasoned timber free from sap.

(iv) **Heart rot:** this is formed when a branch has come out of a tree.It occurs when heart wood is exposed to atmospheric agent.

(v) **Sap stain:**certain types of fungi feed on cell contents of sap wood.In doing so ,the sap wood loses its colour.this is known as sap stain.It generally occurs when moisture content goes beyond 25 % or so.

(vi) **Wet rot:**some varieties of fungi cause chemical decomposition of wood of timber in doing so timber is converted into a greyish brown powder.This is known as wet rot.

(iv) **White rot:**this defect is opposite of brown rot.In this defect the wood assumes the appearance of a white mass consisting of cellulose compounds.

Defect due to insects:

Defects in timber occur due to various types of insects.

Such as:

(1) **beetles**

(2) **marine borers**

(3) **termites**

Decay of timber occurs due to the above insects.

Defect due to natural force:

The main natural forces responsible for causing defects in timber two,namely,abnormal growth and rupture of tissues.

(i) **Burls:**these are also known as the excrescences and they are particularly formed when a tree has received shock or injury in its young age. Due to such injury, the growth of tree is completely upset and irregular projections appear on the body of timber.

(ii) **Callus:**it indicates soft tissues or skin which covers the wound of a tree.

(iii) **Chemical stain:** the wood is sometimes discoloured by the chemical action caused with it by some external agency.

(iv) **Coarse grain:** if a tree grows rapidly, the annual rings are widened. Such timber possesses less strength.

(v) **Dead wood:** the timber which is obtained from dead standing trees contains dead wood.

(vi) **Druxiness:** this defect is indicated by white decayed spots which are concealed by healthy wood.

(vii) **Foxiness:** this defect is indicated by red or yellow tinge in wood or reddish brown stains or spots round the pith of tree discolouring the timber. It is caused due too poor ventilation.

(viii) **Knots:** these are the bases of branches or limbs which are broken or cut off from the tree. The portion from which the branch is removed receives nourishment from the stem for a pretty long time and it ultimately results in the formation of dark hard rings which are known as the knots.

(ix) **Rind galls:** the rind means bark and gall indicates abnormal growth. Hence peculiar curved swelling found on the body of a tree known as the rind gall.

(x) **Shakes:** these are cracks which partly or completely separate the fibres of wood. Following are the different types of shakes: cup shake, heart shake, ring shake, star shake, radial shake.

(xi) **Twisted fibres:** these are also known as the wandering hearts and they are caused by twisting of young trees by fast blowing wind.

(xii) **Upset:** these are also known as the ruptures and they indicate the wood fibres which are injured by crushing or compression.

(xiii) **water stain:** the wood is sometimes discoloured when it comes into contact with water. Thi defect is usually found in converted timber.

(xiv) **Wind cracks:**if wood is exposed to atmospheric agencies, its exterior surface shrinks. These are known as the wind cracks.

Defects due to seasoning:

Following defects occur in the seasoning process of wood.

(i) **Bow:** the defect is indicated by the curvature formed in the direction of length of timber.

(ii) **case-hardening:** the exposed surface of timber dries very rapidly. It therefore shrinks and is under compression. The interior surface which has not completely dried under tension. This defect is known as the case-hardening.

(iii) **Check:** a check is a crack which separates fibres of wood. It does not extend from one end to the other.

(iv) **Collapse:** due to uneven shrinkage, the wood sometime flattens during drying. This is known as collapse.

(v) **Cup:** this defect is indicated by the curvature formed in the transverse direction of timber.

(vi) **Honey-combing:** due to stresses developed during drying, the various radial and circular cracks in the interior portion of timber. This defect is known as honey-combing.

(vii) **Radial shake:** these are radial cracks.

(viii) Split: when a check extends from one end to the other, it is known as a split.

(ix) Twist: when a piece of timber has spirally distorted along its length, it is known as a twist.

(x) Warp: when a piece of timber has twisted out of shape, it is said to have warped.

TIMBER

TIMBER is the oldest material used by humans for construction after stone. Despite its complex chemical nature, wood has excellent properties which lend themselves to human use. It is readily and economically available; easily machinable; amenable to fabrication into an infinite variety of sizes and shapes using simple on-site building techniques;

- Exceptionally strong relative to its weight
- A good heat and electrical insulator
- It is a renewable and biodegradable resource.

However, it also has some drawbacks of which the user must be aware. It is a “**natural**” material and is available in limited amount.

Preservation:

Preservation of timber means protecting timber from fungi and insects attack so that its life is increased. Timber is to be seasoned well before application of preservatives. The following are the widely used preservatives:

1. Tar
2. Paints
3. Chemical salt
4. Creosote
5. ASCO

1. Tar

Hot coal tar is applied to timber with brush. The coating of tar protects the timber from the attack of fungi and insects. It is a cheapest way of protecting timber. Main disadvantage of this method of preservation is that appearance is not good after tar is applied it is not possible to apply other attractive paints. Hence tarring is made only for the unimportant structures like fence poles.

2. Paints

Two to three coats of oil paints are applied on clean surface of wood. The paint protects the timber from moisture. The paint is to be applied from time to time. Paint improves the appearance of the timber. Solignum paint is a special paint which protects the timber from the attack of termites.

3. Chemical salt

These are the preservatives made by dissolving salts in water. The salts used are copper

sulphate, masonry chloride, zinc chloride and sodium fluoride. After treating the timber with these chemical salt paints and varnishes can be applied to get good appearance.

4. Creosote

Creosote oil is obtained by distillation of coal tar. The seasoned timber is kept in an air tight chamber and air is exhausted. Then creosote oil is pumped into the chamber at a pressure of 0.8 to 1.0 N/mm² at a temperature of 50°C. After 1 to 2 hours timber is taken out of the chamber.

5.ASCO

This preservative is developed by the Forest Research Institute, Dehradun. It consists of 1 part by weight of hydrated arsenic pentoxide (As₂O₅, 2 H₂O), 3 parts by weight of copper sulphate. (CuSO₄·5 H₂O) and 4 parts by weight of potassium dichromate (K₂Cr₂O₇) or sodium dichromate (Na₂Cr₂O₇·2 H₂O). This preservative is available in powder form. By mixing six parts of this powder with 100 parts of water, the solution is prepared. The solution is then sprayed over the surface of timber. This treatment prevents attack from termites. The surface may be painted to get desired appearance.

Physical Properties:

Specific Gravity (SG):

Generally, specific gravity (SG) and the major strength properties of wood are directly related. SG for the major, usually used structural species ranges from roughly 0.30 to 0.90. Higher allowable design values are assigned to those pieces having narrower growth rings (more rings per inch) or more dense latewood per growth ring and, hence, higher SG.

Thermal Properties/Temperature Effects:

Although wood is an excellent heat insulator, its strength and other properties are affected adversely by exposure for extended periods to temperatures above about 100°F. The combination of high relative humidity or MC and high temperatures, as in unventilated attic areas, can have serious effects on roof sheathing materials and structural elements over and above the potential for attack by decay organisms. Simple remedies and caution usually prevent any problems.

At temperatures above 220°F, wood takes on a thermoplastic behavior. This characteristic, which is rarely encountered in normal construction, is an advantage in the manufacture of some reconstituted board products, where high temperatures and pressures are utilized.

Environmentally friendly

Timber is the most environmentally responsible building material. Timber has low production energy requirements and is a net carbon absorber. Timber is a renewable resource. Well-managed forests produce timber on a sustained continuous basis, with minimal adverse effects on soil and water values.

In plentiful and growing supply

Timber is readily available. Australia has significant forest resources including a plantation estate covering more than 1.6 million hectares, and the area is growing rapidly.

Strong and lightweight

Timber is strong, light and reliable making timber construction simpler and safer than steel or concrete construction. A comparison with steel and concrete shows that radiata pine structural timber, for example, has a strength for weight ratio 20 percent higher than structural steel and four to five times better than unreinforced concrete in compression. The lightweight structures possible in wood confer flow-on advantages in terms of reduced foundation costs, reduced earthquake loading and easier transport. Building components and complete constructions are simple and safe to erect, and cheaper to deconstruct or reuse at the end of a building's useful life.

Chemical Properties

Though, wood is chemically inert as compared to other materials but is affected by some acids and bases. Some species have proven very useful for food containers (berry boxes and crates) because they are nontoxic and impart no taste to the foods contained therein. Wood structures have also found widespread use as storage facilities for salt and fertilizer chemicals

DRY ROT

The turning of timber tissues to almost dry powder by fungi is called dry rot. The fungus feed upon the wood and eats the wood tissue, thus penetrating the wood fibres from all directions.

Prevention:

1. well seasoned timber should be used.
2. timber should be used where there is free circulation and access of air.

Remedy:

1. the timber should be painted with a solution of copper sulphate
2. the high temperature of seasoning of kiln helps in killing the Fungi.

WET ROT

The disintegration of tissue of timber due to alternate wetting and drying is called wet rot. The attacks take place through the wounds in bark by the access of water.

Prevention:

All timber for exterior or underground work should be first properly seasoned and then coated with tar to keep out the dampness.

Remedy:

The best remedy for treating wet rot is by using a suitable preservative

Seasoning of Timber

From day to day, most people have some contact with "seasoned" timber. From childhood days woodcots and toys, to school desks and, eventually, to wooden furniture and flooring in homes or places of employment - seasoned timber is to be found. Yet how many people really understand what seasoned timber is?

Only when cracks appear in furniture or floor, or when a door shows some degree of warping, is any thought given to this concept. It is to be regretted that even some people associated with the timber trade have little knowledge of what seasoned timber is and the best method of obtaining it.

What is "seasoned" timber?

The process of drying out the water from "wet" or "green" timber is termed "seasoning", or more simply "drying". Water is just as essential to the life of a tree as it is for all living matter. Together with the various minerals, it enters through the roots of the tree and is carried in the sapwood - the outer woody part to the leaves. The food, that is the sugars and starch, are made in the leaves by photosynthesis and are transported in solution down the inner bark to the growing cells. The whole trunk of the tree is made up of cells, which are like small tubes, having walls of cellulose and a more or less hollow cavity filled with water and other materials known as sap. Consequently, when the tree is felled and the resulting logs are sawn into timber, the sawn sections consist of innumerable small cells containing water. Drying the moisture out of wood enhances its properties to such an extent that the resulting timber is given the special name "seasoned" rather than "dried" although the terms are identical.

Why is timber seasoned?

Seasoning timber causes many changes in its properties, and in practically every case the change is an improvement. There is only one principal disadvantage in drying timber, namely, the loss in volume due to shrinkage. However, by a correct understanding of the shrinkage of timber this effect can be minimized, and timber can then be confidently used without fear of adverse behaviour subsequently in service.

Types of Seasoning

- (i) **Natural Seasoning:** It may be air seasoning or water seasoning. Air seasoning is carried out in a shed with a platform. On about 300 mm high platform timber bunks are stacked as shown in Fig. 1.8.
- (ii) Care is taken to see that there is proper air circulation around each timber bunc. Over a period, in a natural process moisture content reduces. A well-seasoned timber contains only 15% moisture. This is a slow but a good process of seasoning. Water seasoning is carried out on the banks of rivers. The thicker end of the timber is kept pointing upstream side. After a period of 2 to 4 weeks the timber is taken out. During this period sap contained in the timber is washed out to a great extent. Then timber is stacked in a shed with free air circulation.

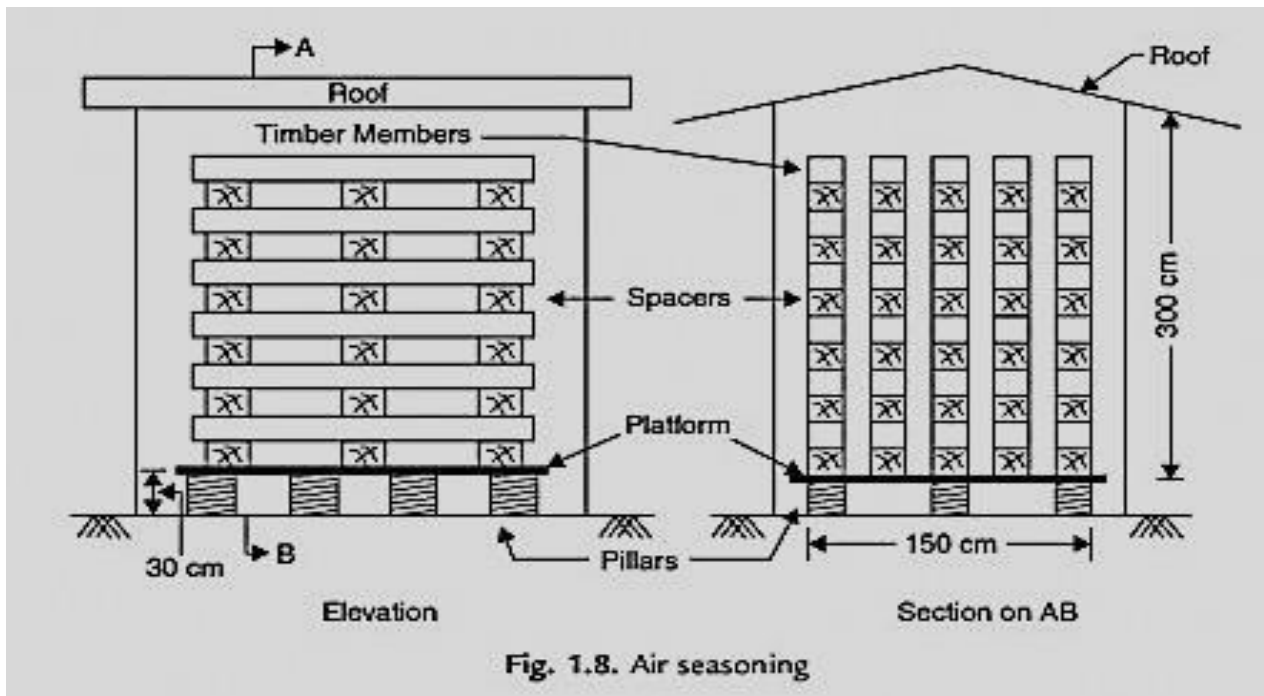

(iii) **Artificial Seasoning:** In this method timber is seasoned in a chamber with regulated heat, controlled humidity and proper air circulation. Seasoning can be completed in 4 to 5 days only. The different methods of seasoning are:

- (a) Boiling
- (b) Kiln seasoning
- (c) Chemical seasoning
- (d) Electrical seasoning.

(a) **Boiling:** In this method timber is immersed in water and then water is boiled for 3 to 4 hours. Then it is dried slowly. Instead of boiling water hot steam may be circulated on timber. The process of seasoning is fast, but costly.

(b) **Kiln Seasoning:** Kiln is an airtight chamber. Timber to be seasoned is placed inside it. Then fully saturated air with a temperature 35°C to 38°C is forced in the kiln. The heat gradually reaches inside timber. Then relative humidity is gradually reduced and temperature is increased, and maintained till desired degree of moisture content is achieved.

The kiln used may be stationary or progressive. In progressive kiln the carriages carrying timber travel from one end of kiln to other end gradually. The hot air is supplied from the discharging end so that temperature increase is gradual from charging end to discharging end. This method is used for seasoning on a larger scale.

(c) **Chemical Seasoning:** In this method, the timber is immersed in a solution of suitable salt. Then the timber is dried in a kiln. The preliminary treatment by chemical seasoning ensures uniform seasoning of outer and inner parts of timber.

(d) **Electrical Seasoning:** In this method high frequency alternate electric current is passed through timber. Resistance to electric current is low when moisture content in timber is high.

As moisture content reduces the resistance reduces. Measure of resistance can be used to stop seasoning at appropriate level.

However it is costly process. This technique has been tried in some plywood industries but not in seasoning of timber on mass scale.

Different methods of seasoning:

Air Seasoning

The traditional method for drying wood, air seasoning is also the longest, taking six to nine months. To air season wood, stack logs or planks outside on pallets in such a manner that air can circulate vertically and horizontally through the timbers. The raised pallets also keep wood away from vegetation and damp ground. Plank and log ends are often wrapped or sealed to prevent excessive moisture loss through these areas. Protect the drying wood from the elements with an overhead canopy.

Kiln Seasoning

The most common and effective commercial process for drying wood is kiln seasoning, which accelerates the process of removing moisture through the use of external energy. Drying takes two days to one weekend, depending on the type of wood. Two methods, progressive and compartmental, are used for kiln seasoning. In a progressive kiln, timber enters at one end and travels on a trolley through chambers with different air conditions to progressively dry the wood. This method produces a constant flow of seasoned timber. Wood seasoned via the compartmental process remains in a single building where it is subjected to a program of varying conditions until the moisture content is removed. This process is used for hard-to-dry or expensive wood.

Solar Kiln

This method combines the speed of kiln seasoning with the low energy of air drying. Solar kilns have single-thickness windows on the south side of the structure that work as collectors to trap the sun's energy. Heat collectors, made from black metal are attached near the top of the window sashes. Various methods force the heated air to circulate through the kiln to dry the wood. Some solar kilns have insulation to retain heat at night. This process takes approximately twice as long as traditional kiln seasoning. Because of its gentle nature, it is well suited to producing wood for furniture fabrication.

Microwave Seasoning

Microwave seasoning uses pulsed energy directed into timbers to drive out moisture in a manner that will not cause seasoning degrade. This method also provides advantages such as high speed and high quality and is well suited for seasoning lumber, blocks, veneer, chips, paper and wood-based composite materials. Areas in the wood with the most moisture absorb the most energy resulting in even temperature during the drying process and a uniform moisture content. These factors enhance quality and reduce timber checking and warping.

Advantages of seasoning:

Three most important advantages of seasoning have already been made apparent:

1. Seasoned timber lasts much longer than unseasoned. Since the decay of timber is due to the attacks of wood-destroying fungi, and since the most important condition of the growth of these fungi is water, anything which lessens the amount of water in wood aids in its preservation.

2. In the case of treated timber, seasoning before treatment greatly increases the effectiveness of the ordinary methods of treatment, and seasoning after treatment prevents the rapid leaching out of the salts introduced to preserve the timber.

3. The saving in freight where timber is shipped from one place to another. Few persons realize how much water green wood contains, or how much it will lose in a comparatively short time. Experiments along this line with lodge-pole pine, white oak, and chestnut gave results which were a surprise to the companies owning the timber.

Freight charges vary considerably in different parts of the country; but a decrease of 35 to 40 per cent in weight is important enough to deserve everywhere serious consideration from those in charge of timber operations.

When timber is shipped long distances over several roads, as is coming to be more and more the case, the saving in freight will make a material difference in the cost of lumber operations, irrespective of any other advantages of seasoning.

16. FOUNDATION

The selection of the foundation type for a particular site depends on the following considerations:

1. Nature of subsoil.
2. Nature and extent of difficulties
3. Availability of expertise and equipment

Depending upon their nature and depth, foundations have been categorized as follows:

- (i) Open foundations or shallow foundations
- (ii) Deep foundations

OPEN FOUNDATIONS

This is the most common type of foundation and can be laid using open excavation by allowing natural slopes on both sides. This type of foundation is practicable for a depth up to 5m and is normally convenient above the water table. The base of the structure is enlarged or spread to provide individual support. Since spread foundations are constructed in open excavations, therefore they are termed as open foundations. The various types of spread footings are:

1. Wall footings,
2. Isolated footings,
3. Combined footings,
4. Inverted arch footings,
5. Continuous footings
6. Cantilever footing
7. Grillage footing

- 1. Wall Footings:** These footings can either be simple or stepped. The base course of these footings can be concrete or of entirely one material. They have only one projection beyond the width of the wall on either side. The width of the concrete base should be at least equal to twice the width of the wall. The depth of the concrete bed is at least equal to the projection. Generally the projection provided in the footing is 15cm, on either side

and the concrete mix comprises of cement, sand and aggregate in proportion of 1:3:6 or 1:4:8.

2. **Isolated or Column Footings:** They are used to support individual columns. In case of heavy loaded columns, steel reinforcements is provided. Generally, 15cm offset is provided on all sides of concrete bed. The footing of concrete columns may be slab, stepped or sloped type.
3. **Combined Footings:** A combined footing supports two or more columns in a row. The combined footing can be rectangular in shape if both the columns carry equal loads or can be trapezoidal if both the loads are unequal. Generally they are constructed of reinforced concrete. The location of the center of the gravity of the column loads and centroid of the footing should coincide.
4. **Inverted arch footing:** This type of footing is used on soft soils to reduce the depth of the foundation. Loads above an opening are transmitted from supporting walls through inverted arches to the soil. In this type of footings the end columns must be stable enough to resist the outward pressure caused by the arch action.
5. **Continuous footings:** In this type of footing a single continuous R.C. slab is provided as foundation of two or three or more columns in a row. This type of footing is suitable at locations liable to earthquake activities. This also prevents differential settlements in structures.
6. **Strap or cantilever footings:** Strap footing consists of two or more individual footings connected by a beam called strap. This type of footing is used where the distance between the columns is so great that the trapezoidal footing becomes quite narrow with bending moments.
7. **Grillage footings:** this type of footings is used to transmit heavy loads from steel columns to the soils having low bearing power. This type of arrangements prevents deep excavations and provides necessary area at base to reduce the intensity of the pressure.

RAFT FOUNDATIONS

A raft or mat is a combined footing that covers the entire area beneath a structure and supports all the columns. They are used where the soil mass contains compressible lenses so that the differential settlement would be difficult to control. Raft foundation is also used to reduce the settlement above highly compressible soils by making the weight of the structure and raft approximately equal to the weight of the soil excavated. The raft is composed of reinforced concrete beam with a relatively thin slab underneath.

DEEP FOUNDATIONS

These foundations carry loads from a structure through weak incompressible soils or fills on to the stronger and less compressible soils or rocks at depth. These foundations are in general used as basements, buoyancy rafts, caissons, cylinders, shaft and piles

1. Basements. They are constructed in place in an open excavations. They are hollow substructures designed to provide working space below ground level.

2. Buoyancy Rafts. They are hollow substructures designed to provide a buoyant substructure beneath which reduce net loadings on the soil to the desired low density.

3.Caissons. They are hollow substructures designed to be constructed on or near the surface and then sunk as single units to their required level.

4.Cylinders. They are single small cell caissons.

5.Shaft Foundations. They are constructed within deep excavation supported by lining constructed in place and subsequently filled with concrete.

6.Pile Foundations. The pile foundation is a construction supported on piles. A pile is an element of construction composed of timber, concrete or steel or a combination of them. The piles may be placed separately or they may be placed in form of a cluster throughout the structure.

Classification of piles:

1. Classification based on function: Bearing Pile, Friction Pile, Screw Pile, compaction Pile, Uplift Pile, Batter Pile and Sheet Pile
2. Classification based on materials and composition: Cement concrete piles, Timber piles, Steel piles, Sand Piles, and Composite piles.

CONSTRUCTION TECHNOLOGY

SUBJECT CODE-CET 305

3RD SEMESTER

TOPICS TO BE COVERED:-

- INTRODUCTION
- SITE INVESTIGATION
- FOUNDATION
- WALLS
- DAMP PROOFING
- ARCHES & LINTELS
- DOORS & WINDOWS
- FLOORS
- ROOFS
- STAIRS
- SURFACE FINISHES
- GENERAL IDEA OF SEISMIC PLANNING & DESIGN OF BUILDING
- CONSTRUCTION MACHINERIES

TOTAL MARKS=100

END SEMESTER EXAMINATION =70

CLASS TEST =20

TEACHER ASSESSMENT =10

TEXT BOOKS :-BUILDING CONSTRUCTION OF S C RANGAWALA

REFERENCE BOOK :-BUILDING CONSTRUCTION OF (i) S.P. ARORA & S.P. BINDRA

(II)SUSHIL KUMAR

(III)VERMA & MAHESH

CHAPTER -1

TOPICS TO BE COVERED

- *DEFINE BUILDING
- *CLASSIFICATION OF BUILDING
- * COMPONENTS OF BUILDING

INTRODUCTION

What is building?

A building is a structure used for the purpose of providing sheltered accommodation.

*It may be a residential building ,comprising of essential rooms like drawing room ,bed room , dining hall, kitchen , toilet etc.

*A non-residential building like shop ,office, school, theatre, hospital etc.

Components Of Residential Building

- *Drawing room
- *Bed room with attached toilet
- *Kitchen
- *Dining room
- *Guest room
- *Study room
- *Verandah

Building Components

A building structure consists of two parts

- 1.Foundation or Sub structure
- 2.Super structure

1.Foundation Or Substructure-It is the portion of the building below the ground level.

*It transmits the load coming from the super structure to the ground.

EX:-Footing ,p.c.c

2.Superstructure:-It is the portion of the building above the ground level.

*It includes plinth, flooring, DPC, windows, & ventilators, lintels & sunshades, roof, parapet wall.

CHAPTER -2

TOPIC TO BE COVERED

- *SITE INVESTIGATION
- *OBJECTIVES OF SITE INVESTIGATION
- *SITE RECONNAISSANCE
- *SITE EXPLORATION
- *METHODS OF SITE EXPLORATION

Site Investigation

What Is Site Investigation ?

It is desirable to visit the site of work & inspect the same carefully from the view point of foundation details. The nature & thickness of strata of soil may be estimated by studying the excavation details of nearby constructions or by examining the open side of a nearby well etc. The general inspection of site of work serve as a good guide for determining the type of foundation to be adopted for the proposed work.

Objectives Of Site Investigation

- *Behaviour of ground due to variations in depth of water table
- *Disposal of storm water at site
- *Nature of soil by visual examination
- *Movement of ground due to any reason, etc

Site Reconnaissance:-An inspection of the site & study of topographical features is often helpful in setting useful information about the soil & ground water conditions & in deciding the feature programme of exploration.

Site Exploration:-The object of the site exploration is to provide reliable, specific & detailed information about the soil & ground water conditions of the site which may be required for a safe & economic design of foundations.

Methods Of Site Exploration:-

The following methods of site exploration are as follows

1. Test pits
2. Probing
3. Auger boring
4. Wash boring
5. Test piles
6. Deep boring

1. Test Pits:-A square pit is known as trial pit or a test pit, with side as about 1.5m, is excavated up to a depth at which sufficiently hard soil is available.

*This method is useful when hard soil is available within a maximum depth of 1.5m.

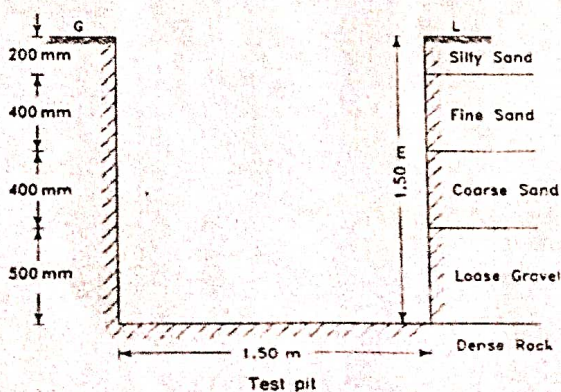

2. Probing:- The probing consists of a hollow tube or a steel rod or an iron rod in to the ground. A hollow tube of diameter 35mm to 50mm is taken . The tube is driven in to the ground 300mm or so at a time. It is then withdrawn & the material caught in the slit is inspected.

- *In other case, the rod is frequently withdrawn & the material stuck up at the pointed end is examined.
- *It is possible to examine the ground for a maximum depth of 3m.

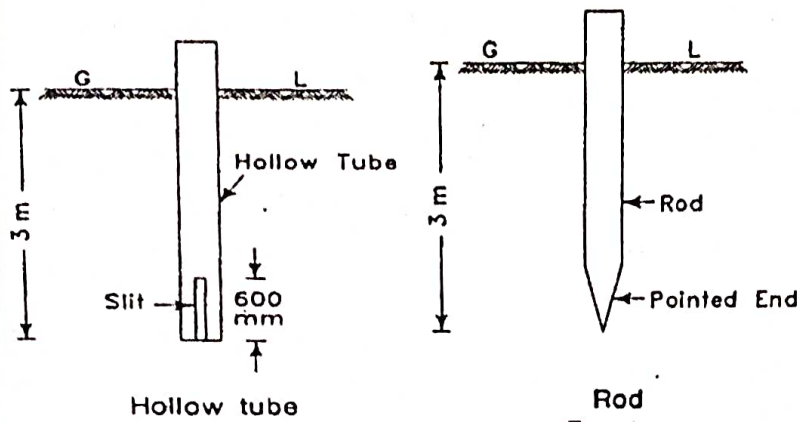

3. Auger Boring:- It consists of a hollow tube of diameter 75mm to 100mm. The tube is provided with a cutting edge at the bottom . A slit extending over a length of 600mm to 900mm is provided at the bottom of the tube to catch the material. The length of the tube is about 1.5m . The auger is driven in to the ground & turned like a screw. With the help of this method , it is possible to inspect the ground for a depth of 6m to 8m & in case of loose sand , the auger may be useful even up to a depth about 15m or so.

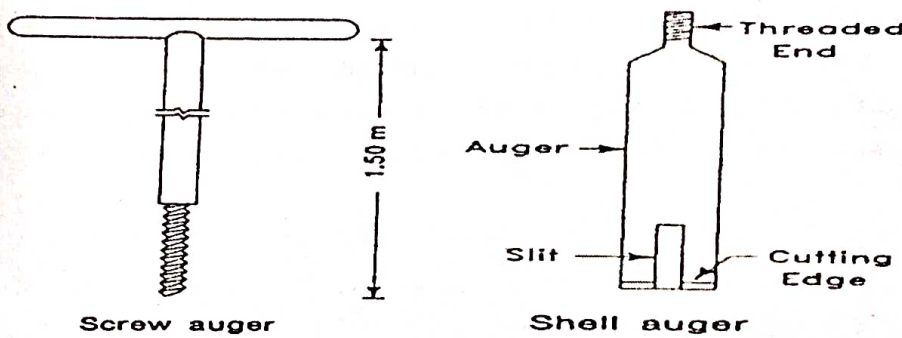

4. Wash Boring:-

The wash boring consists in driving an inner tube of diameter 25mm to 50mm, inside an outer tube of diameter 100mm to 150mm. The water is simultaneously forced with driving of tube under pressure through the inner tube. This facilitates easy driving of tube & makes the soil loose enough to flow through the annular space . The quantity of water required is usually about 100 to 300 litres per minute under a pressure of 36.28 KN/m². The process is continued till hard surface is met with. The washed material is collected in a tank.

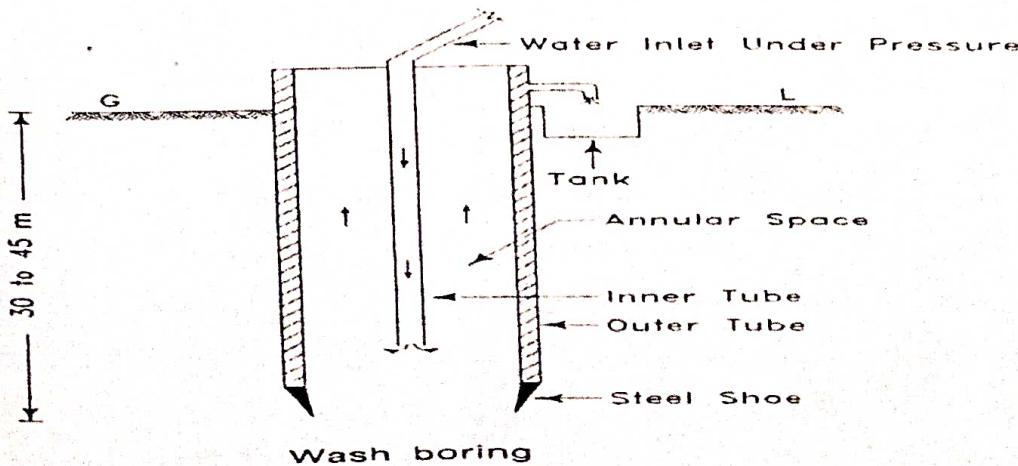

5. Test Piles:-

Test piles are driven in to the ground to obtain the information of solid strata. With the help of this process, it is not possible to know definitely the kinds of strata through which the test piles pass, as the material is not available for inspection.

6. Deep Boring:-

It becomes essential to carry out deep boring for big important engineering structures.

Ex:-Dams

*In such structures, in addition to the stability of the superstructure, the importance is to given to various other factors such as non-leakage of stored water, seepage through porous strata, etc.

*The machines used for deep boring are as follows;

(i)Percussion boring machine

(ii)Core or rotary drilling machine.

(i)Percussion Boring Machine:-In this process, the heavy cutting tool is dropped in to the ground by means of a series of blows. The broken material is brought to the ground by adding water in to the core. & then the paste is lifted to the ground. The material thus obtained is made dry & it is then examined. The percussion boring machine is very much use full for hard material like rock

(ii)Core Or Rotary Drilling Machine:-

In this process a hollow tube is driven by rotary motion which cuts a solid core. The water is used to facilitate the cutting process. The machine can be used either for a soft or hard material. The machine can be used either for soft or hard material. If the tube passes through the soft material, no core is obtained & the slurry formed has to be pumped out after the tube is withdrawn. When the tube passes through the hard material, no core is retained & this has to be cut at the bottom & lifted up. This is done by pouring sand at the inner side i.e. between the core & the inner surface of the tube & then the tube is slightly rotated. The core is then broken & caught in the tube & it is lifted up.

CHAPTER -3

FOUNDATIONS

TOPICS TO BE COVERED

- *CONCEPTS OF FOUNDATION AND PURPOSES*
- *TYPES OF FOUNDATIONS- SHALLOW AND DEEP*
- *SHALLOW FOUNDATION – CONSTRUCTIONAL DETAILS OF , SPREAD FOUNDATIONS FOR WALLS, THUMB RULES FOR DEPTH & WIDTH OF FOUNDATION AND THICKNESS OF CONCRETE BLOCK, STEPPED FOUNDATION, COMBINED FOOTING*
- *DEEP FOUNDATION:*

Definition of foundation:-

The lowest artificially prepared parts of the structures which are direct contact with ground and which transmit the loads of the structures to the ground are known as the foundation or substructure.

Purpose of foundation:-

- To distribute the total load coming on the structure on a larger area .
- To support the structure.
- To give enough lateral stability to the structures against various disturbing horizontal forces such as wind, rain, earth quake etc.
- To prepare a level and hard surface for concreting and masonry work.
- To distribute the non-uniform load of the superstructure evenly to the sub-soil.
- To provide the structural safety against undermining or scouring due to animals , flood water etc.
- To prevent or minimize cracks due to movement of moisture in case of weak or poor soil etc.

Types of foundation:-

(i) Shallow foundation

(ii) Deep foundation

(i) **Shallow foundation**:- Foundation is shallow means if its depth is equal to or less than its width. It is also known as open foundation.

(ii) **Deep foundation**:- Deep foundation are those in which the depth of the foundation is very large in comparison to its width .

Shallow foundation of footings are of following types:-

1. Spread footing
2. Combined footing
3. Strap footing
4. Mat or raft foundation

1. **Spread footing**:- A spread footing is the one which supports either one wall or column.

2. **Combined footing**:- It is the one which supports two columns .If the footing supports more than two columns .It is known as a continuous footing.

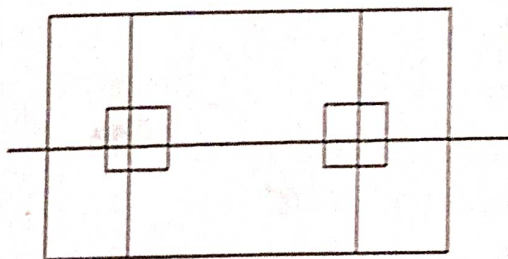

3. **Strap footing**:- A strap footing comprises of two or more footings of individual columns , connected by a beam , is called a strap.

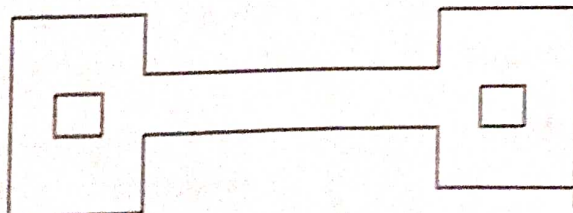

4. Mat or raft foundation :- It is a combined footing that covers the entire area beneath a structure & supports all the walls & columns.

- It is a foundation unit continuous in two directions covering an area equal to or greater than the base area of the building .
- When the allowable soil pressure is low or the building loads are heavy , the use of spread footing would cover more than one half of the area & it may prove more economical to use mat or raft foundation.

(ii) **Deep foundation:-** Deep foundation may be of the following types

1. Pile foundation
2. Pier foundation
3. Caisson or well foundation

1. Pile foundation:- It is that type of deep foundation in which the loads are taken to a low level , by means of a vertical members which may be of concrete, timber or steel.

Pile foundations are of the following types

- (a) End bearing pile
- (b) Compaction pile
- (c) Friction pile

(a) **End bearing pile :-** End bearing piles are used to transfer load through water or soft-soil to a suitable bearing stratum.

*Such piles are used to carry heavy loads safely to hard strata & the settlements are minimized.

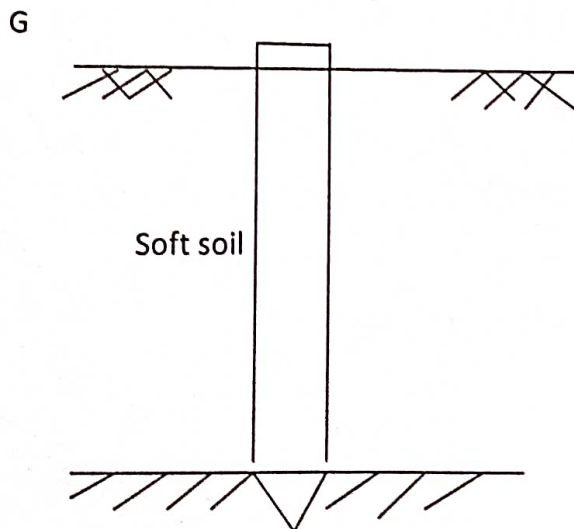

(b) **Friction pile:-** Friction piles are used to transfer load to a depth of a friction load carrying material by means of skin friction along the length of the pile . Such piles are used in triangular soil where the depth of hard strata is very deep.

(c) **Compaction pile:-** Compaction piles are used to compact loose granular soils, thus increasing their bearing capacity.

2. **Pier foundation**:- Pier foundation consists of a cylindrical column of a large diameter to support & transfer large super-imposed loads to the firm strata below.

3. **Well foundation**:- Well foundation or caisson's are box liked structure i.e. circular or rectangular which is sunk from the surface of either land or water to some desired depth.

Example:- Break water, sea walls

Bearing capacity of soil:- The load of the structure is ultimately coming on the soil and hence it is of utmost importance to know the strength and behaviour of the soil. The term bearing capacity or bearing power of soil is use to indicate the maximum load per unit area which the soil will resist safely with displacement.

Bearing capacity of soil in $\text{KN/m}^2 = \text{Maximum load} / \text{Area of steel plate}$

Design of shallow foundation:-

Following data are required before the design of shallow foundation:-

- The total load to be transmitted by the wall or pier to the foundation bed.
- The results of trial pits and the corresponding bearing capacity of each strata of soil.
- The design of shallow foundation involves two aspects:-
 - (i) Width of foundation
 - (ii) Depth of foundation

(i) Width of foundation:-

- If no footings are to be provided to the wall that is for simple footing. The width of foundation should be equal to three times of the thickness of wall.
- The total load including dead load, wind load, live load, coming on the wall per meter length or in case of a pair at the centre of pair is worked out.
- Then the width of the foundation is obtained in following relation

For walls:-

Width of foundation = Total load per metre length / Allowable bearing capacity of soil

For piers:-

Width of foundation = Total load on the pier / Allowable bearing capacity of soil

- Usually the walls and piers are given footing such that the width at the base become to twice the width of wall at the plinth level. By adding width of offsets of concrete the total width of foundation can be obtained for stepped footing.

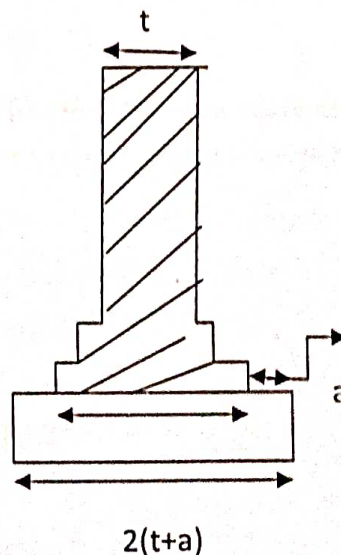
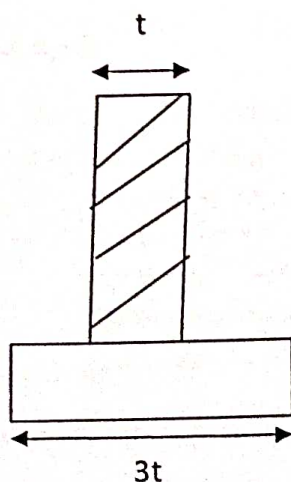

Where t = thickness of wall

a = offset of concrete

Then width of foundation = $2(t+a)$

(ii) Depth of foundation:-

- As a general rule, all the shallow foundations should be taken to a minimum depth of 800mm below natural ground level unless hard soil is available within 800mm.
- The total load to be transferred to the soil per square metre can be worked out and after the study of the results of the trial pits, the foundations should be taken to such a depth at which the soil has allowable bearing capacity greater than this value.
- The depth of foundation can also be obtained by drawing the lines of angles 45° and 60° as shown in figure...

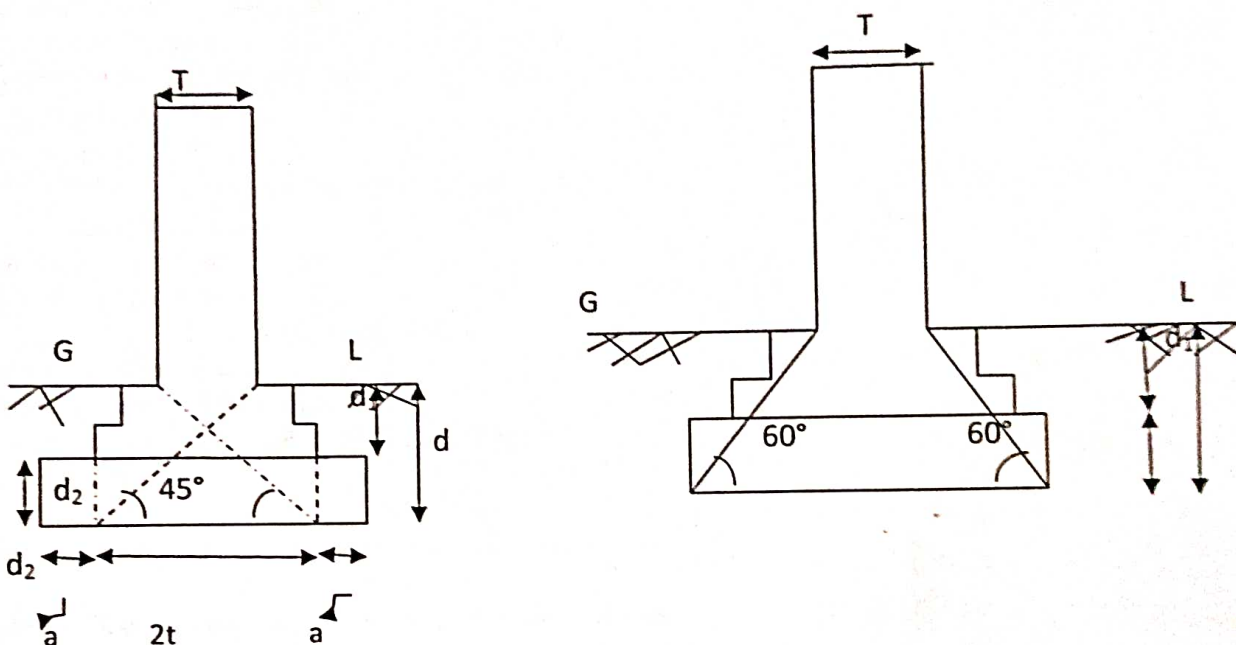

Let d_1 = Depth of footings

d_2 = Depth of concrete block

d = Total depth of foundations

Then $d = d_1 + d_2$

- For loose soil, Rankin's formula, can be used to find the minimum depth of foundations.
- For loose soil Rankin's formula can be used to find the minimum depth of foundation.

$$\text{Rankin's formula } (d) = \frac{p}{w} \left\{ \frac{1 - \sin \phi}{1 + \sin \phi} \right\}^2$$

Where d = minimum depth of foundation in meters

w = weight of soil in Kg/m^3

ϕ = Angle of repose

p = Load of soil in Kg/m^2

For finding out the depth of concrete block, the following formula can be used

- Depth of concrete block = $\frac{1}{58} \sqrt{p \text{al/m}}$
- Depth of concrete block = $\frac{5}{6} t$

Where p = total load on foundation bed Kg/m^2

a = offsets of concrete in cm

m = safe modulus of structure in kg/cm^2

t = thickness of wall in cm above plinth level.

Problem-1

A brick pier $600\text{mm} \times 600\text{mm}$ is 4m high it has to carry an axial load of 520KN . The allowable bearing capacity of soil on which the pier is to rest is 250KN/m^2 . The weight of brick masonry is 18.84KN/m^3 . The angle of repose is 30° and the weight of earth is 16KN/m^3 . Design a suitable foundation for pier.

Solution:-

Width of the foundation:-

Load on pier = $0.6 \times 0.6 \times 0.4 \times 18.84 = 27.13\text{KN}$

Total load on foundation = $520 + 27.13 + 52.87 = 600\text{KN}$

Area of base foundation = $600/250 = 2.4\text{m}^2$

Side of base = $\sqrt{2.4} = 1.55\text{m}$

Provided area = $(1.6 \times 1.6)\text{m}$

Width of footing on top of concrete = $(2 \times 0.6) = 1.2\text{m}$

Offset of concrete = 0.2m

Total width = $1.2 + 2 \times 0.2 = 1.6\text{m}$

Depth of foundation = $d = 3/2 t$

$$= 3/2 \times 0.6 = 0.9\text{m}$$

By use Rankin's formula

$$d = p/w \left\{ \frac{1 - \sin \phi}{1 + \sin \phi} \right\}^2$$

Load on soil (p) = $600 / (1.6 \times 1.6) = 234.37\text{KN/m}^2$

$w = 16\text{KN/m}^3$

$\phi = 30^\circ$

Depth of foundation (d) = $234.37/16 \left\{ \frac{1 - \sin 30^\circ}{1 + \sin 30^\circ} \right\}^2$

$$= 1.62\text{m} = 1.7\text{m}$$

Depth of concrete block = $5/6 \times 0.6 = 0.5\text{m} = 500\text{mm}$

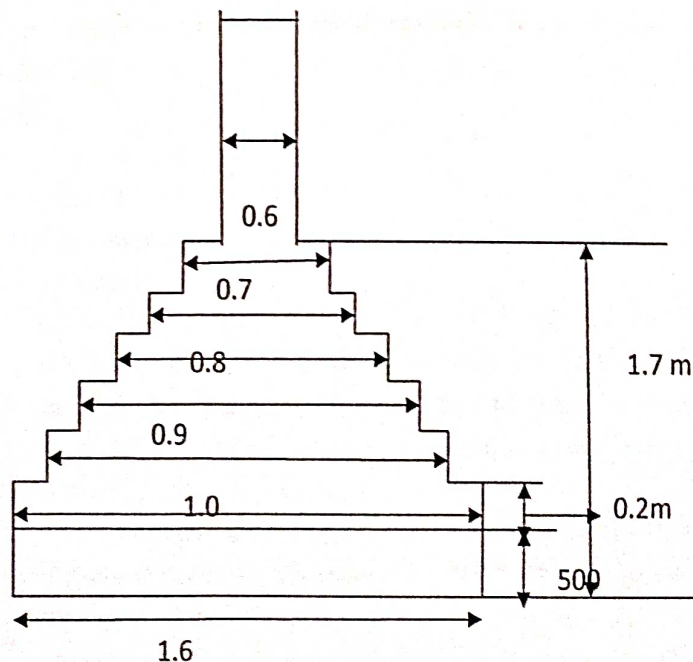

Chapter-4 WALLS

Topics to be covered:

- Purpose of walls
- Classification of walls
- Classification of walls as per materials of construction
- Brick masonry: definition of terms
- Bond- meaning and necessity: English bond for 1, 1-1 $\frac{1}{2}$ and 2 brick thick walls
- T, X and right angled corner junctions
- Construction of brick walls- method of laying bricks in walls, precautions observed in construction of walls
- Construction, expansion and contraction joints; purpose and constructional details
- Stone masonry: definition of terms
- Types of stone masonry
- Partition walls: constructional details, suitability and uses of brick and wooden partition walls
- Mortars- preparation, use, average strength and suitability of mason's brick layer and tubular scaffolding
- Shoring and underpinning: types and uses
- Safety in construction of low and high rise building

Purpose of wall:-

- Wall is one of most essential, component of a building.
- The primary function of a wall is to enclose or divide spaces of the building to make it more functional and useful.
- Walls provide privacy and gives protection against heat, sun, rain, cold.
- Walls provide support to floors & roofs.
- Walls should be designed as to have provision of the following adequate.
 - i. Strength & stability
 - ii. Durability
 - iii. Weather resistance
 - iv. Fire resistance
 - v. Thermal insulation
 - vi. Sound insulation

Types of walls: - A wall may be classified as bearing and non-load bearing.

- i. Load bearing wall:- a load bearing wall is a wall that bears a load resting upon it by conducting its weight to a foundation structure. The materials most often used to construct load-bearing wall in large building are concrete, block or brick.
- ii. Non-load bearing wall:- Non-load bearing walls are those which are designed to carry only own load. They generally serve as divide walks or partition walls.
- iii. Retaining walls:- A retaining wall is constructed to retain the artificial filling.

Brick masonry:-

Definition of terms:-Mortar:-The mortar is required to keep the stones in position. It is prepared by mixing lime or cement with sand and after adding water it is placed in the joints. The type of mortar to be used will depend on the strength required. The usual varieties are lime mortar, cement, mortar etc.

Classification of walls as per materials of construction:

Brick: A brick is a block or a single unit of a kneaded clay – bearing soil, sand and lime or concrete material, fire hardened or air dried used in masonry.

Reinforce concrete: Reinforce concrete is a composite material in which concrete's relatively low tensile strength & ductility are constructional by inclusion of reinforcement having higher tensile strength and/or ductility.

Composite masonry: Sometimes the facing and backing of a wall are constructed with different classes of masonry or different materials. This is known as the composite masonry.

Precast concrete: Precast concrete is a construction product produced by casting concrete in a reusable mold or form which is then cured in a controlled environment, transported to the construction site and lifted into place.

Solid concrete blocks: solid concrete blocks of size 400mm × 200mm × 150 mm are commonly manufactured. The blocks should satisfy the strength requirement of 4 N/mm². The density should be as low as possible, so that handling is not difficult. These block need less mixes.

Hollow concrete blocks: Hollow concrete blocks of size 400mm × 200mm × 190 mm are commonly manufactured. These blocks need richer mixes. Fine aggregates up to 60% & coarse aggregates up to 40% are used less in weight.

Masonry: the term masonry is used to indicate the art of building the structures in either stones or bricks.

- Stone masonry
- Brice masonry

Stretcher:-This is a brick laid with its length parallel to the face or front or direction of a wall. The course containing stretchers is called stretcher course.

Header:-This is a brick laid with its breadth or width parallel to the face or front or direction of a wall. The course containing header is called header course.

Frog:-A frog is a mark of depth about 10mm to 20mm which is placed on the face of a brick to form a key for holding the mortar.

Quoin:-A brick which is cut such that an angle other than a right angle is formed in plan is known as squint quoin.

Closer:-A piece of brick which is used to close up the bond at the end of brick course is known as closer.

Queen closer:-This is obtained by cutting the brick longitudinally in two equal parts.

King closer:-This is obtained by cutting a triangular portion brick such that half of a header & half of a stretcher are obtained on the adjoining act faces.

Bed:- The lower surface of the brick when laid flat is known as bed.

Jambs:-The vertical sides of the opening which are left in walls to receive door, windows etc are known as the jambs.

Heating:-In winter it becomes necessary to supply slightly heated air to the inside of the building. This will also compensate head loss from the room.

Facing:-The material which is used in the face of the wall is known as facing.

Face:-The surface of wall exposed to the weather is known as the face.

Back:-The inner surface of wall which is not exposed to the weather is known as the back.

Backing: - The material used in the formation of the back of the wall is known as the backing.

Hearting: - The portion of wall between facing and backing is known as the hearting.

Plinth:-The projecting course at ground floor level is known as the plinth.

Soffit:-This is the inner surface of the arch.

Reveals: - The exposed vertical surfaces at right angles to the door or window frames are known as the reveals.

Bond: - A bond is arrangement of layer of stones or bricks by which no continuous vertical joints are formed.

Types of bond:

The various types of bond with their patented names have been constructed. Following are the types of bonds in brickwork:

1. Stretcher bond
2. Header bond
3. English bond
4. Flemish bond
5. Garden wall bond
6. Raking bond
7. Dutch bond
8. Brick on edge bond
9. English cross bond
10. Facing bond

Stretcher bond: In this type of bond, all the bricks are arranged in the stretcher courses. The stretcher bond is useful for one- brick partition walls as there are no headers in such walls. As this bond not develop proper internal bond, it should not be used for walls having thickness greater than that of one- brick wall.

Header bond: in this type of bond, all the bricks are arranged in header course. This type of bond is use only when the thickness of the wall is equal to one brick i.e. 19 cm. it is achieved by using three- quarter brick bats in each alternate course as quoins. This bond does not have strength to transmit pressure in the direction of the length of the wall. Hence it is not suitable for load bearing walls.

English bond: this is most commonly used bond for all type of walls. It is considered as the strongest bond in brickwork. The alternate course consists of stretcher and headers. Each alternate header is centrally supported over a structure.

Flemish bond: in this type of bond is created by alternatively laying header & stretchers in a single course. The next course is laid so that a header lies in the middle of the stretcher lies in the middle of the stretcher course below.

These are of two types.

1. Double Flemish bond
2. Single Flemish bond

THE FIGURE OF FLEMISH BOND:

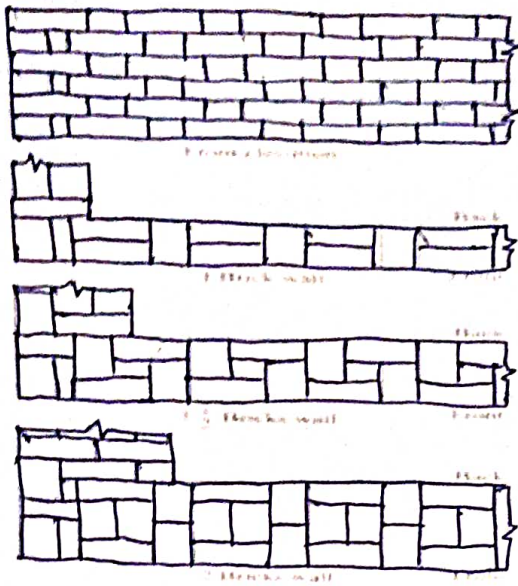

Junctions: A connection between a main wall and a partition wall is termed as a junction. Following points should be kept in view while providing a junction:

- i. The header course of the cross wall enters the stretcher course of the main wall.
- ii. The alternate course of the cross wall are simply touching the main wall.

A junction is classified in two categories:

- i. Right- angled junction
- ii. Squint junction

1. Right- angled junction :

This type of junction has two forms:

- a) Tee- junction
- b) Cross- junction or intersection

Tee junction:

This type of right-angled junction forms the shape of the English letter T in plan.

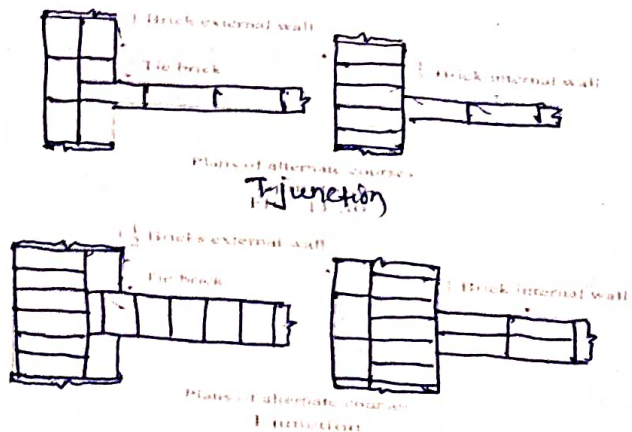

Cross junction or intersection: When two continuous walls cross or intersect each other.

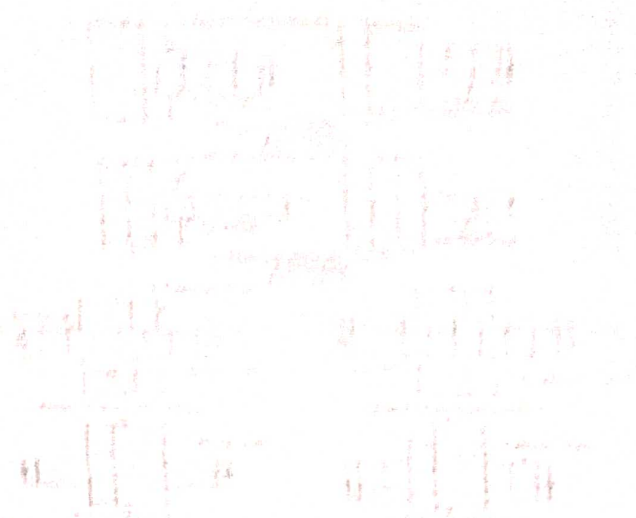

Squint junction: A Squint junction is formed when two walls meet each other at an angle other than a right without making a quoin. It may be in the English bond or Flemish bond. The squint junction is however not common in brickwork and it is rarely adopted because great difficulty is experienced in accurately forming it in practice.

Expansion joints: the provision horizontal and vertical expansion joints in wall helps in reducing the crack to a considerable extent. The horizontal expansion joints absorb vertical movement and vertical expansion joints absorb horizontal movement. An expansion joints is considered necessary in brick walls its length exceed 15m and they are usually provided in long walls at offsets or junction and near corners.

Stone masonry:

- **Natural bed:** The building stones are obtained from rocks. These rocks have a distinct plane of division along the stones can easily be split. This plane represents the natural bed.
- **String course:** The horizontal courses provided at suitable levels between the plinth and the cornice is termed as a string course.
- **Corbel:** A corbel is a projection stone which is usually provided to serve as support for roof truss, beam, and weather shed etc.

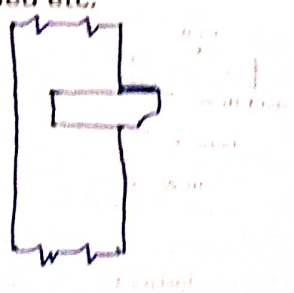

- **Cornice:** A cornice is a course of stone provided at the top of the wall.

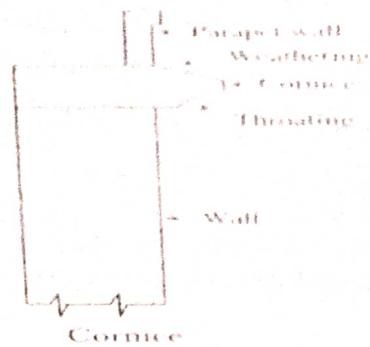

- **Coping:** A coping is a course of stone which is laid at the top wall so as to protect the wall from rain water.

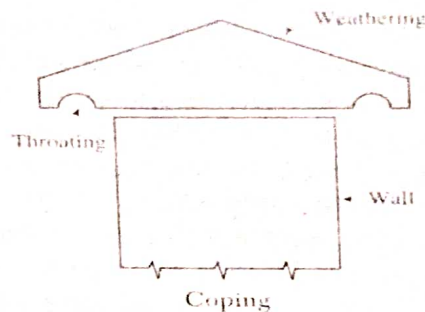

- **Throating:** A groove is provided on the underside of sill, cornice and coping so that the rain water can be discharged clear of the wall surface. This is known as throating.
- **Through stone:** In stone work some stones at regular intervals are placed right across the wall such stones are known as the through stones.
- **Parapet:** It is the portion of low height wall constructed along the edge of the roof to protect the users.
- **Pilaster:** A right angled columnar projection from a wall or a pier is known as a pilaster.
- **Buttress:** A buttress is a sloping or a stepped pier and it is provided to work as lateral support to the wall.
- **Template:** A bedding block is generally provided at the end of a truss. This block is known as a template. A template may be of wood or stone or R.C.C.
- **Moulding:** this is a term which is used to indicate the process of formation of moulded sections. It can be done either by hand or by machine.
- **Bedding planes:** It is the line separating one layer of compressed rock from the next layer of compressed rock.

Types of stone masonry:

The stone masonry is classified under two categories.

- Rubble masonry
- Ashlar masonry

Rubble masonry: the stone masonry in which either undressed or roughly dressed stone are laid in a suitable mortar is called rubble masonry. In this masonry the joints are not of uniform thickness.

- Coursed masonry

- ii. Un Coursed masonry
- iii. Random masonry
- iv. Dry masonry
- v. Polygon masonry
- vi. Flint masonry

- I. **Random masonry:** the random masonry in which either undressed or hammer dressed stone are used, that is called random masonry. Further random rubble masonry is also divided into the following types:
 - **Uncoursed Random masonry:** The Random rubble masonry in which stones are laid without forming courses is known as Uncoursed Random masonry. The stones are used in the masonry are of different sizes and shapes.
 - **Suitability:** Used for construction of walls of low height in case of ordinary buildings.
2. **Coursed random rubble masonry:** The random rubble masonry in which stones are laid in layers of equal height is called coursed random rubble masonry.
 - **Suitability:** Used for construction of walls of low height in case of ordinary building.
- II. **Coursed masonry:** In this type of rubble masonry the height of stones vary from 50mm to 200 mm. The stones are sorted out before the work commences. The masonry work is then carried out in courses are of equal heights. This type of masonry is used for the construction of public buildings, residential buildings etc.
 - **Ashlar masonry:** The stone masonry in which finely dressed stones are laid in cement or lime mortar is known as Ashlar masonry. This type of masonry is much costly as it requires dressing of stone.
 - **Suitability:** This masonry is used for heavy structures, architectural buildings, etc.
 - i. **Ashlar fine:** In this type of stone masonry stone blocks of same height in each course are used. Every stone is fine tooled on all sides. It is an expensive type of stone masonry as it requires heavy labor and wastage of material while dressing.
 - ii. **Ashlar facing:** Ashlar facing is the best type of ashlar masonry. Since this type of masonry is very expensive, it is not commonly used throughout the whole thickness of the wall, except in works of great importance strength.
 - iii. **Ashlar rough masonry:** In this type ashlar masonry, the beds and sides are finely chisel dressed. But the face is made by mean of chisel, is proved around the perimeter of every stone exposed for view. The thickness of the mortar joints does not exceed 6 mm.
 - **Sections for coursed rubble masonry:**
Stone shall be hard sound, free from decay and weathering. Stones with porous matter or with bolder skin shall be rejected. The size of stones shall not be less than 15 cm in any direction. Cement and sand for cement mortar or lime mortar shall be of standard specification.

Partition walls:

A dividing or a screen wall which is constructed inside the enclosed area is known as a partition and it can be constructed either on ground floor or upper floors.

Types of partitions:

Following are the usual types of partitions:

1. Brick partitions
2. Clay block partitions
3. Concrete partitions
4. Glass partitions
5. Timber partitions
6. Metal partitions
7. Plaster slab partitions
8. Asbestos cement sheet partitions
9. Wood wool slab partitions
10. Strawboard partitions

1. Brick partitions

The half-brick partitions are very common and they may be plain, reinforced. The plain brick partitions of half-brick thickness can not take heavy load and their height is restricted to about 2 meters or so.

The reinforced brick partitions of half-brick thickness are more durable and possess more strength.

Following points should be noted:

- i. The brickwork should be carried out in cement mortar of proportion 1:3.
- ii. The surfaces of timber framework coming in contact with the masonry should be coated with coal tar.
- iii. The brickwork should be well-watered before plastering of the surface commences.

2. Clay block partitions:

The blocks are prepared from clay or terra-cotta and they may be either solid or hollow. The blocks are usually of section 300 mm × 200 mm and the thickness of hollow blocks varies from 50 mm to 150 mm. The blocks are provided with grooves on top, bottom and sides. They are light in weight and are non-shrinkable.

3. Concrete partitions:

It is possible to construct partitions of concrete which may be either pre-cast or cast-in-situ. In case of pre-cast concrete work, the concrete slabs of suitable sizes are prepared and they are secured to pre-cast posts.

4. Glass partitions:

In this type of partitions, the glass is used either in the form of sheets or hollow blocks. A timber framework is prepared and the sheets of glass are inserted in the panels. The sheets of glass are kept in position in panels by applying putty which is a mixture of linseed oil and whiting chalk.

5. Timber partition:

In this type of partitions, the wooden framework is properly supported on floor and fixed to the side walls. The framework which consists of horizontal and vertical members can either be plastered or covered with boards, etc. from both the sides.

6. Metal partitions:

It is possible to use metals for forming partitions. The mild steel and bronze are the common metals used for this purpose. The vertical posts of mild steel are erected and then panels are formed by fixing sheets of mild steel or bronze. The hollow spaces may be filled with some good insulating material.

7. Plaster slab partitions:

A number of varieties of plaster slabs or boards are available in the market under different trade names. They are generally made of burnt gypsum or plaster of Paris and in order to reduce their density, the sawdust or some such fibrous material is added. The plaster slabs are prepared in moulds which may be of iron or wood.

8. Asbestos cement sheet partitions:

It is possible to use the asbestos cement sheet for forming partitions. A framework of wood is prepared and the asbestos cement sheets, suitably cut, are fixed either to one side or to both the sides of the frame. These partitions are light in weight, durable, impervious to water, economical and fire-resistant.

9. Wood wool slab partitions:

These slabs are prepared from a mixture of Portland cement and wood wool or wood shavings. A small quantity of gypsum is sometimes added. The partitions of these slabs have sufficient heat and sound insulating properties. The slabs are available in the market under different trade names.

10. Strawboard partitions:

In this type of partitions, the slabs prepared from compressed straw and covered with thick paper or hardboard is used. These slabs possess good heat and sound insulation and the partitions of these slabs can be easily constructed. The partitions of strawboard are useful at places where frequent removal of partitions is anticipated.

Preparation of mortars:

For preparing mortar the water is added to an intimate mixture of binding material and sand. The water should be free from clay, earth and other impurities. The water which is fit for drinking should only be used for preparing mortar. The different mortars are the following ways:

i. Lime mortar:

The lime mortar is prepared either by prepared either by pounding or grinding. The pounding is adopted for preparing small quantities of mortar. The grinding is adopted for preparing large quantities of mortar and to ensure a steady and continuous supply of mortar.

Pounding: In this method, the piles are formed in hard ground and they are provided with lining of bricks or stones at their sides and bottom.

Grinding: in this method, the grinding mills are used to prepare mortar.

ii. Surkhi mortar:

The mix of fat lime and surkhi or fan lime, surkhi and sand is decided and it is converted into a good paste by grinding in a mortar mill or by pounding.

iii. Cement mortar:

This mortar does not require pounding or grinding. The cement and sand are mixed in required proportions in dry state on a watertight platform or steel through. The mixing in dry state is done twice or thrice. The water is then added and the ingredients are again thoroughly mixed.

iv. Gauged mortar:

The required quantity of cement is then added and the ingredients are thoroughly turned up and down to cause intimate mixing.

Use of mortar:

Following are the uses of mortar:

1. To bind the building units such as bricks, stones etc. into a solid mass.
2. To carry out pointing and plaster work on exposed surfaces of masonry.
3. To form an even and soft bedding layer for building units,
4. To form joints of pipes,
5. To improve the general appearance of structure
6. To prepare moulds for coping, corbels, cornice etc
7. To serve as a matrix or cavity to hold coarse aggregates etc.
8. To hide the open joints or brickwork and stonework.
9. To fill up the cracks detached in the structure during maintenance process etc.

Scaffolding:

When the height of wall or column or other structural member of a building exceeds about 1.5 m, temporary structures are needed to support the platform over which the workmen can sit and carry on the constructions. These temporary structures, constructed very close to the wall, are in the form of timber or steel framework, commonly called scaffolding.

Component parts:

Scaffolding has the following components:

- i. **Standards:** These are the vertical members of the frame-work, supported on the ground or drums, or embedded into the ground.
- ii. **Ledgers:** These are horizontal members, running parallel to the wall.
- iii. **Braces:** These are diagonal members fixed on standards.
- iv. **Putlogs:** These are transverse members, placed at right angles to the wall with one end supported on ledgers and other end on the wall.
- v. **Transoms:** These are those putlogs whose both ends are supported on ledgers.
- vi. **Bridle:** This is a member used to bridge a wall opening; supports one end of putlog at the opening.
- vii. **Boarding:** These are horizontal platform to support workmen and materials; these are supported on the putlogs.
- viii. **Guard rail:** This is a rail, provided like a ledger, at the working level.
- ix. **Toe board:** These are boards, placed parallel to ledgers, and supported on putlogs, to give protection at the level of working platform.

FIGURE OF SCAFFOLDING:

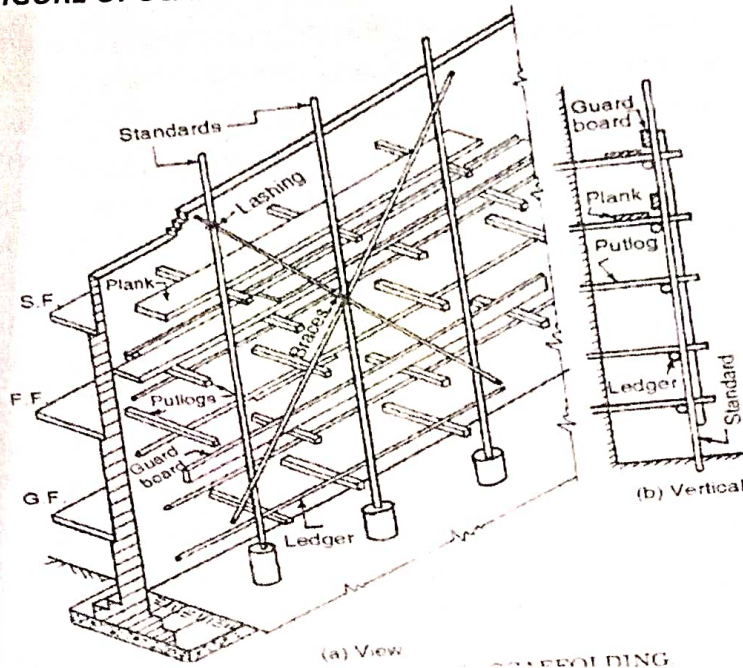

Types of scaffolding:

Scaffoldings can be of the following types:

- i. Single scaffolding or brick-layers scaffolding
- ii. Double scaffolding or masons scaffolding
- iii. Cantilever or needle scaffolding
- iv. Suspended scaffolding
- v. Trestle scaffolding
- vi. Steel scaffolding
- vii. Patented scaffolding

i. Single scaffolding or brick-layers scaffolding:

This consists of a single frame work of standards, ledgers, and putlogs etc., constructed parallel to the wall at a distance of about 1.20 meters. The standards are placed at 2 to 2.5 m interval. Ledgers connect the standards, and are provided at a vertical interval of 1.2 to 1.5 m. putlogs are placed with one end on the ledgers and other end on the ledgers and other end in the hole left in the wall, at an interval of 1.2 to 1.5m such a scaffolding is commonly used for brick laying, and is also called putlog scaffolding.

ii. Double scaffolding or masons scaffolding:

In stone masonry, it is very difficult to provide holes in the wall to support putlogs. In that case a more strong scaffolding. Each row thus forms a separate vertical frame work. The first row is placed at 20 to 30cm away from the wall while the other frame work is placed at 1 m distance from the first one. Putlogs are then supported on both the frames.

iii. Cantilever or needle scaffolding:

Cantilever scaffolding is used under the following circumstances:

- a) Ground is weak to support standards.
- b) Construction of upper part of the wall is to be carried out.
- c) It is required to keep the ground, near wall, free for traffic etc.

iv. Suspended scaffolding:

This is a light weight scaffolding used for repair works such as pointing painting etc. the working platform is suspended from roofs by mean of wire ropes or chains etc. The platform can be raised or lowered at any desire level.

v. Trestle scaffolding:

Such type of scaffolding is used for painting and repair works inside the room, up to a height of 5 m. The working platform is supported on the top of movable contrivances such as tripods, ladders etc. mounted on wheels.

vi. Steel scaffolding:

Steel scaffolding is practically similar to timber scaffolding except that wooden members are replaced by steel tubes and rope lashings are replace d by steel couplets or fittings. Such scaffolding can be erected and dismantled rapidly.

vii. Patented scaffolding:

Many patented scaffolding, made of steel, are available in the market. These scaffoldings are equipped with special couplings, frames etc. The working platform is supported on brackets which can be adjusted at any suitable height.

Shoring:

Sometimes the structures are to be temporarily supported. This is achieved by what is known as the shoring.

FIGURE OF SHORING:

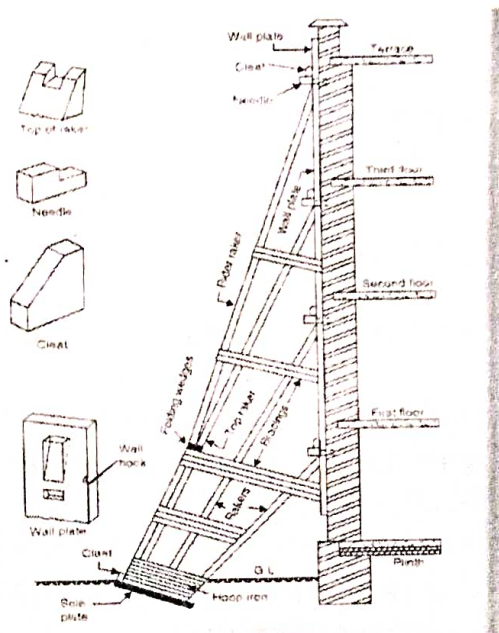

Types of shoring:

Depending upon their supporting characteristics, the shores are classified into the following three categories:

1. Ranking or inclined shores
2. Flying or horizontal shores
3. Dead or vertical shores

Ranking or inclined shores:

In this arrangement, the inclined supports are given to the external walls from the ground. A ranking shore consists of wall plate, needles, cleats, rackers, bracing and sole plate. The wall plate is placed against the wall and is secured by means of needles which penetrate in to the

wall for a distance of about 150 mm. the wall plate distributes the pressure evenly. The needles, in turn, are secured by cleats which are nailed to the wall plate. The rakers are interconnected by struts or braces or lacing. They are connected with the sole plate by means of iron dogs.

Flying or horizontal shores:

In this arrangement, the horizontal supports are given to parallel walls which have become unsafe due to the removal or collapse of the intermediate building. A single flying shore consists of wall plate, needles, cleats, struts, straining pieces and folding wedge. The flying shore should have a depth not less than one-thirtieth of the clear span and width not less than one-fiftieth of its length.

Dead or vertical shores:

In this arrangement, the horizontal members, known as the needles are supported by vertical members known as the dead shores. The needles are driven at right angles to the wall through the holes made in the wall. A dead shore is used under the following circumstances:

- i. The lower part of the wall has become defective.
- ii. The foundations are to be deepened.
- iii. The lower part of the wall is to be rebuilt or reconstructed.
- iv. The large openings are to be in the existing wall.

Underpinning:

the placing of new foundation below an existing foundation or the process of strengthening the existing foundation is known as the underpinning of foundations.

Methods of underpinning:

Following are the methods of underpinning:

- i. Pit method
- ii. Pile method
- iii. Miscellaneous methods

Pit method:

In this method, the existing wall is divided into suitable sections of width about 1.20 m to 1.50 m.

The holes are then made in the existing wall. The needles with bearing plates are then inserted through these holes and supported on jacks and supported on jacks. The pit is excavated and the existing foundation is taken up to the required level. Following precautions are necessary:

- i. One section should be excavated at a time.
- ii. The alternate section should be taken in succession.
- iii. If the length of wall is more, the underpinning is started from the middle and it is then extended in both the direction.
- iv. The proper timbering should be provided for the trench.
- v. It is desirable to carry out the new foundation work in concrete.
- vi. If space to support needles on outside is not available the cantilever needles projecting inside and provided with fulcrums and loading may be adopted.

Pile method:

In this method, the piles are driven along both the sides of the existing wall and then needles in the form of piles caps are provided through the existing wall as shown in fig .

Thus the existing wall is relieved of the loads coming on it.

This method is useful in clayey soils and for water-logged areas and form walls carrying heavy loads.

Miscellaneous methods

Following are some of the specialized underpinning methods which may sometimes be successfully aborted:

1. Cement grouting
2. chemical consolidation
3. freezing
4. vibrofloatation

Each of the above method will now briefly describe.

1. Cement grouting:

This method is used to restore slab or pavement which has settled. The operation is simple. The holes are drilled in the slab and the cement grout is forced under pressure through these holes.

2. Chemical consolidation:

In this method, the soil under the existing footing is consolidated by using chemicals. This method is useful when the soil consists of sand or granular materials and the cost of consolidation depends on nature of soil, depth of consolidation, site work, etc.

3. Freezing:

In this method, the freezing pipes are driven below the existing footing and the soil is frozen. This method is rarely adopted, mainly because of two reasons:

- i. It is expensive and
- ii. More time is required for the installation of freezing pipes.

4. Vibrofloatation:

In this method, the underpinning is carried out by vibrating the sand and thereby increasing its density which ultimately results in the increase of bearing capacity of soil. This method is useful for granular or sandy soil and before the process of underpinning starts, the building or any of its structural components is shored carefully.

.....**THE END**.....

CHAPTER-5

Damp proofing

Topics to be covered:

- *Dampness and its ill effects on bricks, plaster, wooden fixtures, metals fixtures and reinforcement, damage to aesthetic appearance, damage to heat insulating materials, damage to stored articles and healthy, sources and caused of dampness*
- *Types of dampness*
- *Moisture entrapped during construction i.e. moisture in concrete, masonry construction and plastering work etc.*
- *Damp proofing materials and their sections*
- *Methods of damp proofing basement, ground floors plinth and walls etc.*

One of the basic requirements of a building is that it should remain dry or free from moisture travelling through walls, roofs or floors. Dampness is the presence of hygroscopic or gravitational moisture. Dampness gives rise to hygienic conditions, apart from reduction in strength of structural components of the building. Damp prevention is therefore one of the important items of building design. Every building should be damp proof. Provision of damp proof course prevents the entry of moisture in the building.

Following are various causes of dampness in building:

1. Moisture rising up the walls from ground
2. Rain travel from wall tops
3. Rain beating against external walls
4. Condensation

Effects of dampness:

The following are the ill effects of entry of dampness:

1. Dampness gives rise to breeding of mosquitoes and create unhealthy living conditions.
2. Travel of moisture through walls and ceiling may cause unsightly patches.
3. Moisture travel may cause softening and crumbling of plaster, specially lime plaster.
4. The wall decoration is damaged, which is very difficult and costly to repair.
5. Continuous presence of moisture in the wall may cause efflorescence resulting in disinfection of bricks, stones, tiles etc.
6. The flooring gets loosened.
7. Timber fittings, such as doors, windows, almirahs etc., coming in contact with damp walls, damp floors etc., get deteriorated.

8. Electrical fittings get deteriorated, giving rise to leakage of electricity and causing short circuiting.
9. Floor coverings are damaged.
10. Moisture causes rusting and corrosion of metal fittings attached to walls, floors and ceilings.

Methods of damp proofing:

Following methods are adopted to make a building damp proof:

1. Use of damp proofing course (D.P.C) : membrane damp proofing
2. Integral damp proofing
3. Surface treatment
4. Cavity wall construction
5. Guniting
6. Pressure grouting.

1. Use of damp proofing course (D.P.C) : membrane damp proofing:

This consists of introducing a water repellent membrane or damp proof course between the source of dampness and the part of building adjacent to it. Damp proofing course may consist of flexible materials such as bitumen, mastic asphalt, bituminous felts, metal sheets, cement concrete etc.

2. Integral damp proofing:

This consists of adding certain water proofing compounds of materials to the concrete mix, so that it becomes impermeable.

3. Surface treatment:

The surface treatment consists of application of layer of water repellent substances or compounds on these surfaces through which moisture enters. The use of water repellent metallic soaps such as calcium and aluminum oletes and stearates are much effective against rain water penetration. Pointing and plastering of the exposed surfaces must be done carefully, using water proofing against like sodium or potassium silicates, aluminum or zinc sulphates and magnesium sulphates etc.

4. Cavity wall construction:

This is an effective method of damp prevention, in which the main wall of a building is shielded by an outer skin wall, leaving a cavity between the two.

5. Guniting:

This consists of depositing under pressure, an impervious layer of rich cement mortar over the exposed surfaces for water proofing or over pipes, cisterns etc. for resisting the water pressure. Cement mortar consists of 1:3 cement sand mix, which is shot on the cleaned surface with the help of a

cement gun, under a pressure of 2 to 3 kg/cm². The nozzle of the machine is kept at a distance about 75 to 90 cm from the surface to be get an impervious layer. The layer should be properly cured at least for 10 days.

6. **Pressure grouting:**

This consists of forcing cement grout, under pressure, into cracks, voids, fissures etc. present in the structural components of the building, or in the ground. Thus the structural components and the foundations which are liable to moisture penetration are consolidated.

Materials used for damp proofing course:

1. The material should be perfectly impervious.
2. The materials should be durable.
3. The materials should be strong, capable of resisting super-imposed loads/pressure the building.
4. The materials should be such that leak-proof jointing is possible.
5. The materials should not be costly.

Following materials are commonly used for damp-proofing course:

i. **Hot bitumen:**

This is highly flexible material which is applied with a minimum thickness of 3 mm. It is placed on the bedding of concrete or mortar, while in hot condition.

ii. **Mastic asphalt:**

Mastic asphalt is semi-rigid material which is quite durable and completely impervious. It is obtained by heating asphalt with sand and mineral fillers. However, it should be laid very carefully, by experienced persons.

iii. **Bituminous or asphaltic felts:**

This is a flexible material which is available in rolls of various wall thicknesses. It is laid on a leveled flat layer of cement mortar. An overlap of 10cm is provided at the joints and full width overlap is provided at angles, junctions and crossings.

iv. **Metal sheets:**

Sheets of lead, copper aluminum can be used as D.P.C. These sheets are of flexible type. Lead sheets are quite flexible. Their thickness should be such that its weight is not less than 20 kg/m². They are laid similar to the bituminous felts. Lead sheets have the advantages of being completely impervious to moisture, resistant to ordinary atmospheric corrosion and resistant to sliding action.

Copper sheet, of minimum 3 mm thickness, are embedded in lime or cement mortar. It has high durability, high resistance to dampness, and high resistance to sliding and reasonable resistance to ordinary pressure. Aluminum sheets, if used, should be protected with a layer of bitumen. It is not as good as lead or copper sheets.

v. **Combination of sheets and bituminous felts:**

Lead foil sandwiched between asphaltic or bituminous felts can be effectively used as D.P.C. The combination, known as lead core possesses characteristics of easy laying, durability, efficiency, economy and resistance to cracking.

vi. **Bricks:**

Special bricks, having water absorption not less than $4\frac{1}{2}$ % of their weight may be used as D.P.C. in locations where damp is not excessive. These bricks are laid in two to four courses in cement mortar. The joints of bricks are kept open.

vii. **Stones:**

Dense and sound such as granite, trap, slates, etc. are laid in cement mortar (1:3) in two courses or layers to form effective D.P.C. The stones should extend to the full width of the wall.

viii. **Mortar:**

Cement mortar (1:3) is used as bedding layer for housing other D.P.C. materials. A small quantity of lime may be added to increase workability of the mortar.

ix. **Cement concrete:**

Cement concrete of 1:2:4 mix or $1:1\frac{1}{2}:3$ mixes is generally provided at plinth level to work as D.P.C. The thickness may vary from 4 cm to 15 cm.

x. **Plastic sheets:**

This is relatively a new type D.P.C. materials, made of black polythene, 0.5 to 1 mm thick in usual walling width and roll lengths of 30 m. C.B.R.I. Roorkee has recently suggested a new comprises a 400 gauge thick alkathene laid over 12 mm thick 1:4 cement mortar.

D.P.C TREATMENT IN BUILDINGS:

1. Treatment to foundations against gravitational water:

Foundation may receive water percolating from adjacent ground, and this moisture may rise in the wall. This can be checked by providing air drain parallel to the external wall. The width of air drain may be about 20 to 30

cm. the outer wall of the drain is kept above the ground to check the entry of surface water. A R.C.C. roof slab is provided.

2. *Treatment to basements:*

When basements in damp soils are constructed, three methods may be adopted:

- i. Provision of foundation drains and D.P.C.
- ii. Provision of R.C.C. raft and wall slab
- iii. Asphalt tanking.

a. *Provision of foundation drains and D.P.C.*

When basement rests on soils which are not properly drained, great hydrostatic pressure is exerted and the floor as well as wall receives water continuously oozing out. In such a case it becomes necessary to make a trench all round, up to foundation level and fill it with gravel, coke and other pervious materials. Open jointed drains may be provided to collect the under- ground water. Drainage pipes, embedded in gravel bed, may also be provided before foundation concrete. Horizontal and vertical D.P.C. is provided in wall as well as foundation concrete.

b. *Provision of R.C.C. raft and wall slab*

Where underground water pressure is severe, the drainage system may not solve the problem effectively. Also, constant pumping out water may be costly. In such a case, floor slab as well as walls may be constructed in ridge R.C.C. structure. Horizontal and vertical D.P.C. is also provided.

c. *Asphalt tanking.*

This is adopted when the subsoil water table is not very high. The treatment consists of horizontal D.P.C in the form of asphaltic layer of 30 mm thick in three coats over the entire area of basement floor and then extending it in the form of vertical D.P.C. on the external faces of the basement walls.

3. *Treatment to floors:*

For locations where ground moisture is not present, subsoil is rammed well and a 7.5 to 10 cm thick layer of coarse sand is spread over the entire area under flooring. Alternatively, stone soiling may first be provided and then 7.5 cm to 10 cm thick layer of lean cement concrete may be provided under it.

4. *Treatment to walls:*

For basement walls, a vertical D.P.C. is laid over the external face of walls. This vertical D.P.C. is laid over the base of water – cement plaster grouted

on the external face of the wall. This vertical D.P.C. is further protected by external protective wall of half brick thickness. The vertical D.P.C. should be carried at least up to a level 15 cm above G.L. similarly, horizontal D.P.C. in external wall, extending from the floor, is provided at least 15 cm above G.L.

.....*THE END*.....

CHAPTER -9

ROOFS

TOPICS TO BE COVERED

- **TYPES OF ROOF**
- **CONCEPT & FUNCTION OF FLAT, PITCHED, HIPPED, & ARCHED & CELL ROOFS**
- **GLOSSARY OF TERMS FOR SLOPED ROOFS & FLAT ROOFS**
- **MATERIALS USED FOR DIFFERENT ROOFS**
- **DIFFERENT TYPES OF WEATHER PROOF COURSE**

Roof:-

A roof is defined as the uppermost part of the building, provided as a structural covering, to protect the building from weather (i.e. from rain, sun, wind, etc.)

Requirements of a roof:-

- It should have adequate strength and stability to carry the super-imposed dead & live loads.
- It should effectively protect the building against rain, sun, wind etc.
- It should be water – proof, and should have efficient drainage arrangements.
- It should be fire resistant

Types of Roof:- Roofs may be divided into three categories:-

(i) Pitched or sloping roofs

(ii) Flat roofs or terraced roofs

(iii) Curved roofs

(i) Pitched roofs:- Pitched roofs have sloping top surface. These are suitable in those areas where rain fall / snow fall is very heavy. Broadly, buildings with limited width and simple shape can generally be covered satisfactorily by pitched roofs.

(ii) Flat Roofs:- Flat roofs are considered suitable for buildings in plains or in hot regions, where rainfall is moderate, and where snow fall is not there. Flat roofs are equally applicable to buildings of any shape & size.

(iii) Curved Roof:-

Curved roofs have their top surface curved. Such roofs are provided to give architectural effects. Such roofs include cylindrical and parabolic shells and folded slabs. Such roofs are more suitable for public buildings like libraries, theatres, recreation centres etc.

Glossary of Terms for Pitched Roof:- A roof with sloping surface is known as a pitched roof.

Pitched roofs are of the following types:-

1. Lean to roof
2. Gable roof
3. Hip roof

4. Gambrel roof
5. Mansard or curb roof
6. Deck roof

1. **Lean-to roof:**-This is the simplest type of sloping roof, provided either for a room of small span, or for the veranda. It has slope only one side.

2. **Gable roof:**-This is the common type of sloping roof which slopes in two directions. The two slopes meet at the ridge. At the end face, a vertical triangle is formed.

3. **Hip roof:**-This roof is formed by four sloping surfaces in four directions. At the end faces, sloped triangles are formed.

4. **Gambrel roof:**-This roof, like gable roof, slopes in two directions, but there is a break in each slope, at each end, vertical face is formed.

5. **Mansard roof:**-Mansard roof like a hip roof slopes in the four directions, but each slope has a break. The sloping ends are obtained.

6. **Deck roof:** - A deck roof has slopes in all the four directions, like a hip roof, but a deck or plane surface is formed at the top

Various elements of pitched roof :-

Span:-It is the clear distance between the supports of an arch, beam or roof truss.

Rise:-It is the vertical distance between the top of the ridge and the wall plate.

Pitch:-It is the inclination of the sides of a roof to the horizontal plane. It is expressed either in terms of degrees or as a ratio of rise to span.

Ridge:-It is defined as the apex line of sloping roof. It is thus the apex of the angle formed by the termination of the inclined surfaces at the top of a slope.

Eaves:-The lower edge of the inclined roof surface is called eaves. From the lower edge, the rain water from the roof surface drops down.

Hip:-It is ridge formed by the intersection of two sloping surfaces, where the exterior angle is greater than 180° .

Valley:-when two roof surfaces meet together and formed an internal angle, a valley is formed.

Hipped end:-It is the sloped triangular surfaces formed at the end of a roof.

Verge:-The edge of a gable, running between the eaves and ridge, is known as a verge.

Common rafters or spars:-These are inclined wooden members running from the ridge to the eaves. They are bevelled against the ridge beam at the head, and are fixed to purlins at intermediate point. They support the battens or boarding to support the roof coverings. Depending upon the roof covering material, the rafters are spaced 30 to 45 cm centre to centre.

Purlins:- These are horizontal wooden or steel members, used to support common rafters of a roof when span is large. Purlins are supported on trusses or walls.

Hip rafters:-These are the sloping rafters which form the hip of a sloped roof.

Cleats:-These are short sections of wood or steel (angle iron), which are fixed on the principal rafters of trusses to support the purlins.

Truss:-A roof truss is a frame work, usually of triangles, designed to support the roof covering or ceiling over rooms.

Types of roof covering materials used for pitched roof:-

1. Thatch
2. Ordinary half- round country tiles
3. Shingles
4. Patent tiles
5. Trafford asbestos-cement tiles
6. Eternit slates
7. Corrugated galvanised iron sheets
8. Asbestos cement corrugated sheets
9. Ruberoid

1. Thatch:-This is very light roof covering. But it is combustible, absorbs moisture rapidly and is easily liable to decay. It is unstable against high winds. A bed of matting is prepared to receive the thatch and in order to drain the roof easily; a pitch of 45 degrees is kept. The thatch is used in rural areas because it is the cheapest form of roof covering and it is simple in construction.

2. Ordinary half round country tiles:- These are used for cheap buildings. If tiles are laid in two layers, the roof is known as a double -tiled roof. An overlap of at least 80mm should be provided when these tiles are used. These tiles are liable to break easily and hence they require frequent replacement.

3. Shingles:- The wood shingles are obtained from the well- seasoned timber with lengths varying from 300mm to 380mm and widths varying from 60mm to 250mm. They are laid in a similar fashion as tiles and slates. And this roof covering is found to be useful especially in hilly areas where the wood is easily and cheaply available.

4. Patent tiles:- It is used as a roof covering . The Mangalore tiles are one of the patterns. They are red in colour & made of doubled channelled Basel Mission Mangalore pattern. The special Mangalore tiles are available for ridge. It is found about fifteen Mangalore tiles are required for covering one square metre of roof area.

5. Trafford asbestos – cement tiles: - These are made of cement and asbestos. They possess less corrugation and are laid with laps of 150mm and 100mm at the ends and at the sides respectively.

6. Eternit slates:- These are fire –resisting, light and cool. They are not easily affected by weather. About eight slates are required for covering one square metre of roof area. These slates are available in three colours:-Grey, Black, & Red.

7. Corrugated galvanized iron sheets:- The galvanized iron sheets are prepared by pressing flat wrought –iron plates between rollers with grooves or teeth and then they are galvanized with a coat of zinc. These are commonly known as the G.I. sheets.

- It is economy, productivity, and labour savings.
- It helps to increase strength & rigidity and they permit easy flow of rain water.
- They are costly & do not offer resistance to fire and sound.

8. Asbestos cement corrugated sheets:-

- The cement is mixed with about 15 percent of asbestos fibres and the paste so formed is pressed under rollers with grooves or teeth. Thus the sheet is commonly known as A.C. sheets.
- It is used for factories, workshops, garages, big halls, etc.
- This helps to increase strength and rigidity and they permit the easy flow of rain water.
- They are available under different trade names such as big-six sheets, standard sheets, Trafford sheets, etc.

- They are cheap, fire-resisting, light in weight, strong, tough, and sound-proof, imperious and durable.

9. **Ruberoid**:- This is a light, flexible and water-proof material. This material is not affected by extreme heat or cold & it is not attacked by white ants. This material is available in two colours-----red & slate (grey).

Different types of weather proof course:-

Water proofing on flat roofs:- In a flat roofs water proof made by four methods

1. Finishing
2. Bedding concrete & flooring
3. Mastic asphalt & jute cloth
4. Use of water proofing compounds

1. **Finishing**:- The finishing of roof surface is done at the time laying cement concrete. The finishing of flat roof is carried out in cement mortar of proportion 1:4 i.e. one part of cement to four parts of sand by volume.

2. **Bedding concrete & flooring**:- The concrete may be brick bats lime concrete 1:6:12 or 1:5:10. The thickness of the concrete layer is about 100mm. The surface of the bedding concrete is provided by a suitable flooring such as tiles, terrazzo, Indian patent stone, etc..

3. **Mastic asphalt & jute cloth**:- In this method, a layer of hot mastic asphalt is laid on the roof surface. The jute cloth is spread over this layer. Then one more layer of mastic asphalt is applied, so that the jute cloth is sandwiched between the two layers of mastic asphalt. The sand is then sprinkled over the entire surface of roof.

4. **Use of water-proofing compounds** :- Some of the water-proofing compounds like Pudlo, Impermo, etc. are available in the market and when a such a compound is added to cement, mortar and concrete. The quantity of water-proofing compound to be added is very small, say 2%.

* The water-proof compounds are available in the powder form & they are to be mixed thoroughly with cement by hand before the cement is mixed with aggregate.

Chapter: 11 Surface finishes

Topics to be covered

- *Plastering – classification according to use and finishes like grit finish, roughens, pebble dashed, plain plaster etc, dubbing, proportion of mortars used for different plasters, preparation of mortars, techniques of plastering and curing*
- *Pointing- different types of pointing, mortar used and method of pointing*
- *Painting- preparation and application of paints on wooden, steel and plastered wall surfaces*
- *White washing, colour washing and distempering, application of cement and plastic paints*
- *Commonly used water repellent for exterior surfaces, their names and application*

Plastering:

The plastering is used to describe the thin plastic covering that is applied on the surfaces of walls and ceilings. The plastering removes the unevenness of the surfaces and sometimes the plastering is used to developed decorative effects.

1. Requirements of good plaster:

Following are the qualities of the plastering material so as to turn out good plaster:

- i. It should adhere to the background and should remain adhered during all variation of the climatic changes.
- ii. It should be cheap and economical.
- iii. It should be hard and durable.
- iv. It should possess good workability.

2. Mortar for plastering:

The selection of type of mortar for plaster depends on various factors such as availability materials, atmospheric conditions, durability required, finishing desired, location of the surface, etc. There are mainly three types of mortar which can be used for the process of plastering:

- i. Lime mortar
- ii. Cement mortar
- iii. Water-proof mortar

Lime mortar:

The lime mortar consists of equal volumes of lime and sand, these two materials are carefully ground in a mortar mill. The fat lime is recommended for plaster work because the fat lime contains 75% of CaO and it combines with CO₂ of atmosphere and gives CaCO₃ quickly. Thus, the lime sets quickly, but it imparts low strength and hence, it can be used for plaster work.

Cement mortar:

The cement mortar consists of one part of cement to four parts of clean, coarse and angular river sand by volume. The materials are thoroughly mixed in dry condition before water is added to them. The mixing of materials is done on watertight platform and mortar of one cement bag only prepared at a time and this quantity of mortar is consumed within 30 minutes after adding water.

Water-proof mortar:

This mortar is water –proof and it is prepared by mixing one part of cement, two parts of sand and pulverized alum at the rate of 120 n per m³ of sand. In the water to be used, 0.75 n of soft soap is dissolved per one liter of water and this soap water is then added to the dry mix.

Tools for plastering:

Following tools are generally use4d for plastering works:

- i. Gauging trowel: this is the ordinary trowel and is useful for applying mortar to mouldings, corners, etc. It has a pointed or bull- nosed end.

ii. **Float:** This tool is used to spread the mortar on the surface. It is made of thin tempered steel. It is also known as the laying trowel. The wooden float is known as the skimming float and is used for final or finishing coat of plaster. A float provided with nails projecting by about 3 mm from the surface is known as the devil float and it is used to make zigzag lines on the plastered surface so as to form a key for the subsequent.

iii. **Floating rule:** This tool is used to check the level of the plastered surface between the successive screeds.

iv. **Plumb bob:** This tool is very much useful in forming screeds in the same vertical plane.

v. **Miscellaneous tools:** In addition to the above tools, other tools such as brushes, spirit level, set squares, straight edges, etc. are used for the plastering work.

Methods of plastering:

The plaster may be applied either in one, two or three coats. It is in the cheapest form of construction that plaster is applied in one coat. For works of ordinary nature, the plaster is applied in two coats and for works of superior quality, the plaster is applied in three coats.

Special materials for plastered surfaces:

Following are the usual special materials for plastered surfaces:

1. **Acoustic plaster:** This surface is prepared when it is desired to give acoustical treatment to the hall or room. The plastered surface is provided with minute openings which absorb the sound. The plaster is usually applied in two coats, each having a thickness of 6 mm.
2. **Asbestos-marble plaster:** This is a mixture of finely crushed marble, asbestos and cement. A beautiful marble like finish is obtained by the use of this material.
3. **Barium plaster:** This material is used as a final coat for surfaces of x-ray rooms so as to protect the persons working in and around x-ray rooms. It is essentially made from barium sulphate.
4. **Granite silicon plaster:** This material is quick-setting and highly elastic. It is therefore not liable to crack. It is used for superior type of work.
5. **Gypsum plaster:** When finely ground gypsum is heated at temperature of 160°C to 170°C , it loses about 14.7 per cent of its water content in the form of steam. The resulting product is hemihydrates of calcium sulphate and it is known as first settle plaster or plaster of Paris. When water is added to plaster of Paris, it hardens in three to four minutes. Hence, to extend the setting time, suitable retarders are added to it.

Pointing:

The term pointing is used to denote the finishing of mortar joints of either stone masonry or brick masonry. The joints are raked out to a depth of about 20 mm and then, these spaces are filled up by suitable mortar in the desired shape.

1. Mortar for pointing:

The pointing is generally adopted for the finishing of exposed external walls of a structure. It is cheap in the first coat, but it requires frequent replacement.

The pointing may be carried out either in lime mortar or cement mortar:

The lime mortar consists of equal volumes of lime and sand. These two materials are carefully ground in a mortar mill. The sand to be used for preparing lime mortar should be clean, fine and free from any organic impurities.

The cement mortar consists of equal volumes of cement and sand. The cement should comply with standard requirements and sand should be clean, fine and free from any organic impurities. The materials are thoroughly mixed in dry condition before water is added to them.

2. Method of pointing:

The pointing is carried out as follows:

- i. The mortar of the masonry joints to be covered by pointing is raked out least to a depth of 20mm.
- ii. The dust from the masonry joints is removed by the brushes.
- iii. The surface is then washed with clean water and it is kept wet for a few hours.
- iv. The mortar is then carefully placed in desired shape in these prepared joints.
- v. The finished surface is well-watered for a period of at least 3 days, if lime mortar is used and 10 days, if cement mortar is used.

3. Types of pointing:

The pointing can be carried out in a number of shapes. The choice of a particular type will depend on the nature of masonry and the effect required.

Following are the usual types of pointing:

- i. **Beading pointing:** this type of pointing is formed a steel or iron rod with a concave edge. The beaded pointing is good in appearance. But it is difficult to maintain as it can be easily damaged.
- ii. **Flush pointing:** This type of pointing is formed by removing the excess mortar from the joint. The joint is made flush with the face. This type of joint does not give appearance. But it is durable as it does not provide any space for accumulation of dust, water, etc and hence, it is extensively used.
- iii. **Recessed pointing:** This type of pointing is kept vertical and it is pressed inside the wall surface by a suitable tool to a depth of about 5 mm or more. This pointing gives very good appearance.
- iv. **Rubbed or keyed or grooved pointing:** In this type of pointing, a groove is formed at the center of height by a pointer. This type of pointing gives better appearance and is generally adopted.
- v. **Struck pointing:** In this type of pointing, the face of pointing is kept inclined. This joint disposes water easily. If the lower edge of joint is kept inside the face of masonry, it is known as the overhand struck pointing. But it will not form a satisfactory joint as water will be collected in the joint.
- vi. **Tuck pointing:** In this type of pointing, a groove is formed at the center of joint. The width and depth of groove are respectively 5mm and 3 mm.
- vii. **Vee- pointing:** In this type of pointing, a Vee-shaped groove is formed in the mortar joint.
- viii. **Weather pointing:** In this type of pointing, a projection in the form of a Vee-shaped is formed.

Painting:-

The paints are coating of fluid materials & they are applied over the surface of metal or timber.

Purpose of painting a surface:-

Painting on a surface is carried out for the following purposes.

- ❖ To protect the surface from weathering effect of atmosphere.
- ❖ To prevent decay of wood & corrosion of metal.
- ❖ It is used to give good appearance to the surface.

Characteristics of an ideal paint:-

Following are the characteristics of an ideal paint.

- It should possess a good spreading power.i.e. Maximum area of the surface should be cover with minimum quantity of the paint.
- The paint should be cheap& economical.
- The paint should be such that it can be easily applied on the surface.
- The paint should form hard & durable surfaces.
- The paint should not be affected by weathering action of the atmosphere.
- The paint should possess attractive appearance.
- The paint should not affect health of worker.
- The paint should be such that its colour is maintained for a long period.
- The paint should be such that it dries in a reasonable time not too rapidly.
- The surface coated with paint should not show cracks.

Ingredients of paint:-

The paint consists of following ingredients.

- a) A base
- b) A vehicle
- c) A drier
- d) A colouring pigment
- e) A solvent

a) **A base :-**

A solid substance in a fine state of division is known as paint. It determines the characteristics of paint, & gives durability to the surface which is painted. It reduces the crack formed on drying.

Ex: - white lead, red lead, oxide of iron etc.

b) **A vehicle:-**

The liquid substances which hold the ingredients of paint in liquid solution is known as vehicle. Due to this ingredient, it is possible to spread the paint uniformly on the surface in the form of thin layer.

Ex:- linseed oil, poppy oil, etc.

c) **A drier:-**

The substance which accelerates the process of drying is known as a drier. A drier absorbs oxygen from the air & transfer it to the linseed oil which in turn & get hardens.

Ex:-cobalt, lead. Manganese etc.

d) **A colouring pigment:-**

When a different colour of paint is required, colouring pigment should be added. The pigments are available in the form of fine powder in various colours.

Ex: - natural earth colour such as umbers, iron oxide. & calcined colour such as Indianred, carbon black etc.

e) **A solvent:-**

The function of a solvent is to make the paint thin, so it can be easily applied on the surface.

Ex:-sprit, turpentine etc.

Process of painting:-

The process of painting should be depends upon the nature of surface to be painted. The painting should be carried out on the following surface.

- a) New wood work
- b) Repainting of old wood work
- c) New iron & steel work
- d) Repainting of old iron & steel work

a) **New wood work:-**

4 coats of paint is carried out for new wood work.

Process:-

- The surface of wood work is prepared to receive the paint. The wood should be well seasoned. The surface of wood work is thoroughly cleaned.
- The surface of wood work is then knotted.
- Then priming coat is on the surface of new wood work.
- The process of stopping is then carried out.
- Then under coat & finishing coat are then applied on the surface.
- The extreme care should be taken to see that the finishing coat present smooth surface, so that no brush mark are seen on the finished surface.

b) **Repainting of old wood work:-**

If paint on old wood work has cracked, it is to be removed. The old paint can be removed by applying; a solution containing 2 N of caustic soda to a liter of water is prepared & used to wash the surface. The paint dissolves and the surface become clean.

Then painting should be carried out.

Process:-

- The surface of wood work is prepared to receive the paint. The wood should be well seasoned. The surface of wood work is thoroughly cleaned.
- The surface of wood work is then knotted.
- Then priming coat is on the surface of new wood work.
- The process of stopping is then carried out.
- Then under coat & finishing coat are then applied on the surface.
- The extreme care should be taken to see that the finishing coat present smooth surface, so that no brush mark are seen on the finished surface.

c) **New iron & steel work:-**

The surface of iron or steel work to receive the paint should be free from rust grease etc. The water with caustic soda or lime is used to remove gas & a wire brush is required to remove all the marks from the surface.

- ❖ The cleaned surface is provided with a film of phosphoric acid, to protect the surface from rust.
- ❖ The suitable paint should select for iron & steel surface & then applied.
- ❖ The finishing coat should give a smooth surface & precaution should be taken to avoid the presence of brush mark on the final painted surface.

d) Repainting of old iron & steel work:-

The old surface should be thoroughly cleaned by application of soap water & if grease is present, it should be removed by washing the surface with lime water. After the surface is prepared painting should be carried out.

Process:-

- ❖ The cleaned surface is provided with a film of phosphoric acid, to protect the surface from rust.
- ❖ The suitable paint should select for iron & steel surface & then applied.
- ❖ The finishing coat should give a smooth surface & precaution should be taken to avoid the presence of brush mark on the final painted surface.

Plastered surface:-

For successful application of paint on cement plastered surfaces, the following factors should be carefully considered:

- i. There is considerable amount of moisture in newly constructed wall with cement plaster. It is necessary to allow the moisture content to escape. The actual time required for drying of wall surface will depend on atmospheric conditions and ventilation. But it usually requires about 3 to 6 months for the surface to ready receiving paint.
- ii. The cement plaster is alkaline in nature because lime is liberated during the hydration of cement.
- iii. The defects in cement plastered surfaces develop due to various reasons. Such defects should be removed and the surface should be prepared to receive the paints.
- iv. The spots showing efflorescence should be brushed off and the surface should be watched for few days.
- v. If there are chances for the discolouration of the painted surface, it is necessary to clean the surface and to sterilize it with antiseptic wash. The organisms reasonable for discolouration are algae, mould, and lichen etc.

Distemping:-

A coat provided to the plastered surface to create a smooth surface is known as distemping.

Purpose:-

The main purpose of providing distemper to give smooth surfaces.

Properties of distemper:-

Following are the properties of distemper.

- ❖ They are generally light in colour & they provide a good reflecting coating.
- ❖ They are less durable than oil paints.
- ❖ They exist poor workability.
- ❖ The coats of distemper are thick & they are more brittle.
- ❖ On drying the film of distemper is shrinking, if the surface to receive distemper is weak.
- ❖ They can be applied on brick work, cement plastered surface etc.
- ❖ They prove to unsatisfactory in damp location such as kitchen, bath etc.

Ingredients of distemper:-

The distemper is consists of following ingredients.

- i) A base:-For base, the whiting or chalk is used.
- ii) A carrier:-For carrier water is used.
- iii) A colouring pigment:-when it is required to different colour colouring pigment should be added.
- iv) Size:-

Process of distemping:-

Distemper is applied in the following way.

Procedure:

- Preparation of surface: - the surface to receive distemper is thoroughly rubbed & cleaned.
- Priming coat: - after preparing the surface to receive the coats of distemper, a priming coat is applied & it is allowed to become dry.

- Coats of distemper: - the 1st coat of distemper is then applied on the surface. It should be of a light tint applied with great care. The 2nd coat of distemper is applied after the first coat has dried & become hard.

Application of white washing:-

White washing is carried out in the following way.

- ✓ The fresh lime is mixed thoroughly with sufficient quantity of water in a tub.
- ✓ It is then screened through a clean cloth. The clean gum is dissolved in hot water is then added at the rate of 20 N/m³ of lime. The rice may be used in place of gum.
- ✓ Then the surface to be white wash should be cleaned before the work is started.
- ✓ For white washing walls, which are white washed before, the old white wash should be 1st removed. & repairing to the plastered work is carried out.
- ✓ The white wash is applied with jute brush. Three coats are generally applied each after the previous coat has completely dried.
- ✓ White washing is more used for interior wall surface, & ceilings of house.
- ✓ The process of white washing is sometimes used for exterior wall surfaces.

Application of colour washing:-

- ✓ Colour washing is carried out in the following way.
- ✓ This is prepared by adding colouring pigment to the screened white wash.
- ✓ It should be seen that the colouring pigment is not affected by the lime.
- ✓ Generally, the yellow earth is popular for colour washing.
- ✓ Generally the walls are colour washed & ceilings are white washed.
- ✓ Then the surface to be white wash should be cleaned before the work is started.
- ✓ For colour washing walls, which are white washed before, the old white wash should be 1st removed. & repairing to the plastered work is carried out.
- ✓ The colour wash is applied with jute brush. Three coats are generally applied each after the previous coat has completely dried.

.....THE END.....