

# Industrial Engineering:

## Introduction

- The American Institute of Industrial Engineers (AIIE) has defined the Industrial Engineering as “Concerned with design, improvement and installation of integrated systems of people, materials, equipment and energy.”
- Industrial Engineering is going to play a pivotal role in increasing the productivity. It is the engineering approach to the detailed analysis of the use and cost of the resources of an organization. The main resources are men, money, materials, equipment and machinery.
- The Industrial Engineer carries out such analysis in order to achieve the objectives (to increase productivity or profits etc) and policies of the organization.

Main function of an Industrial Engineer

- Design of a system and management of that system
- Productivity Improvement

Productivity Improvement means:

- More efficient use of resources
- Less waste per unit of input supplied
- Higher levels of output for fixed levels of input supplied

The inputs are:

- Human efforts
- Energy
- Materials
- Invested capital

Present state of Industrial Engineering:

- Value engineering
- Operation research
- CPM and PERT
- Human Engineering(Ergonomics)
- System analysis
- Advances in Information Technology and Computer packages
- Mathematical and statistical tools

### Activities of Industrial Engineering:

- Selection of processes and assembling methods
- Selection and design of tools and equipment
- Design of facilities including plant location layout of buildings, machines and equipments material handling system, raw materials and finished goods storage facilities.
- Design and improvement of planning and control system for production, inventory, quality and plant maintenance and distribution systems.
- Developing a cost control system such as budgetary control, cost analysis and standard costing.
- Development of time standard, costing and performance standards
- Development and installation of job evaluation system
- Installation of wage incentives schemes
- Design and installation of value engineering and analysis system
- Operation research including mathematical techniques and statistical analysis
- Performance evaluation
- Organization and methods
- Project feasibility studies
- Supplier selection and evaluation

### Objective of Industrial Engineering:

- To establish methods for improving the operations and controlling the production costs
- To develop programs for reducing those costs

### Technique of Industrial Engineering :

- Method study
- Time study
- Motion study
- Financial and non-financial incentives
- Value analysis
- Production, planning and control
- Inventory control
- Job evaluation
- Material handling analysis

- Ergonomics(Human engineering)
- System analysis
- Operation research techniques
- Other techniques

*Applications of Industrial Engineering :*

- In health services
- In government organizations
- In banking
- Others such as marketing, finance, purchasing, industrial relations etc

## Chapter - 1 Motion and Time study

### Work study:

Work study investigates the work-done in an organization and it aims at finding the best and most efficient way of using available resources. i.e. men, material, money and machinery.

### Method study:

Method study is the systematic recording and critical examination of existing and proposed ways of doing work, as a mean of developing and applying easier and more effective methods and reducing costs.

### Work measurement:

Work measurement is the application of techniques designed to establish the time for a qualified worker to carry out a specified job at a defined level of performance.

### Necessity of work study:

- Work study is a means of enhancing the production efficiency (productivity) of the firm by elimination of waste and unnecessary operations.
- It is a technique to identify non value adding operations by investigation of all the factors affecting the job.
- It is the only accurate and systematic procedure oriented technique to establish time standards.
- It is going to contributes to the profit as the saving will start immediately and continue throughout the life of the product.
- It has got universal application

### Advantages of work study:

- It helps to achieve the smooth production flow with minimum interruptions.
- It helps to reduce cost of the product by eliminating waste and unnecessary operations.
- Better worker-management relations.
- Meets the delivery commitment
- Reduction in rejections and scrap and higher utilization of resources of the organization
- Helps to achieve better working conditions
- Better work place layout
- Improves upon the existing the process or methods and helps in standardization and simplification
- Helps to establish the standard time for and operation of job which has got application in man power planning, production planning.

## Procedure:

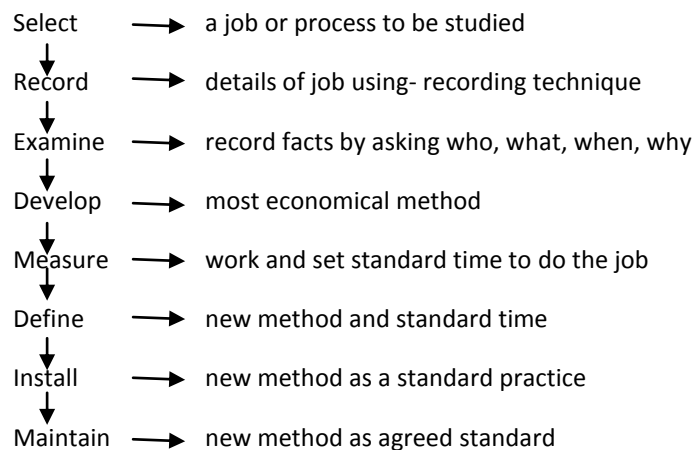

## Work study:

- **Method study:**

Method study is the systematic recording and critical examination of existing and proposed ways of doing work, as means of developing and applying easier and more effective methods and reducing costs.

## Objective:

- To improve work methods and procedures.
- To determine the best sequence of doing work.
- To smoothen material flow with minimum of backtracking and to improve layout.
- To improve the working conditions and hence to improve labour efficiency.
- To improve plant utilization and material utilization.
- Elimination of waste and unproductive operations.
- To reduce the manufacturing costs through reducing cycle time of operations.

## Procedure:

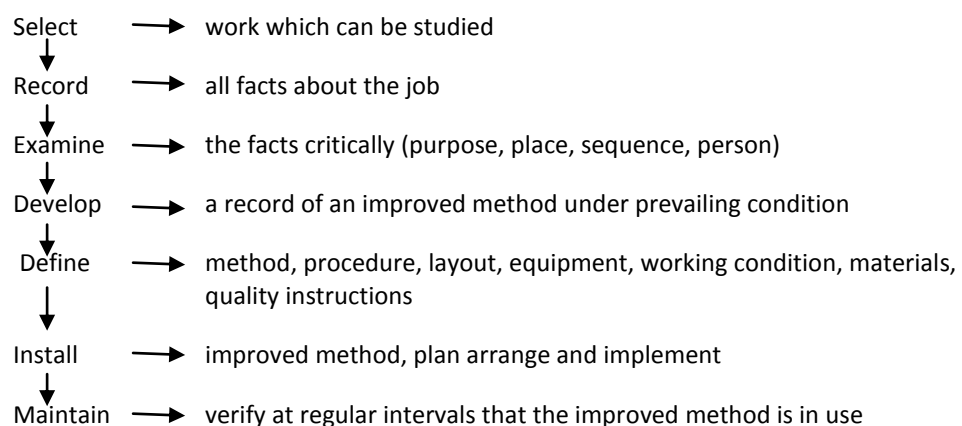

### Method study procedure:

1. Select the work worth studying and define the objectives to be achieved.  
An objective may be to reduce the manufacturing cost or to reduce bottlenecks or to reduce fatigue incurred by the workers in order to increase their efficiency.
2. Record all the relevant informations pertaining to the existing method in details and in the form of a chart to obtain a more clear picture about the same. Recordings can be done with the help of
  - a. Process charts  
Out line process charts  
Flow process charts, (Man, Material& Equipment Type)  
Two handed process chart  
Multiple activity charts
  - b. Diagrams  
Flow diagram  
String diagram  
Cycle graph  
Chronocycle graph
  - c. Motion and Film analysis  
SIMO chart
  - d. Models
3. Examine the recorded events critically and in sequence Critical examination involves answer to a no. of Questions.  
The basic questions are  
Purpose → What is done?  
Person → Who does it?  
Place → Where it is done?  
Means → How it is done?  
Sequence → When is it done? alternative ways of doing, best method of doing.
4. Develop the best method as resulted from critical examination and record it. The developed method should be
  - Practical and feasible
  - Safe and effective
  - Economical
  - Acceptable to design, production control and sales department
5. Install the developed method or the improved method. It involves planning arranging and implementing.
6. Maintain the new method i.e. ensure the proper functioning of the installed method by periodic checks and verification.

### Selection of the job for method study:

Cost is the main criteria for selection of a job, process and department for method analysis. The job is selected such that

- Improvement in quality with lesser scrap
- Increased production through better utilization of resources
- Elimination unnecessary operations and movements
- Improved layout leading to smooth flow of material and a balanced production line.
- Improved working conditions

The job should be selected for the method study based upon the following considerations

1. Economic aspects
  - (i) bottleneck operations
  - (ii) Production lot of scrap or defective
  - (iii) Poor utilization of resources
  - (iv) Excessive movement of materials
2. Technical aspects
  - (i) knowledge of technical
  - (ii) Job having consistent quality
  - (iii) Operations generating lot of scrap
  - (iv) Frequent complaint from work regarding the job
3. Human considerations
  - (i) workers complaining about unnecessary and tiring work
  - (ii) More frequency of accidents

### Recording techniques:

After selecting the job to be studied, then record all facts relating to the existing method.

### Method study symbols:

- Operation
- Inspection
- ⇒ Transportation
- D Delay
- ▽ Storage

#### 1. Operation ○ :

- An operation occurs when an object is intentionally changed in one or more of its characteristics.
- An operation takes the object one stage ahead towards completion.  
Ex – turning, drilling, chemical reaction, lifting and loading.

2. Inspection □ :

An inspection occurs when an object is examined and compared with standard for quality and quantity.

Ex – visual observation for finish, count of quantity of incoming material

3. Transportation ⇨:

Transport indicates the movement of workers materials or equipments from one place to another.

Ex – movement of material from one station to another, workers travelling to bring tools

4. Delay D:

A delay occurs when the immediate performance of the next planned things does not take place.

Ex – Work waiting between consecutive operations

Workers waiting at tool cribs

Operators waiting for instructions from supervisor

5. Storage ▽:

A storage occurs when the object is kept in an authorized custody and is protected against unauthorized removal.

Ex—materials kept in stores to be distributed to various work centers.

Recording technique:

1. Charts
2. Diagrams
3. Templates and models

Charts:

1. Operation process chart (Outline process chart)
2. Flow process charts
  - I. Man type
  - II. Material type
  - III. Equipment type
3. Multiple activity chart
4. Two handed process chart
5. Travel chart
6. SIMO chart

Diagrams:

7. Flow and string diagrams
8. Models and templates
9. Cycle-graph and chrono-cycle graph

Charts: most popular method of recording facts.



1. Operation process chart (outline process chart):

Charts are generally represented by symbols because symbol produces a better picture and quick understanding of the facts.

An outline process chart gives the bird's eye view of the whole process by recording only the activities and inspection involved in the process. It uses only two symbols ○ and □. It helps visualizing various possibilities of alternation and improvement.

Manufacture of pipe assembly:

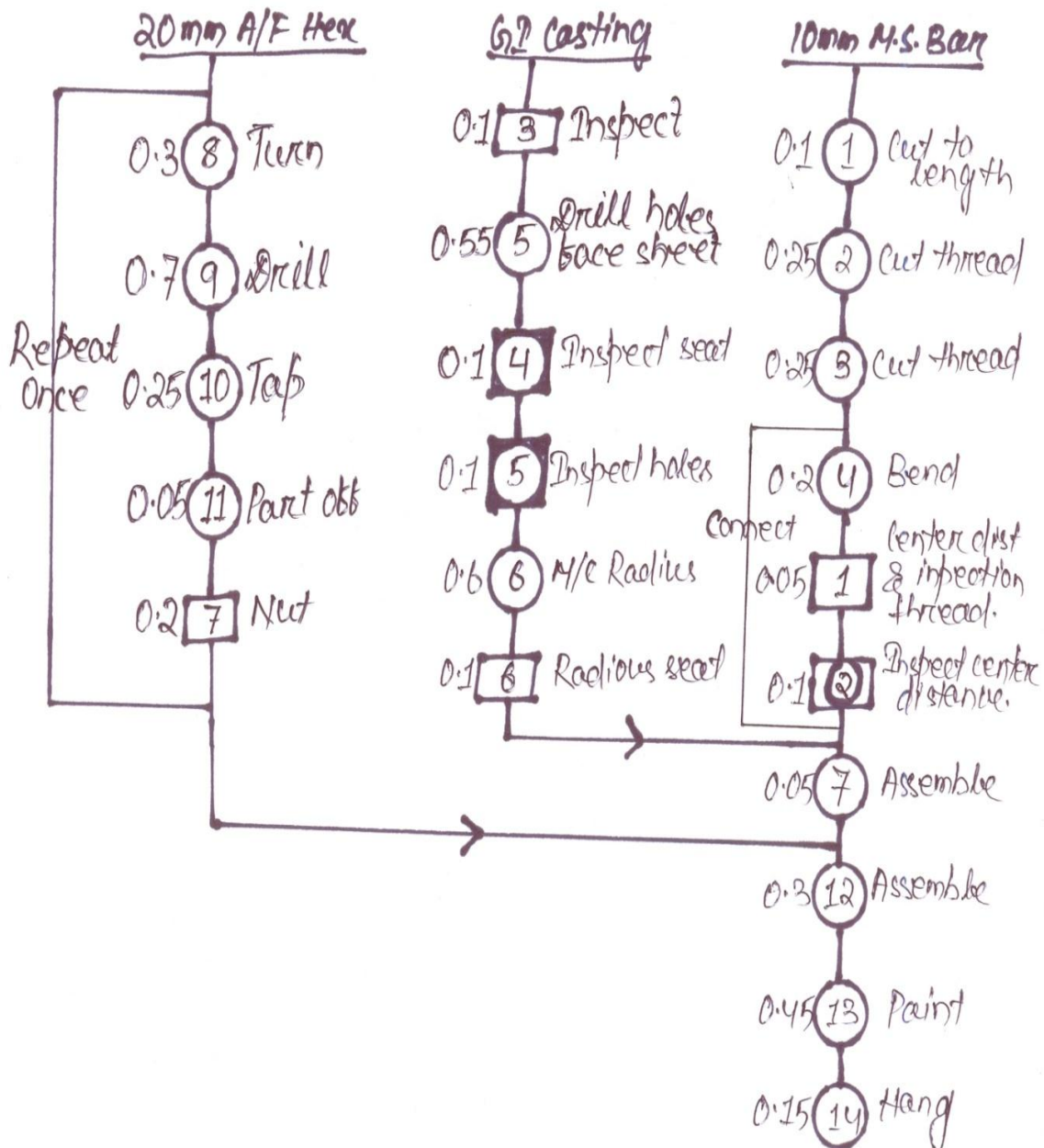

2. Flow process chart (Man type): Writing a letter

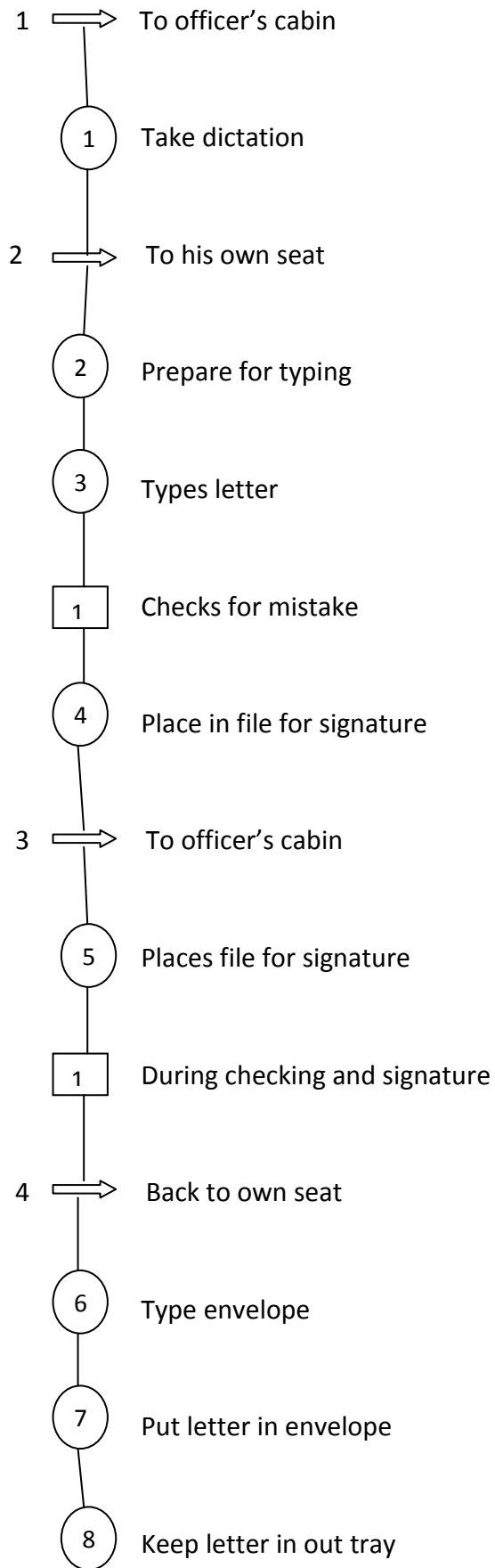

Activity	Operation ○ □ ▽ D ⇨	Distance (m)	time
Casting lying in foundry store	1 ●		
Moved to gas cutting machine	1 ●	10	3
Wait, cutting machine being set	1 ●		5
Risers cut	1 ●		20
Wait for trolley	2 ●		10
Moved to machine shop	2 ●	20	6
Inspected before machining	1 ●	-----	15

Man and material type:

Man in inspection department

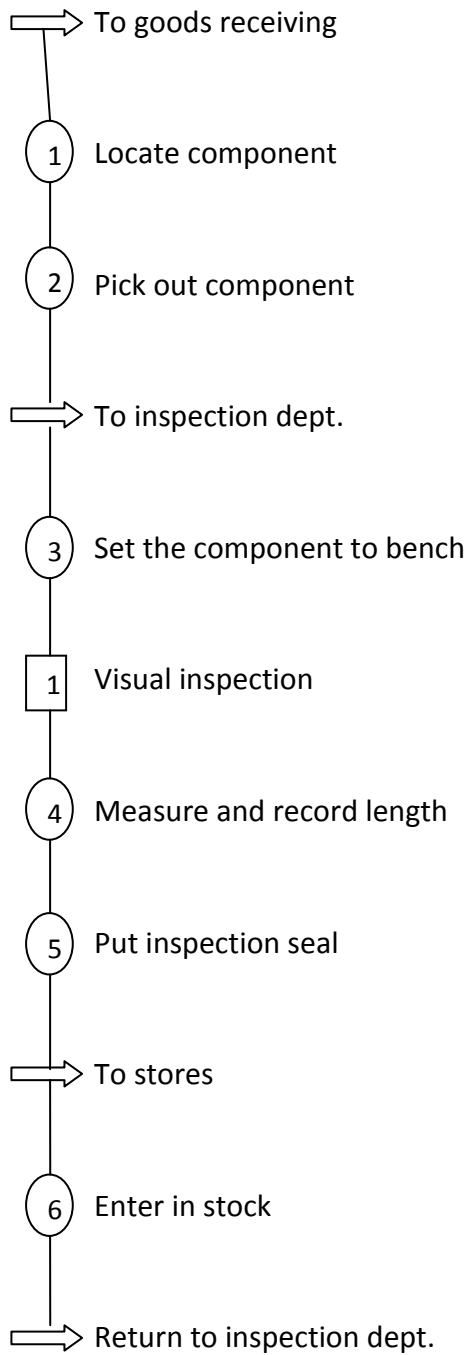

Material in goods receiving

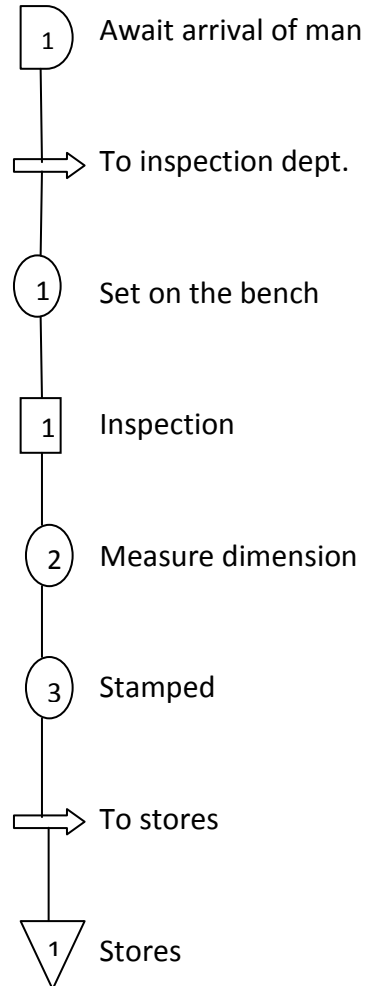

## Advantage

- To reduce the distance travelled by men
  - To avoid waiting time and unnecessary delays
  - To reduce the cycle time by combining or eliminating operations
  - To fix up the sequence of operations
  - To relocate the inspections stages
3. Two handed process chart

It is the most detailed type of flow chart in which activities of the workers hands are recorded in relation to one another.

Assembly of nut and bolt

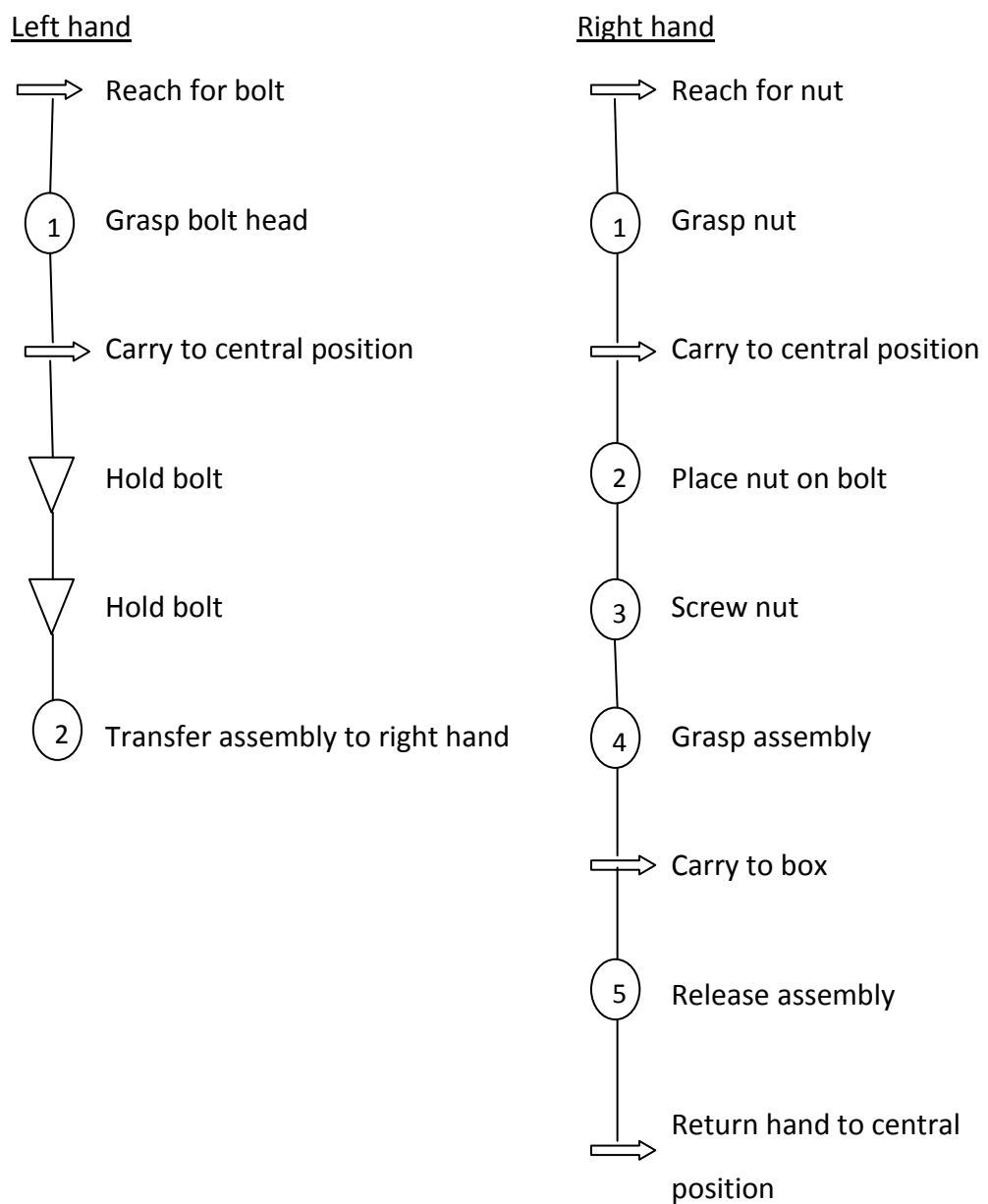

### Flow diagram:

Flow diagram shows the path of movements. In the path of movements, there are often undesirable features such as congestion, back tracking and unnecessary long movements. To record these unnecessary features, representation of the working area in the form of flow diagrams.

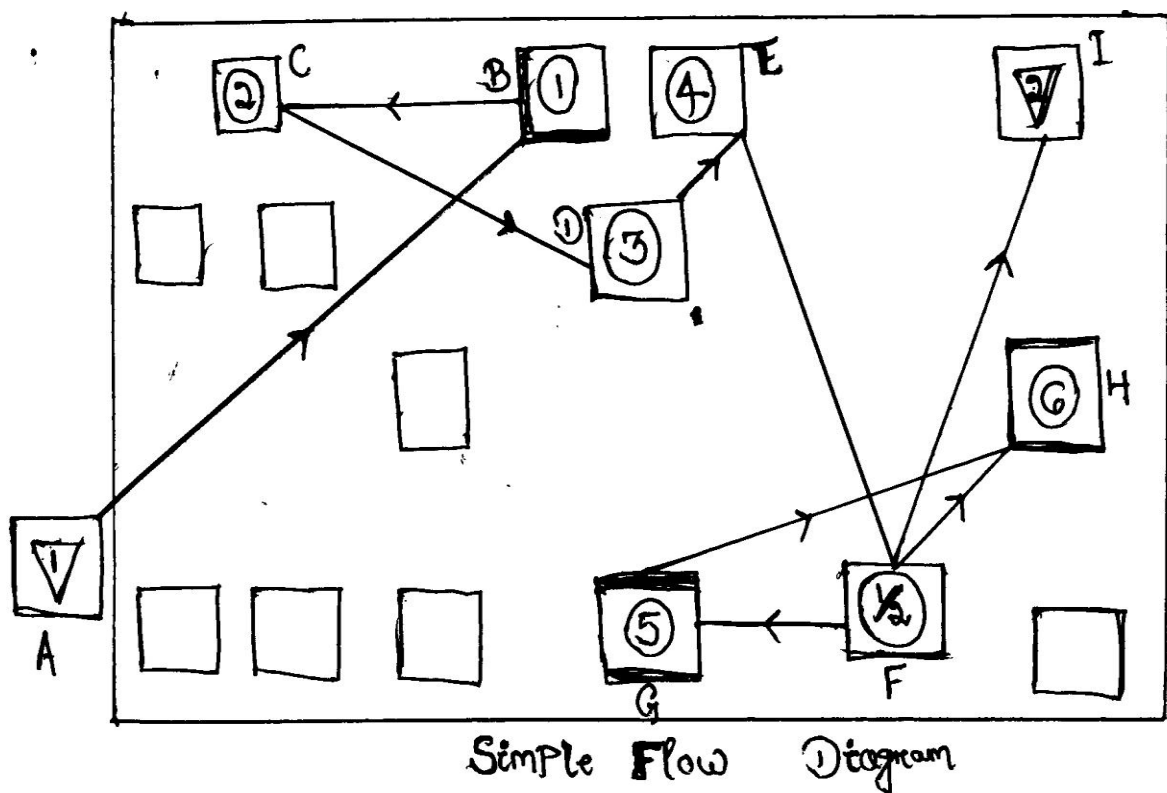

### Critical examination:

The objective of critical examination of recorded facts of an existing or proposed method is to determine the reasons of each event and to make a systematic list of all the possible improvements for later development.

It is conducted through a systematical and methodical questioning process.

### Primary questions

1. Purpose
2. Means
3. Sequence
4. Place
5. Person

### Secondary question

- What else could be done?  
how else could it be?  
where else could it be?  
when else could it be?  
who else could it be?

### Development and selection of new method:

For development of new method

- Eliminate all unnecessary operations
- Combine operations and elements
- Change the sequence of operations
- Simplify the necessary operations

### Steps:

- Evaluation
- Investigation
- Selection

### Installation of the proposed method:

- Preparation of change proposal to management
- Steps to prepare its implementation on acceptance of proposal
- To get formal approval from management
- To implement the accepted proposal

### Maintain the method:

Follow up is required after implementation.

- Monitoring and control
- Audit of the savings
- Review of the approach
- Evaluation of effectiveness of proposed method

## Work measurement

### Time study:

The application of techniques designed to establish the time for a qualified workers to carry out a specific job at a define level of performance.

OR

The study may be the study of the amount of time required to complete a unit of work under existing working conditions, using the specified method and machinery, by an operator, able to do the work in proper manner at standard pace.

### Objectives:

1. Determines the time required doing a job, thus it compares alternative methods and establishes. The fastest method.
2. Decides manpower required for a job, correct initial manning.
3. Decides equipment requirements.
4. Provides information for effective production planning and control.
5. Aids in calculating exact date of delivery.
6. Decides realistic labour budgeting.
7. Cost reduction and cost control.
8. Results in effective labour control.

### Techniques of work measurement:

1. Time study(stopwatch technique)
2. Synthesis
3. Work sampling
4. Analytical estimating
5. Predetermined motion and time study

### Steps in making time study:

1. Select the work to be studied.
2. Obtain and record all the information available about the job, the operator and working conditions likely to affect the time study work.
3. Breakdown the operation into elements.
4. Measure the time by means of a stopwatch, taken by the operator to perform each element of the operation.
5. Assess the operators effective speed of work relative to the observer's concept of normal speed. This is called performance rating.
6. Adjust the observed time by rating factor to obtain normal time for each element.



$$\text{Normal time} = \frac{\text{observed time} \times \text{rating}}{100}$$

7. Add suitable allowances to compensate fatigue, personal needs, contingencies etc to give standard time for each element.
8. Complete allowed time for the entire job by adding elemental standard times considering frequency of occurrence of each element.
9. Make a detailed job description describing the method of which the standard time is established.
10. Test and review standards where necessary.

Procedure for time study :

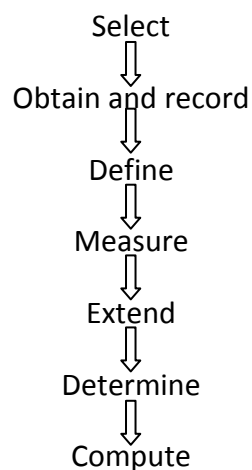

### 1. Selecting job for time study:

Time study may be done for

- The job in question is new one or not previously carried out.
- Change in method of existing time standards
- Complained received from workers.
- Bottle neck operations
- Change in management policy

### General guidelines:

- Bottleneck operations
- Repetitive jobs
- Using greater deal of manual labour
- Jobs with longer cycle time
- Sections frequently working overtime

## 2. Obtaining and recording information:

- Operator working at a normal pace neither too fast nor too slow
- Part no. machine no., speed and feed, materials, operator details
- Working conditions like temp, dust, smoke, vibration, noise etc.
- Working position such as standing, bending etc

## 3. Breaking the job into elements

- To separate productive time from unproductive activities.
- Rate of performance be assessed
- Fatigue associated
- Enable detailed work specification
- Accuracy of ratings

### Observed time(OT) into normal time(NT):

The representative time established from observation data is the time which an operator has taken while working at a certain pace

$$\text{Normal time} = \frac{\text{observed time} \times \text{performance rating}(\%)}{100}$$

Some additional time is added to normal time to arrive at standard time.

Allowances are relaxation, interference and contingency and policy allowance.

### Stopwatch time study:

#### Performance rating:-

It is the process of adjusting the actual pace of working of an operator by comparing it with the mental picture of pace of an operator working at normal speed.

$$\text{Performance rating} = \frac{OT}{NT} \times 100$$

Rating means gauging and comparing the pace rate of the performance of a worker against standard performance level set by time study engineer.

### Factors affecting performance rating:

1. Variations in the quality of material
2. Operating effective of tools and equipments
3. Changes in methods or conditions of operation

4. Change in working condition like heat, light, dust
5. Quality of the product
6. Variations due to operator's ability
7. Variations due to his attitude of mind

### Methods:

1. Speed rating
2. Westing house system of rating
3. Synthetic rating
4. Objective rating

### Speed rating:

- The speed rating is found by the observer by comparing pace of operators working with his own concept of normal pace.
- An average worker is rated 100%.
- Better than average worker is rated higher than 100 %.
- Below average worker will be rated below 100 %. If 125 % is rated, it means the speed is 25 % higher than the observer's concept of normal rating. If 80 % is rated, it means the speed is 20 % lower than the observer's concept of a normal worker.

### Allowances:

It is impossible to work throughout the day. Allowances must be made to enable the worker to attend his personal needs.

1. Relaxation allowance
2. Interference allowance
3. Contingency allowance

#### 1. Relaxation allowance:

Relaxation allowances is a addition to basic time intended to provide the worker with the opportunity to recover from physiological and psychological effects of carrying out specified work under specified conditions and to allow attention to personal needs.

Personal needs allowance are drinking water, smoking, washing hands.

Allowance for basic fatigue is energy expended during working.

## 2. Variable allowance:

Who is working under poor environmental conditions that cannot be improved?

## 3. Interference allowance:

When a no. of machines assigned to the operator.

## 4. Contingency allowance:

- Tool breakage involving removal of tool from the tool holder
- Power failure of small duration
- Obtaining necessary tools and gauges from central tool store.

## Standard rating:

It is the average rate or pace at which a qualified worker will naturally work if he is motivated to apply himself to his work.

## Normal rating:

It is the average rate of pace at which a qualified worker will naturally work even if he has no specific motivation to apply himself to his work.

## Work sampling:

A technique in which a statistically competent no. of instantaneous observations are taken over a period of time, of a group of machines, process or workers. Each observations recorded for a particular activity or delay is a measure of the percentage of time observed by the occurrence.

OR

It relies upon statistical theory of sampling and probability theory. It can tell that what % of the working day, a person spends how, how much time he works, what time he expends for his personal needs and for how long he remains idle.

## Procedure:

1. Define the problem i.e. determine the main objectives and define each activity to be measured.
2. Make sure that all persons connected with the study (workers and supervisors) understand the objective of the study.
3. State the desired accuracy limits for the ultimate results.

4. Conduct a pilot study to

- Estimate the approximate % occurrence of the activity.
- Estimate the required no. of observations of the desired accuracy set.
- Ensures that workers have become habituated to the visits of the work study engineer.
- Design the actual study
- Using the data obtained from pilot study, calculate no. of observations to be made.

Work sampling example:

If a work study engineer takes 25 rounds of the machine shop in a day, observes an operator 'X' and finds that

15 times he was working on the machine.

4 times he was setting up or cleaning the machine.

3 times he was not doing anything.

3 times he had gone for his personal needs.

It shows 60% of his time is actually working over the machine. 12 % of his time he is idle.

## OPERATION RESEARCH

### Optimization techniques:

The word optimization is form optimum which implies a point at which the conditions are best and most favorable.

An optimum point may represent a maximum position or minimum position.

### Method for optimizing:

- a) Search
- b) Differential calculus
- c) Statistical methods
- d) Linear programming
  - i. Graphical method
  - ii. Transportation method
  - iii. Simplex method
- e) Queuing theory
- f) Dynamic programming

### Application:

Load allocation problems, component selection, load sharing.

### Operation research:

Operation research signifies research on operations. It is the organized application of modern science, mathematics and computer techniques to complex military, government, business or industrial problems arising in the direction and management of large systems of men, materials, money and machines

### Methodology

1. Understand the actual real situation, capture the same and define the problem
2. Formulate a mathematical model
3. Develop a mathematical solution
4. Interpret the solution and prepare the information in such a form that it is meaningful, intelligible and quantitative. Translate it in to a decision.
5. Implement the decision to the real situation
6. Verify the results

### Methods of operation research

1. Linear programming
  - a) Graphical linear programming
  - b) Transportation method
  - c) Simplex method
2. Wait line queuing theory
3. Game theory
4. Dynamic programming

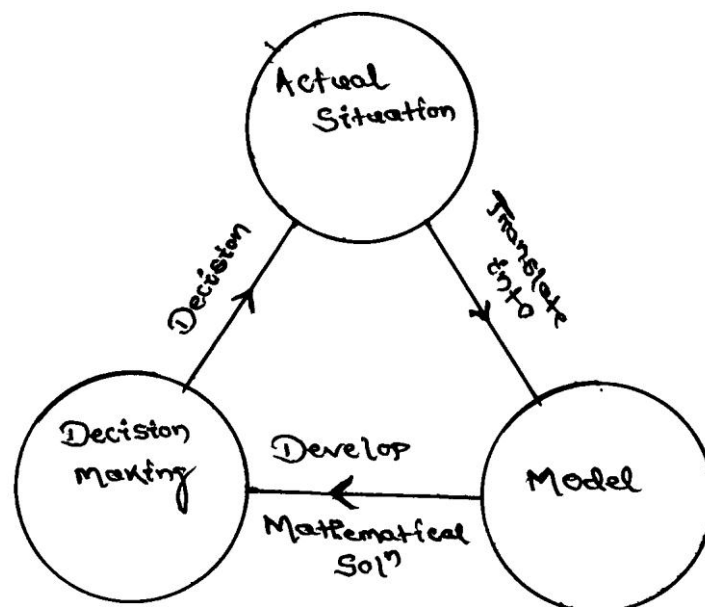

### Linear programming

Linear programming is powerful mathematical technique for finding the best use of limited resources of a concern. It may be defined as a technique which allocates scarce

available resources under conditions of certainty in an optimum manner to achieve the company objectives which may be maximum overall profit or minimum overall cost.

LP can be applied effectively only if

- a) The objectives can be stated mathematically
- b) Resources can be measured as quantities (no. weight etc)
- c) There are too many alternate solutions to be evaluated conveniently
- d) The variables of the problem bear a linear relationship i.e. Doubling the units of resources will double the profit.

Problem solving is based upon the system of linear equation:

Standard form of linear programming problem:

Let  $x_1, x_2, x_3, \dots, x_n$  are the decision variables.

Optimize (maximum or minimize)

$$Z = c_1x_1 + c_2x_2 + \dots + c_nx_n \text{ (objective function)}$$

Subject to constraints

$$a_{11}x_1 + a_{12}x_2 + \dots + a_{1n}x_n \leq b_1$$

$$a_{21}x_1 + a_{22}x_2 + \dots + a_{2n}x_n \leq b_2$$

$$\begin{matrix} \cdot & \cdot & & \cdot & \cdot \\ \cdot & \cdot & & \cdot & \cdot \\ \cdot & \cdot & & \cdot & \cdot \end{matrix}$$

$$a_{m1}x_1 + a_{m2}x_2 + \dots + a_{mn}x_n \leq b_n$$

$$x_1, x_2, x_3, \dots, x_n \geq 0 \text{ (non-negative restriction)}$$

where  $c_1, c_2, c_3, \dots, c_n$  are cost or profit coefficients.

$$a_{ij} \text{ (} i = 1, 2, 3, \dots, n \text{)}$$

$$\text{(} j = 1, 2, 3, \dots, n \text{)}$$

$b_1, b_2, \dots, b_n$  are called requirement or availability.

LPP can solved by two methods.

1. Graphical method: when two decision variables are involved. This is simple.
2. Simplex method: useful for any no. of decision variable in the problem and no. of constraints.

Formulation of LP problem:

1. From the given problem, identify the key decisions to be made.
2. Identify the decision variables, whose values give the solution to the problem.



3. Write the objective in the quantitative terms and express it as a function of linear variables.
4. Study the constraints and express them as a linear equation.

### Graphical method:

Simple two dimensional linear programming problems can be easily and rapidly solved by this technique. This method can be easily be applied upto 3 variables.

Example 1: A furniture manufacturer makes two products  $X_1$  &  $X_2$  namely chair and tables. Each chair contributes a profit of Rs 20 and each table that of Rs 40. Chairs and tables from raw material to finished product, are processed in 3 sections  $S_1, S_2, S_3$ . In section  $S_1$  each chair ( $X_1$ ) requires 1 Hr and each table ( $X_2$ ) requires 4 Hrs of processing. In section  $S_2$ , each chair requires 3 Hrs and each table 1 Hr and in section  $S_3$  the times are 1 and 1 Hr respectively. The manufacturer wants to optimize his profits if sections  $S_1, S_2, S_3$  can be availed for not more than 24, 21 and 8 Hrs respectively.

ANS:

Let Chair =  $X_1$

Table =  $X_2$

Maximum  $Z = 20X_1 + 40X_2$

	<u>Chair</u>	<u>Table</u>	<u>Total</u>
$S_1$	1	4	24
$S_2$	3	1	21
$S_3$	1	1	8

Subject to :

$$X_1 + 4 X_2 \leq 24 \quad (C_1)$$

$$3X_1 + X_2 \leq 21 \quad (C_2)$$

$$X_1 + X_2 \leq 8 \quad (C_3)$$

$$X_1, X_2 \geq 0 \quad (C_4)$$

Where,  $C_1$  is constraint No. 1.

C<sub>2</sub> is constraint No. 2.

C<sub>3</sub> is constraint No. 3.

C<sub>4</sub> is constraint No. 4.

Example 2: A firm can produce 3 types of cloth says A, B and C. Three kinds of wool are required for it say red wool, green wool and blue wool. One unit length of type A cloth needs 2 yards of red wool and 3 yards of blue wool. One unit length of type B cloth needs 3 yards of red wool, 2 yards green wool and 2 yards blue wool and one unit of type C cloth needs 5 yards of green and 4 yards of blue wool. The company has a stock of only 8 yards of red, 10 yards green wool and 15 yards of blue wool. The profit from sale of 1 unit length of type A is Rs 10, type B is Rs 8 and type C is Rs 5. Determine how the firm should use the available material so as to maximize the profit. Formulate this as LP problem.

ANS:

Let  $x_1$ ,  $x_2$  and  $x_3$  be the no. of units of cloth of type A, type B and type C.

Objective is to maximize profit.

$$Z = 10x_1 + 8x_2 + 5x_3$$

<u>Requirement</u> <u>wool</u>	<u>Clothes</u>			<u>Availability of</u>
	<u>A</u>	<u>B</u>	<u>C</u>	
Red	2	3	—	8
Green	—	2	5	10
Blue	3	2	4	15

$$2x_1 + 3x_2 \leq 8$$

$$2x_2 + 5x_3 \leq 10$$

$$3x_1 + 2x_2 + 4x_3 \leq 15$$

Example 3: A company produces two types of dolls A and B. Doll A is of superior quality and B is of lower quality. Profit on doll A and B is Rs 5 and Rs 3 respectively. Raw material required for each doll A is twice that is required for doll B. The supply of raw material is only 1000 per day of doll B. Doll A requires a special crown and only 400 such clips are available per day. For doll B 700 crowns are available per day. Find graphically the product mix so that the company makes maximum profit.

ANS:

$$\text{Max. } Z = 2x_1 + x_2$$

$$2x_1 + x_2 \leq 1000$$

$$x_1 \leq 400$$

$$x_2 \leq 700$$

$$x_1, x_2 \geq 0$$

Graphical method:

1<sup>st</sup> step:

Formulate the LPM.

$$\text{Max } Z = 20x_1 + 40x_2$$

Subjected to  $x_1 + 4x_2 \leq 24$  ( $c_1$ )

$$3x_1 + x_2 \leq 21$$
 ( $c_2$ )

$$x_1 + x_2 \leq 8$$
 ( $c_3$ )

$$x_1, x_2 \geq 0$$
 ( $c_4$ )

$c_1$  is constrain no. 1 and so on.

2<sup>nd</sup> step:

2<sup>nd</sup> steps convert the constraint inequalities temporarily into equations.

$$x_1 + 4x_2 = 24 \text{ (} c_1 \text{)}$$

$$3x_1 + x_2 = 21 \text{ (} c_2 \text{)}$$

$$x_1 + x_2 = 8 \text{ (} c_3 \text{)}$$

3<sup>rd</sup> steps: Axis are marked on the graph paper and labeled with variables  $x_1$  &  $x_2$ .

4<sup>th</sup> steps:

4<sup>th</sup> step is draw straight lines on the graph paper using constraint equations and to mark feasible solution on the graph paper.

Taking 1<sup>st</sup> constraint equation,

$$x_1 + 4x_2 = 24$$

$$x_1 = 0, x_2 = 6$$

$$x_2 = 0, x_1 = 24$$

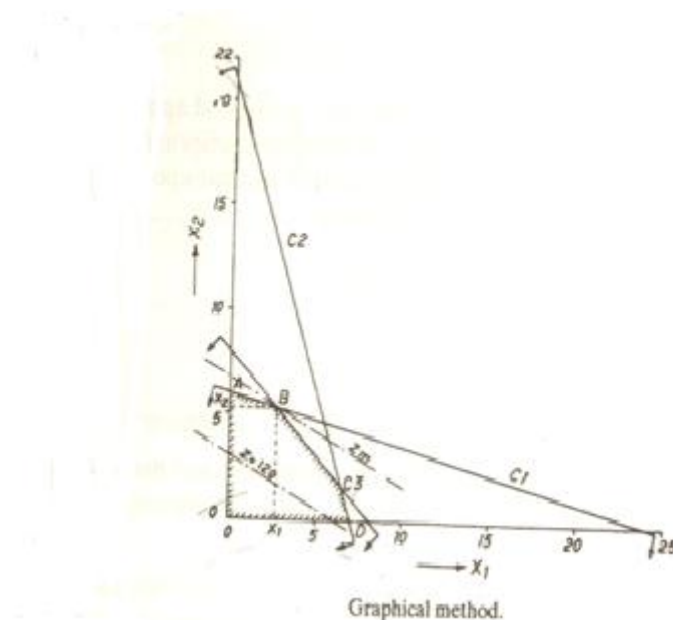

Mark the point of 24 at  $x_1$  axis and point 6 on  $x_2$  axis. The straight line represents  $c_1$  equation.

Similarly,  $c_2$  and  $c_3$  can be plotted.

$$3x_1 + x_2 = 21$$

$$x_1 + x_2 = 8$$

$$x_1 = 0, x_2 = 21$$

$$x_1 = 0, x_2 = 8$$

$$x_2 = 0, x_1 = 7$$

$$x_2 = 0, x_1 = 8$$

According to constrain  $c_4$ ,  $x_1$  &  $x_2$  are greater than or equal to zero, hence the marked area between  $x_1 = x_2 = 0$  and  $c_1, c_2, c_3$  represents the feasible solution.

#### 5<sup>th</sup> step:

A dotted straight line representing the equation Z is drawn, assuming any suitable value of Z say 120.

$$x_1 = 0, x_2 = 3$$

$$x_2 = 0, x_1 = 6$$

#### 6<sup>th</sup> steps:

A straight line  $Z_m$  is drawn parallel to the line Z, at the furthest point of the region of feasible solution i.e. point B, at the intersection of  $c_1$  &  $c_3$ .

The co-ordinates at point B can be found by solving equation  $c_1$  &  $c_3$ .

$$x_1 + x_2 = 8 \text{ (} c_3 \text{)}$$

$$x_1 + 4x_2 = 24 \text{ (} c_1 \text{)}$$

$$3x_2 = 16 \Rightarrow x_2 = 5.3$$

$$3x_1 = 8 \Rightarrow x_1 = 2.7$$

These values of  $x_1$  and  $x_2$  can also be read from the graph itself.

∴ The maximum value of Z is

$$Z_m = 20x_1 + 40x_2 = 20 \times \frac{8}{3} + 40 \times \frac{16}{3} = 266.6$$

# NETWORK ANALYSIS

It is a system which plans projects both large and small by analyzing the project activities. Projects are broken down to individual tasks or activities, which are arranged in logical sequence.

## Projects:

Project is any task which has definable beginning and definable end expenditure of one or more resources.

It is essential to manage effectively the projects through proper planning, scheduling and control as project requires a heavy investment, and is associated with risk and uncertainties.

## Network scheduling:

It is a technique used for planning and scheduling large projects in the field of constructions, maintenance, fabrication and any other areas.

This technique is the method of minimizing the bottlenecks, delays and interruptions by determining the critical factors and coordinating various activities.

## A network diagram:

A network diagram is constructed which presents visually the relationship between all the activities involved. Time, costs and other resources are allocated to different activities.

It helps designing, planning, coordinating, controlling and decision making in order to accomplish the project economically in the minimum available time with the limited available resources.

There are two basic planning and control techniques. They are Critical Path Method (CPM) and Program Evaluation and Review Techniques (PERT).

## Objective of Network Analysis:

1. A powerful coordinating tool for planning, scheduling and controlling of projects.
2. Minimization of total project cost and time.
3. Effective utilization of resources and minimization of effective resources.

4. Minimization of delays and interruption during implementation of the project.

### Application of Network Analysis (PERT and CPM):

1. Research and development projects.
2. Equipment maintenance and overhauling.
3. Construction projects (building, bridges, dams)
4. Setting up new industries
5. Planning and launching of new products.
6. Design of plants, machines and systems
7. Organization of big programs

### Basic concepts in network:

#### Network:

It is a graphical representation of the project and it consists of series of activities arranged in a logical sequence and show the interrelationship between the activities.

#### Activities:

An activity is a physically identifiable part of the project, which consumes time and resources. Each activity has a definite start and end. It is represented by an arrow (→).

#### Event:

An event represents the start or completion of an activity. The beginning and end points of an activity are events.

Ex – Machining a component is an activity.

Start machining is an event.

Machining completed is an event.

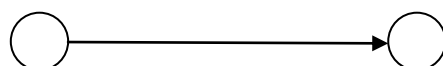

Tail event

Head event

In a network a no. of activities may terminate into single node called merge node and a no. of activities may emanate from a single node called burst node.

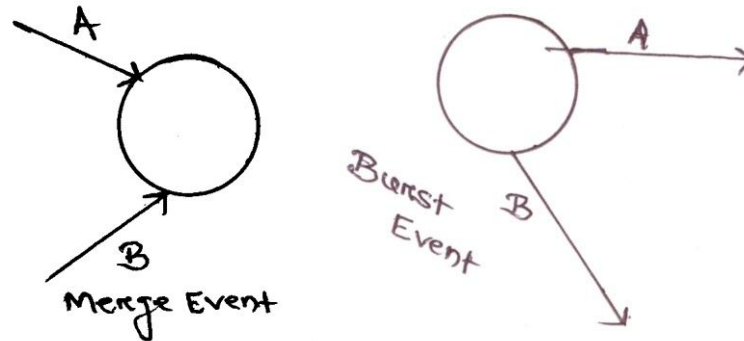

Predecessor and successor activities:

All those activities, which must be completed before starting the activity under consideration are called its predecessor activities.

All the activities which have to follow the activity under consideration are called its successor activities.

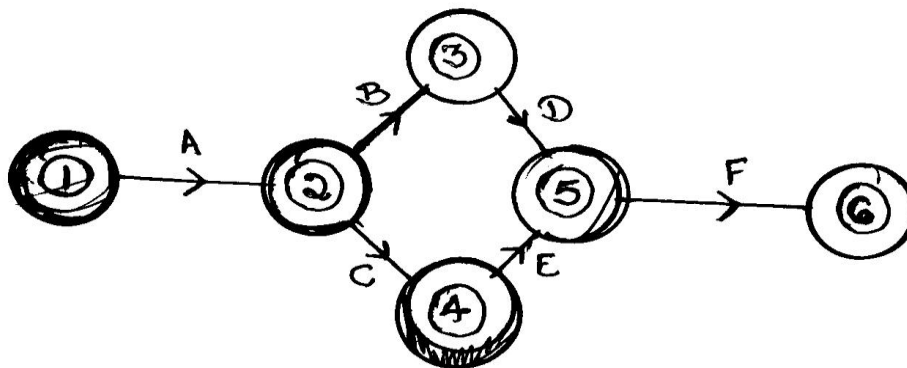

2-3, 2-4 are immediate successors

2-3 & 2-4, 3-5, 4-5 & 5-1 are its successor's activities.

1-2, 2-3 are predecessors to 3-5.

2-3 is the immediate predecessors.

Path:



An unbroken chain of activities between two events is called a path.

Ex – A-B-D-F is a path connecting 1 & 6.

### Dummy activity:

An activity which depicts the dependency or relationship over the other but does not consume time or resources. It is used to maintain the logical sequence. It is used to maintain the logical sequence. It is indicated by a dotted line.

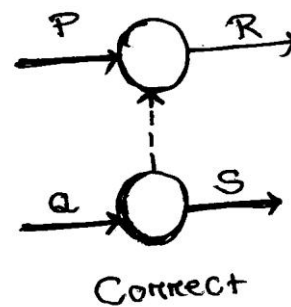
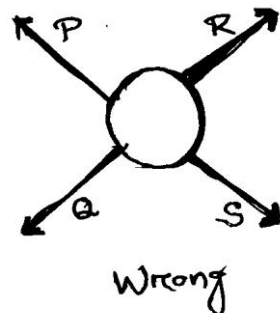

### Terms related to network planning methods:

#### Event (node):

An event is a specific instant of time which marks the start and the end of an activity. Event consumes neither time nor resources. It is represented by a circle and the event no. is written within the circle.

Ex – start the motor, loan approved.

#### Activity:

Every project consists of a no. of job operations or tasks which are called activities. An activity is an element of project and it may be a process, a material handling or material procurement cycle.

Ex – install machinery, arrange foreign exchange.

It is shown by an arrow and it begins and ends with an event. An activity is normally given a name like A, B, C etc i.e. marked below the arrow and the estimated time to accomplish the activity is marked above the arrow.

### Activities are classified as:

#### 1. Critical activities:

In a network diagram, critical activities are those which if consume more than their estimated time the project will be delayed. An activity is called critical if its earliest start time plus the time taken by it is equal to the latest finishing time. A critical activity is marked either by a thick arrow or (//).

#### 2. Non critical activities:

Such activities have provision (slack or float) so that even if they consume a specified time over and above the estimated time, the project will not be delayed.

#### 3. Dummy activities:

When two activities start at the same instant of time, the head events are joined by a dotted arrow and this is known as dummy activity. It does not consume time. It may be non-critical or critical. It becomes a critical activity when its EST = LFT.

### Critical path:

It is that sequence of activities which decide the total project duration. It is formed by critical activities. A critical path consumes maximum resources. It is the longest path and consumes maximum time. It has zero float. The expected completion data cannot be met, if even one critical activity is delayed. A dummy activity joining two critical activities is also a critical activity.

### Duration:

Duration is the estimated or actual time required to complete a task or an activity.

### Total project time:

It is the time which will be taken to complete the project and is found from the sequence of critical activities. It is the duration or critical path.

### Earliest start time (EST):

It is the earliest possible time at which activity can start and is calculated by moving from first to last event in a network diagram.

### Earliest finish time (EFT):

It is the earliest possible time at which activity can finish. i.e. (EST + D)

### Latest finish time (LFT):

It is calculated by moving backward i.e. from last event to first event of the network diagram. It is the last event time of the head event

### Latest start time (LST):

It is the least possible time by which an activity can start.

$$LST = LFT - \text{duration of that activity}$$

### Float or slack:

Slack is with reference to an event and float is with respect to an activity. It means spare time, a margin of extra time over and above its duration which a noncritical activity can consume without delaying the project.

Float is the difference between the time available for completing an activity and the time necessary to complete the same.

There are three type of float.

#### 1. Total float:

It is the additional time which a non-critical activity can consume without increasing the project duration.

$TF = LST - EST$  or  $LFT - EFT$  and it can be - ve.

2. Free float:

If all the non critical activities start as early as possible, the time is the free float.

$$FF = EST \text{ of tail event} - EST \text{ of head event} - \text{activity duration}$$

3. Independent float:

It can be used to advantage. If one is interested to reduce the effort on a non-critical activity in order to apply the effort on a critical activity by reducing the project duration.

$$IF = EST \text{ of tail event} - LFT \text{ of head event} - \text{activity duration.}$$

If IF is negative, then taken as 0.

Numbering of events (Fulkerson's rule):

1. The initial event which has all outgoing arrows with no incoming arrow is numbered '1'.
2. Delete all arrows coming out from node 1. This will convert some more nodes into initial events number these events 2, 3 etc.
3. Delete all the arrows going out from these numbered events to create more initial events. Assign next number to these events.
4. Continue until the final or terminal node which has all arrows coming in, with no arrow going out is numbered.

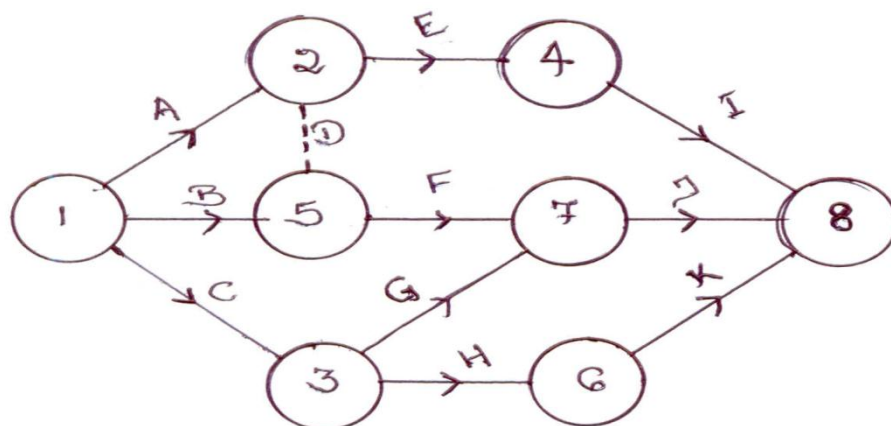

1. Construct the network from the information.

Activity	Immediate predecessor	Time
A	-----	6
B	-----	10
C	-----	14
D	C	6
E	A, B	14
F	E, D	6
G	D	4
H	F, G	4

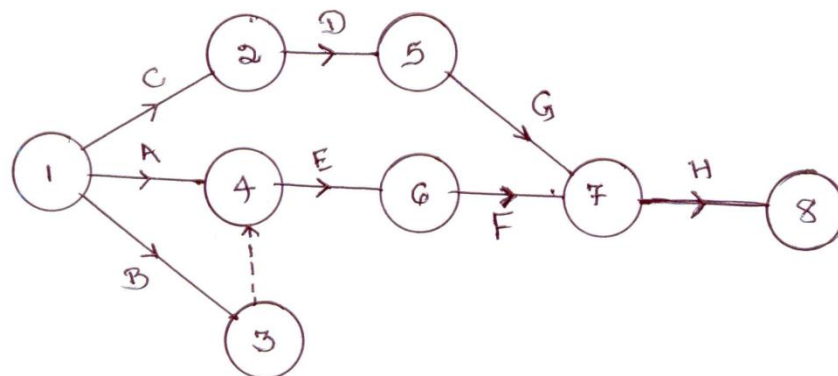

2. Construct the network from the information.

Activity No.	Duration	Activity No.	Duration
0-1	2	0-6	1
1-2	4	3-7	8
2-3	2	6-7	3
3-4	5	5-8	3
2-5	1	7-8	5
4-5	1		

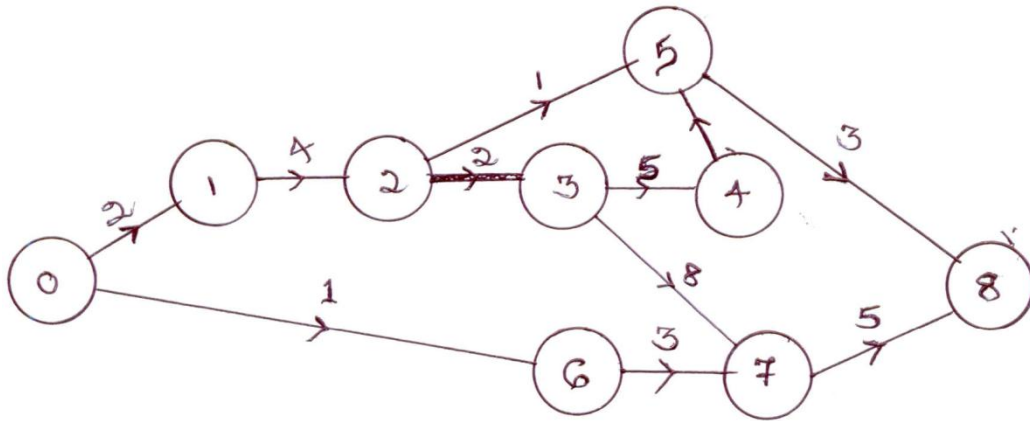

3. Construct the network from the information.

Activity	Time	Activity	Time
1-2	6	3-5	11
1-6	5	4-5	6
2-3	13	6-7	11
2-4	4	5-8	3
-----	-----	7-8	15

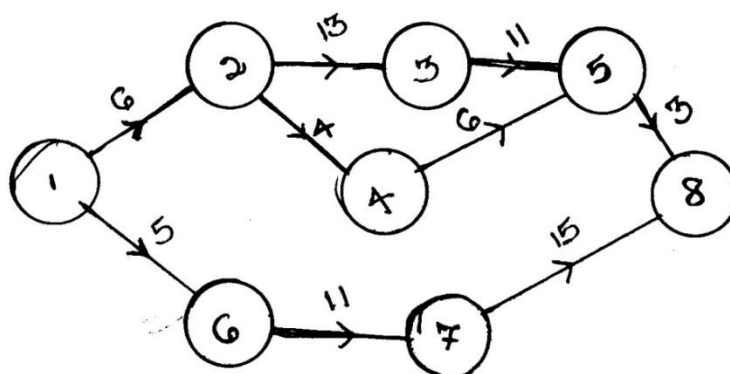

Critical Path Method:

In the critical path method the activity times are known with certainty. For each activity EST and LST are computed. The path with the longest time sequence is called critical path. The length of the critical path determines the minimum time in which the entire project can be completed. The activities on the critical path are called critical activities.

### Objective:

1. Determining the completion time for the project.
2. Earliest time when each activity can start.
3. Latest time when each activity can start without delaying the total project.
4. Determining the float for each activity.
5. Identification of the critical activities and critical path.

### Example:

A small engineering project consists of 6 activities namely A, B, C, D, E & F with duration 4, 6, 5, 4, 3 & 3 days respectively. Draw the network diagram and calculate EST, LST, EFT, LFT and floats. Mark the critical path and find total project duration

Activity	Duration (days)	EST	LST (LFT - D)	EFT (EST + D)	LFT	TF
A	4	0	0	4	4	0
B	6	4	4	10	10	0
C	5	10	10	15	15	0
D	4	4	8	8	12	4
E	3	8	12	11	15	4
F	3	15	15	18	18	0

Critical path = 1-2-3-5-6

Total project duration = 4+6+5+3 = 18 days

### Programme Evaluation Review Technique (PERT):

PERT takes into account the uncertainty of activity times. It is a probabilistic model with uncertainty in activity duration.

It makes use of three time estimates.

- I. Optimistic time ( $t_0$ )
- II. Most likely time ( $t_m$ )

III. Pessimistic time ( $t_p$ )

I. Optimistic time ( $t_0$ ):

It is the shortest possible time in which an activity can be completed if everything goes perfectly without any complications.

It is an estimate of minimum possible time to complete the activity under ideal condition.

II. Pessimistic time ( $t_p$ ):

It is the longest time in which an activity can be completed if everything goes wrong.

III. Most likely time ( $t_m$ ):

It is the time in which the activity is normally expected to complete under normal contingencies.

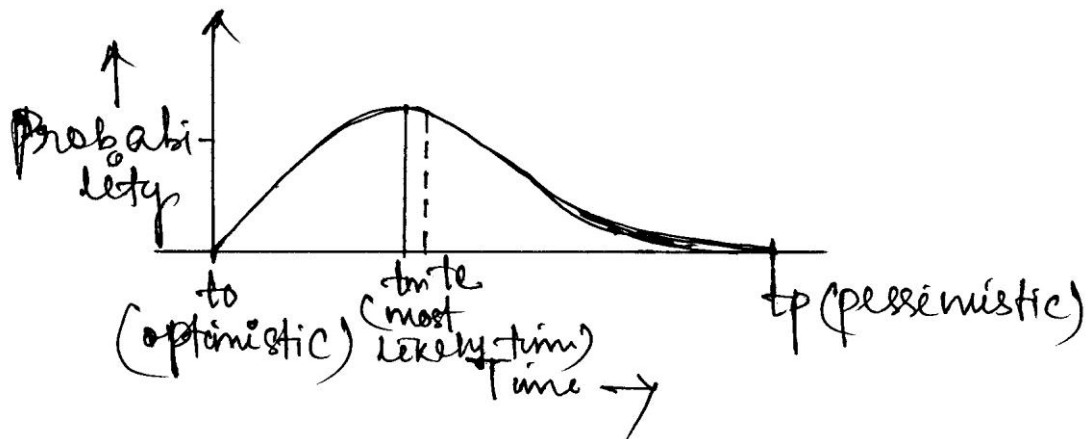

According to the  $\beta$  distribution curve

$$T_e = \frac{1}{6}t_0 + \frac{2}{3}t_m + \frac{1}{6}t_p$$
$$= \frac{t_0 + 4t_m + t_p}{6}$$

The standard deviation of time required to complete each activity.

$$\text{Standard deviation}(\sigma) = \frac{t_p - t_0}{6}$$

$$\text{Variance } \sigma^2 = \left(\frac{t_p - t_0}{6}\right)^2$$

Standard deviation of the time  $t_p$  to complete the project



$$= \frac{tp1-to1}{6} + \frac{tp2-to2}{6} + \dots + \frac{tpn-to1}{6}$$

Mean, variance, standard deviation:

No. of days taken to dig a certain length of trench under varying condition.

48	76	52	40	50
49	60	62	53	50
53	56	67	62	60
61	46	72	70	58

Mean time or average time = 52.5 days

Standard deviation for each entry:

$$48 - 52.5 = -4.5$$

$$49 - 52.5 = -3.5$$

.

.

.

Square the variation

$$(-4.5)^2 = 20.25$$

$$(-3.5)^2 = 12.25 \dots \dots \text{so on}$$

$$\frac{20.25+12.25+\dots}{\text{Total no. of jobs (20)}} = 6.52$$

Square the deviations, add them and divide by no. of jobs to get variance.

Square rating the variance standard deviation can be found.

Example-1 : Stopping distance of a car is given

76	53	64	40	56	60	61
62	30	34	44	38	58	42
39	43	44	54	76	38	42
36	46	63	57	27	48	59
45	53	35	32	47	58	36
63	55	53	44	52	46	51
47	64	54	65	56	65	68
56	66	69	59	67	52	58
44	55	21	64	22	72	37
81	74	84	42	41	75	55

<u>Car interval (in meters)</u>	<u>Tally</u>	<u>Frequency</u>
20 to 29	III	3
30 to 39	IIII IIII	10
40 to 49	IIII IIII IIII I	16
50 to 59	IIII IIII IIII IIII	20
60 to 69	IIII IIII IIII	14
70 to 79	IIII	5
80 to 89	II	2

---

70

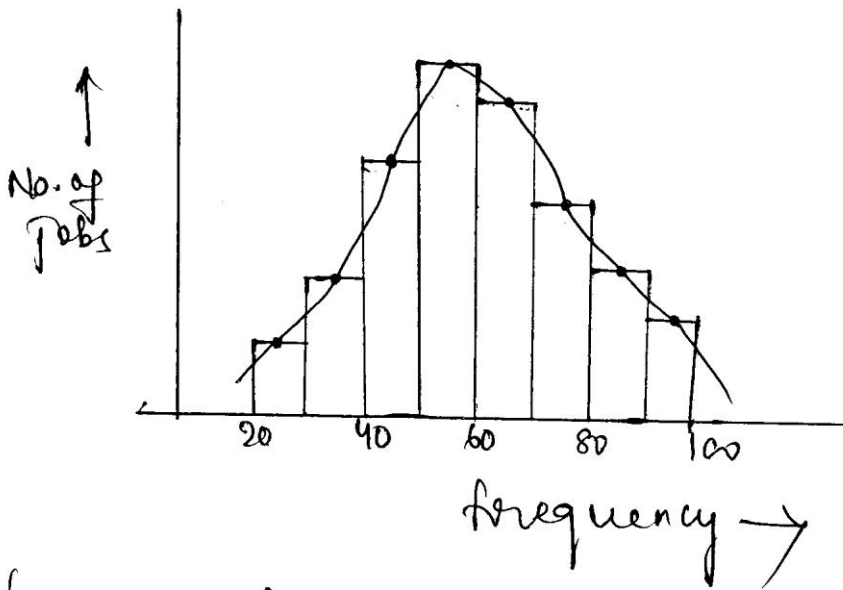

frequency distribution curve

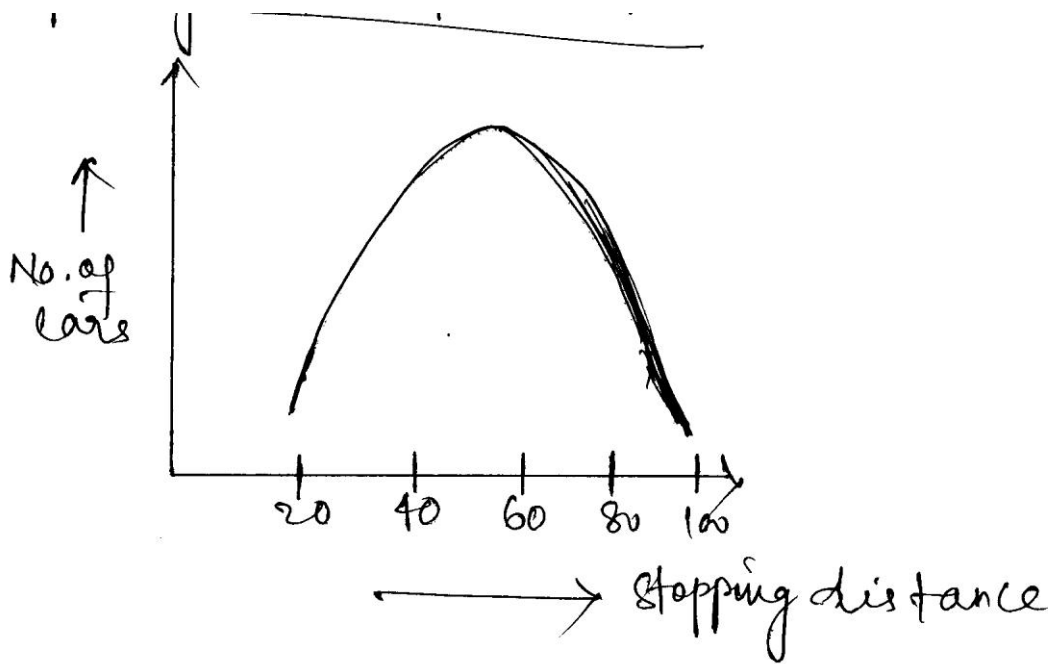

Probability of completion of the project within a scheduled time:

Time:

The probability of completion of the project within scheduled is computed as

1. Calculate the mean of the event time ( $t_e$ ) by adding the times of the activities along the critical path leading to the event.
2. Calculate the variance of the event time by adding up the variances of the activities on the critical path. Take the square root of this variances to get T (standard deviation)
3. Compute standard normal variate

$$Z = \frac{T_s - T_e}{\sigma T} \qquad Z = \frac{D - T_e}{s_t}$$

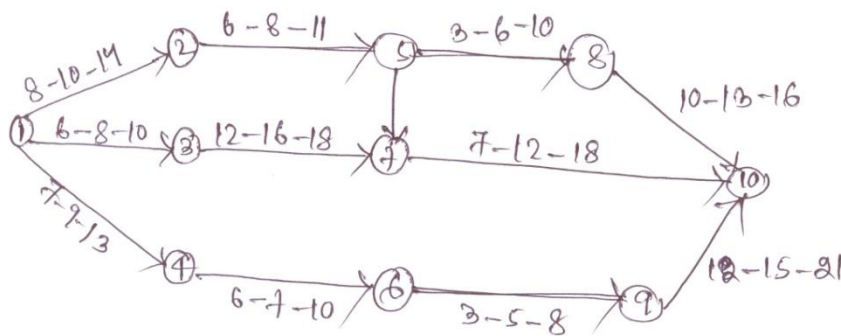

There are 4 paths to reach 1 to 10.

A → 1-2-5-8-10

B → 1-2-5-7-10

C → 1-3-7-10

D → 1-4-6-9-10

	Activity	$t_0$	$t_m$	$T_p$	$T_e$	Sum of $t_e$
Path A	1-2	8	10	14	10.33	37.67
	2-5	6	8	11	8.17	
	5-8	3	6	10	6.17	
	8-10	10	13	16	13	
Path D	1-4	7	9	13	9.33	37.34
	4-6	6	7	10	7.33	

	6-9	3	5	8	
	9-10	12	15	21	
Path C	1-3	6	8	10	35.84
	3-7	12	16	18	
	7-10	7	12	18	
Path B	1-2	8	10	14	37.84
	2-5	6	8	11	
	5-7	5	7	10	
	7-10	7	12	18	

Maximum time consumed is 37.84 is the critical path. So path B is the critical path.

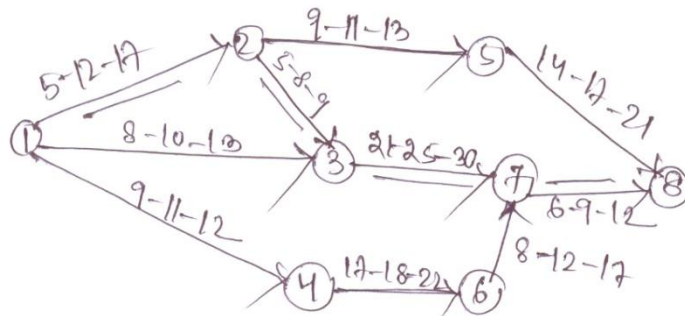

Example – 2:

Construct the PERT network. Find the critical path and variance of each event. Find the project duration at 95 % probability.

Activity	Optimistic time	Pessimistic time	Most likely time
1-2	1	5	1.5
2-3	1	3	2
2-4	1	5	3

3-5	3	5	4
4-5	2	4	3
4-6	3	7	5
5-7	4	6	5
6-7	6	8	7
7-8	2	6	4
7-9	5	8	6
8-10	1	3	2
9-10	3	7	3

Solution:

Activity	$t_o$	$t_p$	$t_m$	$t_e$	Variance
1-2	1	5	1.5	2	4/9
2-3	1	3	2	2	1/9
2-4	1	5	3	3	4/9
3-5	3	5	4	4	4/9
4-5	2	4	3	3	1/9
4-6	3	7	5	5	4/9
5-7	4	6	5	5	1/9
6-7	6	8	7	7	4/9
7-8	2	6	4	4	4/9
7-9	5	8	6	6.16	1/4
8-10	1	3	2	2	1/9
9-10	3	7	3	5	4/9

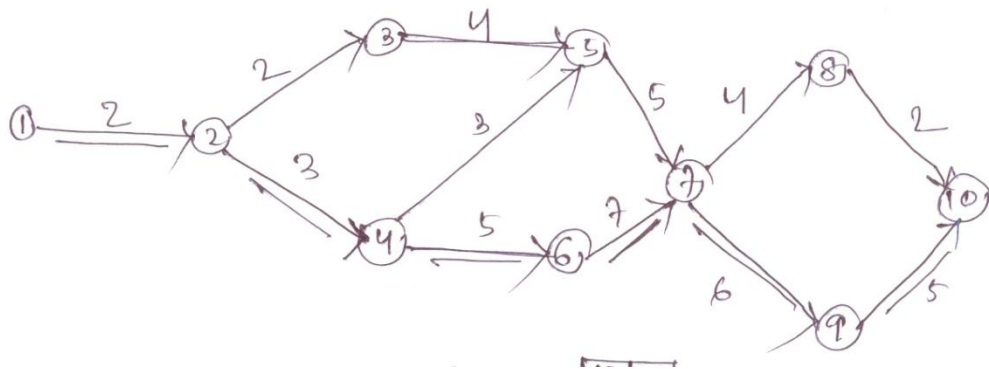

The critical path is 1-2-4-6-7-9-10.

Expected duration of the project = 2+3+5+7+6.16+5 = 28.16 days

Project variance = 4/9+4/9+4/9+4/9+1/4+4/9 = 89/36

$$Z = \frac{\text{due date} - \text{expected date of completion}}{\sigma T}$$

$$= \frac{X-28.16}{89/36} = 0.8289$$

⇒ X = 30.12 days

**Example- 3:**

A small engineering project consists of an activity. Three time estimates for each activity are given

- a) Calculate values of expected time ( $t_e$ ), standard deviation ( $s_t$ ) and variance ( $v_t$ ) for each activity.
- b) Draw the network diagram and mark  $t_e$  on each activity.
- c) Calculate EST and LFT and mark  $t_e$  on each activity.
- d) Calculate total slack for each activity.
- e) Identify the critical paths and mark on the network diagram.
- f) Find the length of critical paths or total project duration.
- g) Calculate variance of critical path.
- h) Calculate the probability that the jobs on the critical path will be finished by the due date of 38 days.
- i) Calculate the approx probability that the jobs on the next most critical path will be completed by the due date of 38 days.
- j) Estimate the probability that the entire project will be completed by the due date of 38 days.
- k) If the project due date changes to 35 days what is the probability of not meeting the due date.
- l) Find the due date which has a probability of 94.5 % of being met.

**Solution:**

Activity	$T_o$	$T_m$	$T_p$	$T_e$	$V_t$
1-2	2	5	14	6	4
1-6	2	5	8	5	1
2-3	5	11	29	13	16
2-4	1	4	7	4	1
3-5	5	11	17	11	4
4-5	2	5	14	6	4
6-7	3	9	27	11	16
5-8	2	2	8	3	1
7-8	7	13	31	15	16

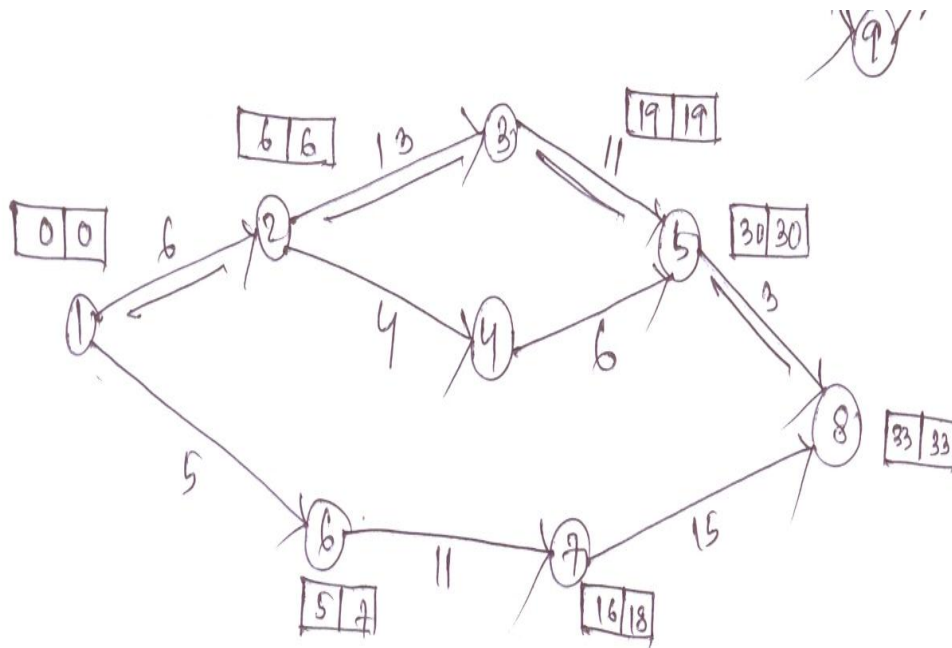

Activity	EST	LST	LST - EST
1-2	0	0	0
1-6	0	2	2
2-3	6	6	0
2-4	6	20	14
3-5	19	19	0
4-5	10	24	14
6-7	5	7	2
5-8	30	30	0
7-8	16	18	2

e) Critical path is 1-2-3-5-8 and it is marked on the network diagram.

f) The length of the critical path or total project duration ( $T_e$ ) is the sum of the duration of each critical activity = 6 + 13 + 11 + 3 = 33 days

g) Variance of the critical path is two of the each critical activity = 4 + 16 + 4 + 1 = 25

h) The probability that the project will meet the scheduled or due date is calculated from the  $Z = \frac{D - T_e}{St}$



Where  $T_e$  = total project duration

$$S_t = \text{standard deviation} = \sqrt{\text{variance}}$$

D = Due or scheduled deviations

$$\therefore Z = \frac{38-33}{\sqrt{25}} = \frac{5}{5} = 1 \quad \text{For } Z = 1, \text{ probability} = 0.841.$$

i) The next most critical path is 1-6-7-8 of 31 days.

$$\text{Variance} = 1+16+16 = 33 \quad s_t = \sqrt{33}$$

$$Z = \frac{38-31}{5.74} = 1.22$$

For  $Z = 1.22$ , probability = 0.888

## PLANT LOCATION & LAYOUT

A plant is a place, where men, materials, money, equipment, machinery etc are brought together for manufacturing products.

The problem of plant location arises when starting a new concern or during the expansion of the existing plant.

Plant location means deciding a suitable location, area, place etc. where the plant or factory will start functioning.

Plant location involves two major activities

- I. To select a proper geographic region
- II. Selecting a specific site within the region

### Plant location problem

1. Selection of region
  2. selection as a community
  3. selection of a particular site
- Conditions that demand city location  
Conditions that demand sub-urban location  
Conditions demanding rural location

### Factors affecting plant location

1. Nearness to raw material – It will reduce the cost of transporting raw material from the vendor's end to the plant sugar, cement, jute and cotton textiles.
2. Transport facilities – A lot of money is spent both in transporting the raw material and the finished goods speedy transport facilities ensure timely supply of raw materials to the company and finished goods to the customers, There are time basic modes of physical transportation, air, road, rail, water and pipe line.
3. Nearness to market – It reduces the cost of transportation as well as the chances of the finished products getting damaged and spoiled in the way.
4. Availability of labour – Suitable labour force, of right kind, of adequate size (number), and at reasonable rates with its proper attitude towards work are a few factors which govern plant location to major extent. The purpose of the management is to face less boycotts, strikes or lockout and achieve lower labour cost per unit of production.
5. Availability of fuel and power – Steel industries are located near source of fuel (coal) to cut down fuel transportation costs. Electric power should remain available continuously in proper quantity and at reasonable rates.

6. Availability of water - Depending on the nature of the plant, water should be available in adequate quantity and should be of proper quality water is essential for paper and chemical industries.
7. Climatic condition – Climate greatly influence human efficiency and behavior. Textile mills require humidity with the developments in the field of heating, ventilating and air conditioning, climate of the region doesn't present much problem of course control of climate needs money.
8. Financial and other aids – Certain states give aids as loans, feed money, machinery, built up sheds etc. to attract industrialist.
9. Land – Topography, area, the shape of the site, cost, drainage and other facilities, the probability of floods, earthquakes etc. influence the selection of plant location.
10. Community attitude – Community attitude towards their work and towards the prospective industries can make or mar the industry. Success of an industry depends on the attitude of the local people whether they want work or not.
11. Supporting industries – All industries will not make all the components and parts by itself and it subcontracts the work to vendors
12. Social Infrastructures – Availability of community facilities like
  - A. Housing facilities
  - B. Recreational facilities
  - C. Educational facilities
  - D. Medical facilities
 are to be considered.
13. Law and taxation – the policies of the state and local bodies concerning labour laws, building codes, safety etc. are the factors that demand attention.

### Plant layout:

Plant layout means the disposition of the various facilities (equipments, material, manpower etc) and services of the plant within the area of the site selected previously.

It begins with the design of the factory building and goes up to the location and movement of a work table. All the facilities like equipments, raw materials, machinery, tools, fixtures, workers etc are given a proper place.

Plant layout is a plan of an optimum arrangement of facilities including personnel, operating equipment, storage space, material handling equipment and all other supporting services along with the design of best structure to contain all these facilities.

### Plant layout problem (Need for the plant layout):

1. Changes in the product design.
2. Changes in the volume of demand for the company's product
3. Increasing frequency of accidents because of existing layout.
4. Plant and machinery becomes outdated and is to be replaced by new one

5. Poor working environment affecting worker efficiency and productivity.
6. Change in the location or markets.
7. Minimizing the cost through effective facilities location.

**Objectives of plant layout:**

1. Material handling and transportation is minimized and efficiently controlled.
2. Bottle necks and points of congestions are eliminated so that the raw material and semi finished goods move fast from one work station to another.
3. Workstations are designed suitably and properly.
4. Suitable places are allocated to production centers and service centers.
5. Movements made by the workers are minimized.
6. Waiting time of semifinished products is minimized.
7. Working conditions are safer, better and improved.
8. Increased flexibility of changes in product design and for future expansion.
9. Utilization of cubic space (length, width and height).
10. These are improved work methods and reduced production cycle times.
11. Plant maintenance is simpler.
12. Increased productivity and better product quality with reduced capital cost.
13. A good layout permits materials to move through the plant at the desired speed with the lowest cost.

**Principle of plant layout:**

**1. Principle of integration:**

A good layout is one that integrates men, materials, machines and supporting services and other in order to get the optimum utilization of resources and maximum effectiveness.

**2. Principle of minimum movements and material handling:**

The facilities should be arranged such that the total distances travelled by the men and materials should be minimum and as far as possible straight line movement is preferred. It is better to transport materials in bulk rather than in small amounts.

**3. Principle of smooth and continuous flow :**

A good layout makes the materials to move in forward direction towards the completion stage. Bottle necks, congestion points and back tracking should be removed by proper line balancing techniques.

**4. Principle of cubic space utilization :**

The good layout utilizes both horizontal and vertical space. Besides using the floor space of a room the ceiling height is also utilized. Boxes and bags containing raw material or goods can be stacked one above the other to store more items in the same room.

5. Principle of safety and security and satisfaction :

Working places safe-well ventilated and free from dust, noise, fumes, odours, and other hazardous conditions increase the operating efficiency of the workers and improve their morale.

6. Principle of maximum flexibility :

The good layout is one that can be altered without much cost and time. The machinery is arranged in such a way that the changes of the production process can be achieved at the least cost or disturbance.

Advantage of plant layout:

1. Advantages to the worker
2. Advantages to the management
3. Advantages to manufacturing
4. Advantages to production control

Factors influencing plant layout

1. Type of production- Engg. Industry, process industry
2. Production system- Job shop, batch, mass production
3. Scale of production
4. Availability of total area
5. Arrangement of material handling system
6. Type of building- single storey, multi storey
7. Future expansion plan
8. Type of production facilities- Dedicated or general papers

Types of manufacturing system

1. Job type production:

Manufacturing of one or few quantities of products designed and produced as per specifications high variety and low volume.

2. Batch production:

Manufacture of limited no. of products produced at regular intervals and stocked at warehouse.

Ex: Chemical, pharmaceutical, assembly shops.

3. Repetitive or mass production:

Manufactures several standard products produced and stacked in the warehouses.

High volume and low variety

Ex: plastic goods, manufacture & assembly stages of automobiles

Types of layout:

## 1. Process layout (Functional layout):

The layout is recommended for batch production. All machines performing similar type of operations are grouped at one location in the process layout.

Ex – all lathes, milling machine kept at one place

The arrangements of facilities are grouped together according to their functions.

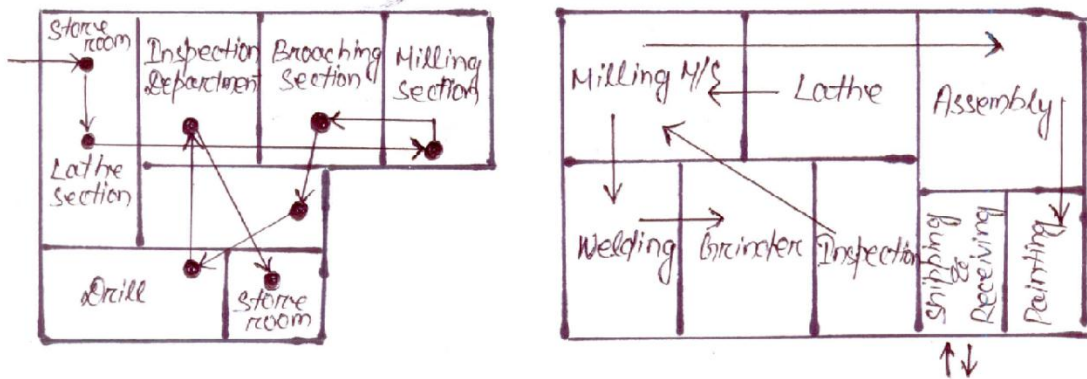

### Advantages:

- I. Wide flexibility exists during allotment of work to equipment and workers.
- II. Better utilization of equipments
- III. Lower investments on account of comparatively less no. of machine are used.
- IV. Better product quality because to attend one type of machine.
- V. Varieties of jobs coming as different job orders make the work more challenging and interesting.
- VI. Workers in one section are not affected by the nature of another section.

### Disadvantages:

- I. For the same amount of production, more space is required.
- II. Automatic material handling is difficult.
- III. More materials in process remain in queue for further operation.
- IV. Completion of same product takes more time.
- V. Work-in-process inventory is large.
- VI. Production planning and control is difficult.
- VII. Raw materials have to travel larger distances for being processed to finished goods. Thus increases cost.
- VIII. It means more inspections and efficient co-ordination.

## 2. Product layout (line layout):

The various operations on raw material are performed in a sequence and the machines are arranged in the sequence in which the raw material will be operated upon.

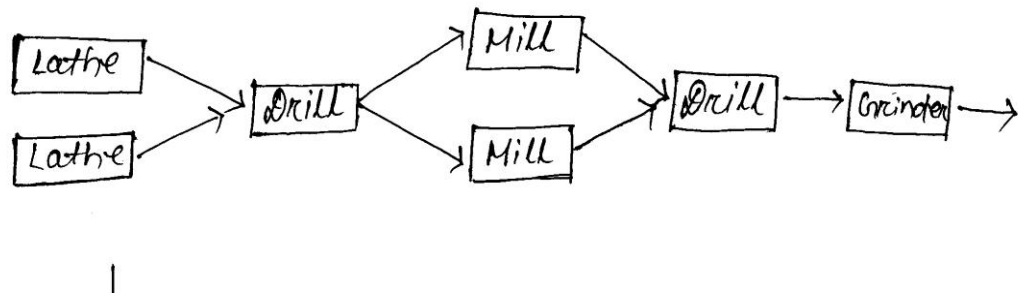

#### Advantage:

- I. Less space requirements for the same volume of production.
- II. Automatic material handling, less movements, so cost is reduced.
- III. Less in process inventory.
- IV. Product completes in lesser time.
- V. Simplified production, planning and control
- VI. Smooth and continuous work flow
- VII. Less skilled workers can learn and serve the purpose

#### Disadvantage:

- I. Lack of flexibility
- II. Excessive idle time due to slowest machine
- III. More machines to be purchased and kept which require high capital investment
- IV. One inspector has to attend a no. of machine in a production line.
- V. It is difficult to increase production beyond the capacities of the production lines.

### 3. Combination layout:

This is called the mixed type of layout usually a process layout is combined with the product layout.

Ex – refrigerator manufacturing uses a combination layout.

Manufacturing various components → process layout

For assembly of component → product layout

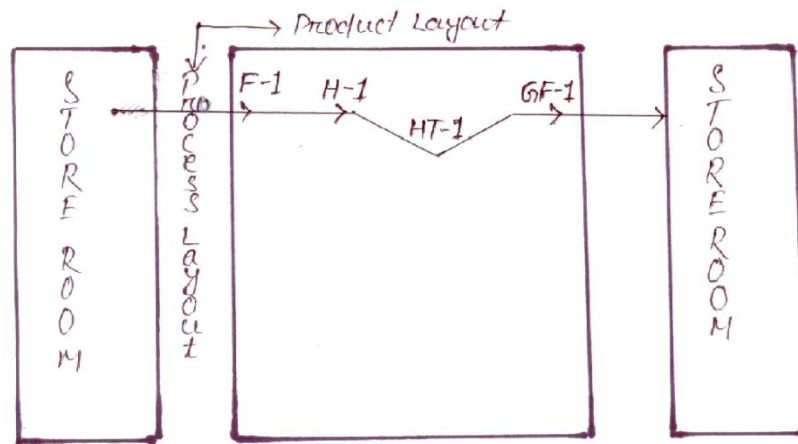

Ex – files, hacksaw, circular metal saws, wood saws.

#### 4. Fixed position layout:

This is also called the project type of layout. The materials or major components remain in a fixed location and tools, machinery, men and other materials are brought to this location.

Ex – ship building, aircraft manufacturer

##### Advantage:

- I. One or more skilled workers are engaged to one project
- II. Least movement of materials
- III. Maximum flexibility
- IV. Different projects can be taken with the same layout.

##### Disadvantages:

- I. Low content of work-in-progress
- II. Low utilization of labour and equipment
- III. High equipment handling cost

##### Plant layout procedure:

#### 1. Accumulate basic data:

Such as

- Volume and rate of production
- Product specification and bill of material
- Process sheets indicating tools, equipments, the method and the product which will be manufactured
- Flow process charts
- Standard time to complete each operation

#### 2. Analyze and co-ordinate basic data:



In order to

- The workforce size and type
- No. of workstation required
- Type of equipment required
- Storage and other space requirements
- Assembly chart and operation process chart help coordinating basic data

3. Decide equipment and machinery required:

Can be calculated by

- No. of articles to be produced
- Capacity of each equipment
- Time in which the order is to be completed

4. Select the material handling system:

Which depends upon

- Material or product to be moved
- Container in which it will be moved
- Length of movement
- Frequency of movement
- Speed of movement

5. Sketch plan of the plot:

To mark building outline, roads, storage and service etc

- The plan orientation should utilize maximum, the natural heat, light and other weather conditions.

6. Determine a general flow pattern:

- The flow pattern of materials should be such that the distance involved is least between the store and the shipping department through the production centers.
- There should be minimum back tracking
- Based upon the process or product requirement process, product or combination layout.
- Plant layout should be flexible to accommodate changes

7. Design individual workstations:

To get optimum

- Performance of operation
- Material and space utilization
- Safely and comfort of employees

8. Assemble the individual workstation layout: into total layout

9. Calculate the storage spaced required:

By knowing

- Volume of each store item

- No. of items to be kept at stores
- Time of keeping the item

10. Make flow diagrams for workstations:

And allocate them to areas on plot plan.

11. Plan and locate services areas such as offices, toilets, wash rooms, dispensary, cafeteria.

12. Make master layout by templates and models.

13. Check final layout:

- Safe and economical material handling
- Product design
- Service area
- Employee safety and comfort

14. Get official approval of the final layout about product drawings, BOM, man power requirements, estimated expenditure.

15. Install the approved layout.

Storage space requirements:

- Incoming new materials
- Checking and sorting the raw material
- Inspection of raw material
- Temporary storing the new material before it is placed at the proper location
- In process inventory
- Tools and other supplies
- Finished products

Space provided for above factors depends upon

1. Size and weight of raw material, in process goods and finished goods
2. Their quantity
3. Frequency of use

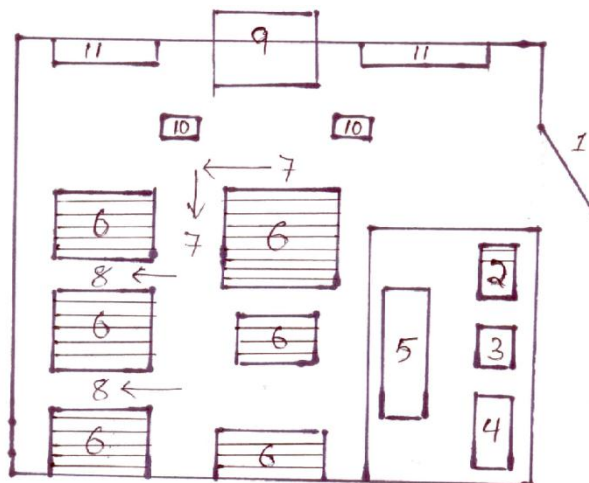

1. Incoming material receiving gate
2. Place for dumping raw material
3. Place for sorting and checking of raw material
4. Place for raw material inspection
5. Place for temporarily shorting the materials before putting them of racks.
6. Proper place for shorting each type of material
7. Main aisles
8. Side aisles
9. Service window
10. Boxes containing materials to be issued
11. Counters for keeping materials to be issued which have been brought from 6 and will be placed in 10

# INVENTORY CONTROL

## Introduction:

- In majority of the organization, cost of the material is a main part of selling price of the product. The interval between the receiving the purchased parts and transforming them into final products varies from industries to industries depending upon cycle time of manufacture.
- Materials are procured and held in the form of inventories.
- It acts as a buffer between supply and demand for efficient operation of the system.
- Stocking of anything that is tangible in order to meet the future demand is called inventory theory.

## Inventory:

- Inventory is a detailed list of those movable items which are necessary to manufacture a product and to maintain the equipment and machinery in good working order.
- It represents those items which are either stocked for sale or they are in the process of manufacturing or they are in the form of materials which are yet to be utilized.  
Ex – money kept in the shape of HSS bit MS rod milling

## Inventory control:

- It may be defined as the scientific method of finding out how much stock should be maintained in order to meet the production demands and be able to provide right type of material at right time in the right quantities and at competitive prices.
- The objectives are
  1. To minimize investment in inventory
  2. To maximize the service levels to the firm's customers and its own operating department.

## Types of inventories:

1. Raw inventories (raw materials):

- Raw materials and semifinished products supplied by another firm which are raw items for present industry.
- Raw materials are those basic unfabricated materials which have not undergone any operation since they are received from the suppliers. Ex – round bars, angles, channels, pipes etc

2. Work-in-progress inventories:

- Semifinished products at various storages of manufacturing cycle
- The items or materials in partially completed condition of manufacturing

3. Finished inventories:

They are the finished goods lying in stock rooms and waiting dispatch.

4. Indirect inventories:

- The inventories refer to those items which do not form the part or the final product but consumed in the production process.  
Eg – machine spares, oil, grease, spare parts, lubricants
- For proper operation, repair and maintenance during manufacturing cycle.

Reasons for keeping inventories:

- To stabilize production
- To take advantage of price discount
- To meet the demand during replenishment period
- To prevent loss of orders
- To keep pace with changing market conditions

Inventory control:

- Keeping track of inventory
- It is a planned approach of determining what to order, when to order and how much to order and how much to stock so that costs associated with buying and storing are optimal without interrupting production and sales.
- When should an order be placed
- How much should be ordered order quantity

Objective of inventory control:

- Purchasing material at economical price at proper time and in sufficient quantity as not to run slow
- Providing a suitable and secure storage location
- To maintain timely record of inventories of all the items
- A definite inventory identification system
- Adequate and responsible store room staff
- Suitable requisition procedure
- To provide a reserve stock

### Advantages or benefits of inventory control

- One does not face shortage of materials
- Materials of good quality and procured in time minimized defect in finished goods.
- Delays in production schedules are avoided
- Production foregets are achieved
- Accurate delivery dates
- Economy in purchasing

### Inventory control terminology:

#### 1. Demand:

It is the no. of items (products) required per unit of time. The demand may be either deterministic or probabilistic in nature.

#### 2. Order cycle:

The time period between two successive orders is called order cycle.

#### 3. Lead time:

The length of the time between placing an order and receipt of items is called lead time.

#### 4. Safety stock:

It is also called buffer stock or minimum stock. It is the stock or inventory needed to account for delays in materials supply and to account for sudden increase in demand due to rush orders.

#### 5. Inventory turnover:

If the company maintains inventories equal to 3 months consumption it means that inventory turnover is 4 times a year i.e. the entire inventory is used up and replaced 4 times a year.

#### 6. Reorder level:

It is the point at which the replenishment action is initiated. When the stock level reaches ROL the order is placed for the item.

## 7. Reorder quantity:

This is the quantity of material to be ordered at the reorder level. This quantity equals to the EOQ.

### Cost associated with inventory

#### 1. Purchase (or production) cost:

The value of an item is its unit purchasing or production cost.

#### 2. Capital cost:

The amount invested in an item is an amount of capital not available for other purchases.

#### 3. Ordering cost:

It is also known as procurement cost or replenishment cost or acquisition cost.

Two type of costs- Fixed costs and variable costs.

Fixed costs don't depend on the no. of orders whereas variable costs change w. r. t the no. of orders placed.

##### I. Purchasing:

The clerical and administrative cost associated with the purchasing, the cost of requisition material, placing the order, follow up, receiving and evaluating quotations.

##### II. Inspection:

The cost of checking material after they are received by the supplier for quantity and quality and maintaining records of the receipts.

##### III. Accounting:

The cost of checking supply against a given level of hand and this cost vary in direct proportion to the amount of holding and period of holding the stock in stores.

This includes-

- I. Storage costs (rent, heating, lighting etc.)
- II. Handling costs (associated with moving the items. Such as labour cost, equipment for handling)
- III. Depreciation, taxes and insurance
- IV. Product deterioration and obsolescence
- V. Spoilage, breakage

### Economic order quantity:

How much materials may be ordered at a time. An industry making bolts will definitely like to know the length of steel bars to be purchased at any one time. i.e. called EOQ.

An economic order quantity is one which permits lowest cost per unit and is most advantageous.

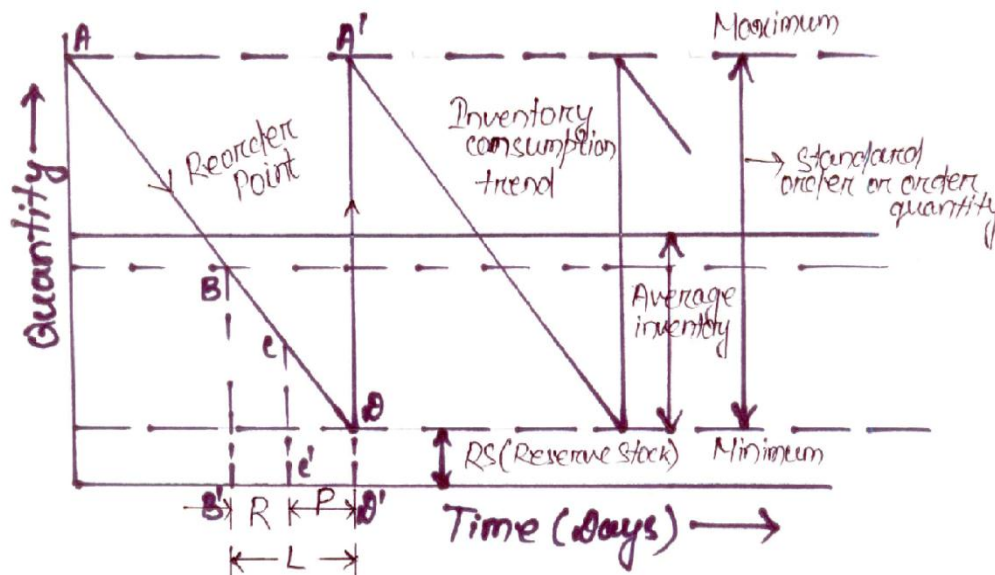

Starting from an instant when inventory OA is in the stores, it consumes gradually in quantity from A along AD at a uniform rate. We know it takes L no. of days between initiating order and receiving the required inventory. As quantity reaches point B, purchase requisition is initiated which takes from B to C that is time R. from C to D is the procurement time P. At the point D when only resource stock is left, the ordered material is supposed to reach and again the total quantity shoots to its maximum value i.e. the point A'(A=A')

**Maximum quantity**- OA is the upper or max limit to which the inventory can be kept in the stores at any time.

**Minimum quantity**- OE is the lower or minimum limit of the inventory which must be kept in the stores at any time.

**Standard order (A'D)** - It is the difference between maximum and minimum quantity and is known as economical purchase inventory size.

**Reorder point (B)**- It indicates that it is high time to initiate a purchase order if not done so the inventory may exhaust, even reserve stock utilized before the new material arrives.



From B' to D' it is lead time and it may be calculated on the basis of past experience.

It includes-

- a) Time to prepare purchase requisition and placing the order.
- b) Time taken to deliver purchase order to the seller
- c) Time for seller to get or prepare inventory
- d) Time for inventory to be dispatched from the vendor's end and to reach the customer

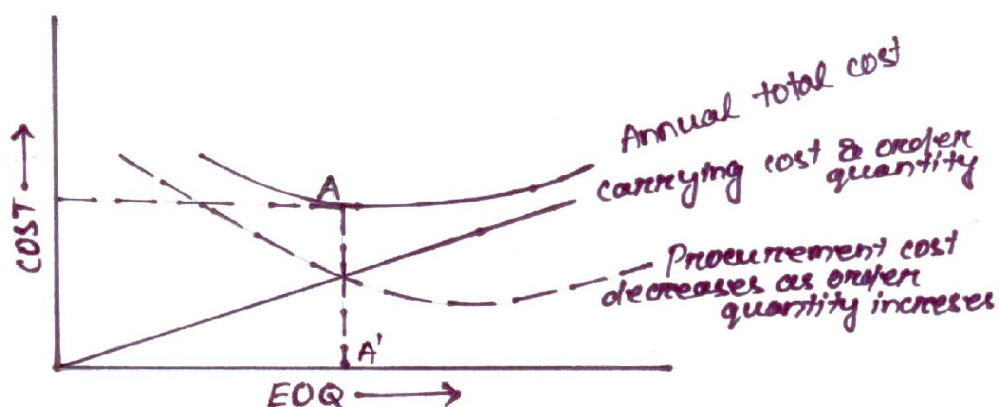

### Inventory procurement cost:

1. Receiving quotations
2. Processing purchase requisition
3. Following up and expediting purchase order
4. Receiving material and then inspect it
5. Processing seller's invoice

Procurement cost decrease as order quantity increases.

### Inventory carrying cost:

1. Interest on capital investment
2. Cost of storage facility, up-keep of material, record keeping
3. Cost involving deterioration and obsolescence
4. Cost of insurance, property tax.

Carrying cost directly proportional to the order size or order quantity

Mathematical derivation of EOQ:

Let Q is the economic lot size or EOQ

C is the cost for one item.

I is the cost of carrying inventory in percentage per period

P is the procurement cost associated with one order

U is the total quantity used per period.

$$\text{No. of purchase orders to be furnished} = \frac{\text{Total quantity}}{\text{EOQ}} = \frac{U}{Q}$$

Total procurement cost = No. of orders × cost involved in one order

$$= \frac{U}{Q} \times P$$

Average quantity = Q/2

Inventory carrying cost = average inventory × cost per item × cost of carrying inventory in %

$$= \frac{Q}{2} \times C \times I$$

Total cost (T) = a + b

$$= \frac{U}{Q} \times P + \frac{Q}{2} \times C \times I$$

To minimize cost,  $\frac{dT}{dQ} = 0$

$$\Rightarrow \frac{d}{dQ} \left( \frac{U}{Q} P + \frac{Q}{2} CI \right) = 0$$

$$\Rightarrow -UQ^{-2}P + CI/2 = 0$$

$$\Rightarrow Q^2 = \frac{2UP}{CI}$$

$$\Rightarrow Q = \sqrt{\frac{2UP}{CI}}$$

**Problem-1:**

- I. Annual usage (U) = 60 units
  - II. Procurement cost (P) = Rs 15
  - III. Cost per price (C) = Rs 100
  - IV. Cost of carrying inventory (I) = 10 %
- Calculate EOQ.

**Answer:**

$$Q = \sqrt{\frac{2UP}{CI}}$$

$$= \sqrt{\frac{2 \times 60 \times 15 \times 100}{100 \times 10}} = 13.41$$

$$\text{No. of orders per year} = \frac{60}{13.41} = 4.47 \cong 5$$

$$\therefore \text{EOQ} = \frac{60}{5} = 12 \text{ units (rounded)}$$

**Problem-2:**

The rate of use of a particular raw material from stores is 20 units per year. The cost of placing and receiving on order is Rs 40. The cost of each unit is Rs 100. The cost of carrying inventory in percent per year is 0.16 and it depends upon the average stock. Determine the order quantity. If the lead time is 3 month, calculate the reorder point.

**Answer:**

$$U = 20 \text{ units}$$

$$P = \text{Rs } 40 \text{ /-}$$

$$C = \text{Rs } 100 \text{ /-}$$

$$I = 0.16$$

$$\text{EOQ} = \sqrt{\frac{2UP}{CI}} = \sqrt{\frac{2 \times 20 \times 40}{100 \times 0.16}} = 10$$

$$L = 3 \text{ months}$$

12 months = 20 units

$$3 \text{ months} = \frac{20}{12} \times 3 = 5 \text{ units}$$

Problem-3:

Find economic order quantity from following data.

Average annual demand = 30000 units

Inventory carrying cost = 12 % of the unit value per year

Cost of unit = Rs 2 /-

Answer:

Given, U = 30000

$$I = 12 \%$$

$$P = 70$$

$$C = 2 \text{ /-}$$

$$EOQ = \sqrt{\frac{2UP}{CI}} = \sqrt{\frac{2 \times 30000 \times 70 \times 100}{2 \times 12}} = 4183.3$$

$$\text{No. of orders} = \frac{30000}{4183.3} = 7.17 \cong 7$$

$$EOQ = \frac{30000}{7} = 4285.7 \cong 4286 \text{ (rounded)}$$

ABC analysis:

ABC analysis helps differentiating the item from one another and tells how much valued the item is and controlling it to what extent is in the interest of an organization.

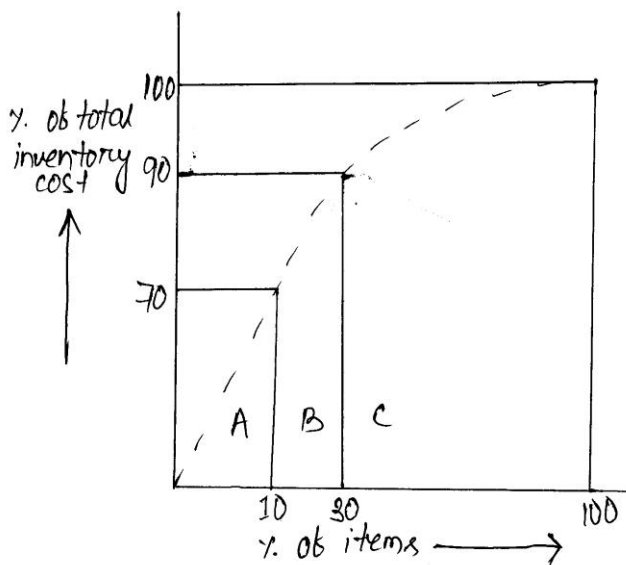

1. A-items:

A items are high valued but are limited or few in number. They need careful and close inventory control and proper handling and storage facilities should be provided for them.

A items generally 70-80 % of the total inventory cost and 10 % of the total items.

2. B-items;

B-items are medium valued and their number lies in between A and C items. They need moderate control. They are purchased on the basis of past requirements.

B-items generally 20-15 % of total inventory cost and 15-20 % of the total items.

3. C-items:

C-items are low valued, but maximum numbered items. These items do not need any control. These are least important items, like clip, all pins, washers, rubber bands. No record keeping is done.

C-items generally 10-5 % of the total inventory cost and constitute 75 % of the total items

### Advantage

- I. Better planning and control
- II. Increase inventory turn over
- III. Effective management and control

### Disadvantage

- I. Periodic review to be dfdf

### Procedure

1. Identify all the items used In industry
2. List all the items as per their value.
3. Count the no. of high valued, medium valued and low valued items
4. Find the % of high, medium and low valued items  
High valued contribute – 70% of total inv. Cost  
Medium valued contribute -20% of total inv. Cost  
Low valued contribute-10% of total inv. Cost
5. A graph can be plotted between % of items and % of total inventory cost

# Production planning and control

Production –Production are manufactured by the transformation of raw material into finished goods

Planning- planning looks ahead, anticipates possible difficulties and decides in advance as to how the production is to be carried out.

Control- the control phase makes sure that programmed production is constantly maintained

## Need for PPC-

- To achieve effective utilization of firms resources
- To achieve the production objectives with respect to quality, quantity, cost and timeliness of delivery.
- To obtain the uninterrupted production flow in order to meet customers demand w.r.t quality and committed delivery schedule.
- To help the company to supply a good quality products to the customer on the continuous basis at competitive rates

## Objectives of PPC-

- Systematic planning of production activities to achieve the highest efficiency in production of goods
- To organize the production facilities like machines, men, etc. to achieve stated production objectives
- Optimum scheduling of resources
- To confirm to delivery commitments
- Materials planning & control
- To be able to make adjustments due to changes in demand and rush orders

## Functions of production planning & control

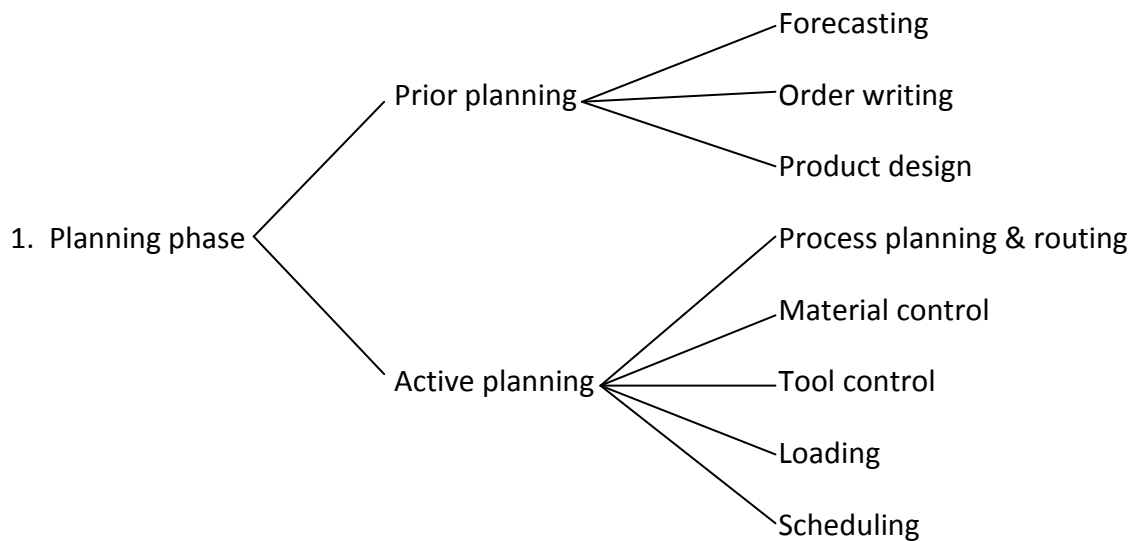

2. Action phase ----- Dispatching

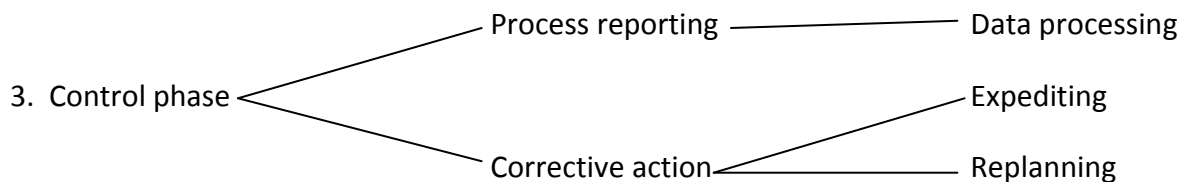

- a) Forecasting- estimation of type, quantity and quality of future work.
- b) Order writing- giving authority to one or more persons to undertake a particular job.
- c) Product design- collection of information regarding specifications, bill of materials, drawings etc.
- d) Process planning & routing- finding the most economical process of doing a work and then deciding how & where the work will be done
- e) Material control- it involves determining the requirements and control of materials
- f) Tool control- it involves determining the requirement and control of tools used
- g) Loading- assignment of work to manpower machinery etc.



- h) Scheduling- it is the time phase of loading & determines when and in what sequence the work will be required out. It fixes the starting as well as the finishing time for the job
- i) Dispatching- it is the transition from planning to action phase. In this phase the worker is ordered to start the actual work.
- j) Progress reporting- Data regarding the job progress is collected.  
-It is interpreted by comparison with the preset level of performance.
- k) Corrective action- 1. Expanding means taking action if the progress reporting indicates deviation of the plan from the originally set targets  
2. Replanning of the whole affair becomes essential, in case expediting fails to bring the deviated plan to its actual path

## Process planning-

### Definition and concept

- Process planning means the preparation of work detail plan
- Since a process is required to manufacture a product, it is necessary to plan the process
- PP is determining the most economical method of performing an operation or activity
- Process planning comes after it has been decided as what is to be made
- Process planning develops the broad plan of manufacture for the component or product
- Process planning takes as its input the drawings or other specifications which show what is to be made and forecasts or orders which indicate the product quantity to be manufactured

### Information required to do process planning-

- Quantity of work to be done along with product specification
- Quality of work to be completed
- Availability of equipments, tools and personnel etc.
- Sequence in which operations will be performed on the raw material
- Names of equipments on which the operations will be performed
- Standard time for each operation
- When the operations will be performed

### Process planning procedure-

## 1. Selection of process

- a process is necessary in order to shape, form, condition and join materials and components with the help of machines and labour in order to convert raw material into a finished product.
- One should select the most economical process and sequence that satisfies the product specifications
- The selection of process depends upon

### a) Current production commitments-

Its enough work has already been allocated to more efficient equipments, the current work may have to be passed on to less efficient m/c s to complete the same in time

### b) Delivery date-

- an early delivery date may
- force the use of less efficient m/c s
- rule out the use of special tools & jigs as they will take time for design and fabrication

c) quantity to be produced- Small quantity will not probably justify the high cost of preparation and efficient set-ups. Thus, they may have to be made on less efficient machines and vice-versa.

d) Quality standards- Quality standards may limit the choice of making the product on a particular machine

## 2. Selection of material-

- Material should be of right quality and chemical composition as per the product specifications
- Shape and size of material should restrict the scrap(i.e. material removed for getting the product shape)

## 3. Selection of jigs, fixtures and other special attachments

These supporting devices are necessary

- To give higher production rate
- To reduce cost of production per piece

## 4. Selection of cutting tools and inspection gauges-

- Reduce production time
- Inspect accurately and at a faster rate

5. Make the process layout indicating every operation and the sequence in which each operation is to be carried out

6. Find set-up time and standard time for each operation

7. Manifest process planning by documents such as operation and route sheets, which gives information about the operations required, the preferred sequence of operations, auxiliary tools required estimated operation times

### Routing

- taking from raw material to the finished product, routing decides the path and sequence of operations to be performed on the job from one machine to another
- it determines what work is to be done and where and how it will be done

### procedure

- the finished product is analysed from the manufacturing stand point in order to decide how many components can be made in the plant and how many others will be purchased from the outside through vendors, by sub contracting etc. make/buy decisions depends upon the work load in the plant, availability of equipment and personnel to manufacture all components and the economy associated with making all components within the plant itself
- A parts list and a BOM is prepared showing name of the part, quantity, material specifications amount of materials required etc. The necessary materials thus can be produced
- From production standards m/c capacities, m/c characteristics and the operations which must be performed at each stage of manufacture are established and listed in proper sequence on an operation and route sheet. the place of operations is also decided
- Operation and route sheet are separate. An operation sheet shows every thing about the operation, i.e. operation description, their sequence, type of machinery, tools, setup and operation times, where as a route sheet besides listing the sequence of operations and relation between operation and machine, also details the section and the m/c to whom the work will flow

Operation and route sheet								
Component No. _____					Drawing _____			
Name of component _____					Quality _____			
Material _____					To be completed on _____			
Routing		Operation No.	Operation description	Tools required	Fixtures	Time		
Section	Machine					Set up	Operation	total

The difference between an operation sheet and a route sheet is that an operation sheet remains same for the components if the order is repeated but the route sheet may have to be revised if certain machines are already committed to other jobs.

- The next step is to determine the lot size or the number of components to be manufactured in one lot or batch.
- Standard scrap factors and the places where scrap is very likely occur are identified causes for points out of control limits are explored and corrected. The variables like workers, machinery and schedules may adjust to minimize scrap.
- The cost of the component is analyzed and estimated through the information obtain in steps. The costs consist of material and labour charges and other specific and general indirect expenses.

Scheduling:

- Scheduling means when and in what sequence the work will be done. It involves deciding as to when the work will start and in a certain duration of time how much work will be finished.
- It determines which order will be taken up on which machine and in which department by which operator.

## Scheduling procedure and techniques:

### Master schedule:

Master schedule for the foundry shop Maximum production – 100 Hr Minimum production – 8 Hr			
Week-1	Week-2	Week-3	Week-4
15	15	20	15
25	25	12	10
20	28	32	
35			

- A master schedule resembles central office which possesses information about all the orders in hand.
- As the orders are received, depending upon their delivery dates they are worked on the master schedule when the shop capacity is full for the present week the newly acquired orders are carried over to due next week and so on.
- A master schedule updated continuously.

### Advantages:

- It is simple and easy to understand.
- It can be kept current.
- It involves less cost to make it and maintain.
- It can be maintained by non-technical staff.
- A certain percentage of total weekly capacity can be allocated for rush orders.

### Disadvantages:

- It provides only overall picture.
- It does not give detailed information.

### Applications:

- For the purpose of loading the entire plant.
- In research and development organizations.
- For the overall planning in foundries, computer entries, repair shops etc.

## Scheduling technique:

### a) Perpetual schedule:

It is similar to master scheduling. It is simple and easy to understand. It involves less cost and can be maintained by clerical staff. The information is not clear when work will take place.

- i. Preparation of load analysis sheet from the orders in hand.

LOAD ANALYSIS SHEET			
	LOAD IN Hr/DAYS		
ORDER No.	SEC A	SEC B	SEC C
X-320	25	10	16
Y-210	10	15	10
Y-314	18	20	8
Z-150	8	25	-----
.	.	.	.
.	.	.	.
.	.	.	.
.	.	.	.
.	.	.	.

- ii. Weekly capacity of section is calculated by adding total load against each section.

GANIT LOAD CHART				
	WEEK 1	WEEK 2	WEEK 3	WEEK 4
SEC A				
SEC B				
SEC C				

Color bars are shows the actual work load against each section.

Dispatching:

- Dispatching is the physical handing over of a manufacturing order to the operating facility through the release of orders and instructions previously developed plan of activity (time and sequence) established by the scheduling section of the production planning and control department.
- Dispatcher transmits orders to the various shops.
- Dispatcher determines by whom the job shall be done and it coordinates production.
- It creates a direct link between production and sales.

## Procedure:

The product is broken into different components and components into operations. A route sheet for the part C having three operations on it is shown.

ROUTE SHEET PART C
MATERIAL
OPERATION-1
OPERATION-2
OPERATION-3

- a) Store issue order:  
Authorize stores to deliver required raw material.
- b) Tool order:  
Authorize tool store to release the necessary tools. The tools can be collected by the tool room attendant.
- c) Job order:  
Instruct the worker to proceed with the operations and forms the basis for worker's pay.
- d) Time ticket:  
It records the beginning and ending time of the operations and forms the basis for worker's pay.
- e) Inspection order:  
Notify the inspectors to carry out necessary inspections and report the quality of the component.
- f) Move order:  
Authorized the movement of materials and components from one facility to another for further operations.

## Process control:

It means trying to achieve the standards set i.e. a certain level of efficiency or a certain volume of production in a specified duration. The system of progress control should be such that it furnishes timely, adequate and accurate information about the progress made, delays and under or overloading.

Steps:

- a) Setting up a system to watch and record the progress of the operating facility.
- b) Making a report of the work progress or work accomplishment.
- c) Transmission of report to
  - i. Control group for necessary control action
  - ii. Accounting group for recording material and labour expenditures.
- d) Interpretation of the information contained in the progress report by the control group.
- e) Taking corrective action if necessary.



## ESTIMATING AND COSTING

Cost- Cost may be defined as the amount of expenditure incurred on a given thing.

Or

Cost is the amount of resources sacrificed or given up to achieve a specific objective which may be the acquisition of goods or services.

Accounting- may be defined as the art and science of recording business transaction in a methodical manner. So as to show

- I. The true state of affairs of a business at a particular instant of time.
- II. The deficiency or surplus which has accrued during a specific time period.

Cost accounting (costing)-

It may be defined as the process of accounting for cost from the point at which expenditure is incurred to the establishment of its relationship with cost centers and cost units.

Costing is the operation of calculating the cost of an article (for sale) as a basis to fix its selling price. It implies the techniques and processes of ascertaining costs of given things or items

Costing involves-

- I. Classifying, recording and appropriate allocation of expenditure
- II. The relation of these costs to sales values
- III. To ascertainment of profitability

Cost centers-

A person, location or an equipment for which costs may be ascertained and used for the purposes of cost control

Cost unit- A unit or quantity of product, service or time in relation to which costs may be ascertained.

Necessary of costing because it given information for,

- I. Determining, classifying and analyzing the cost and income of a business enterprise.
- II. Determining the prices to be quoted to customers.
- III. Forming basis for managerial decisions
  - a) Make or buy
  - b) To introduce or drop an existing
  - c) To sell or to drop
- IV. Cost control
- V. Profitability of products
- VI. Budgeting
- VII. Continuation of business
- VIII. Proper matching of cost with revenue

### Elements of cost-

The cost of an industrial enterprise may be divided into three principles of elements

1. Material
2. Labour
3. Expense

#### 1. Material cost-

It is the cost of commodities supplied to an undertaking. It is of two types

- a) Direct material cost
- b) Indirect material cost

#### a) Direct material cost-

- A direct material is one which goes into a salable product or its use is directly essential for the completion of that product.

Ex. H.S.S bit for making a turning tool for later.

- The amount paid for or the money spent on direct materials is known as direct material cost.

#### 2. Labour cost-

It is the cost of remuneration (wages, salaries, commissions, bonuses etc.) of the employees of a concern or enterprise. It is also two types.

- a) Direct labour cost
- b) Indirect labour cost

#### a) Direct labour cost-

- The direct labour cost is the cost of labour that can be identified directly with the manufacture of the product.
- A direct labour is one who converts the direct material into salable products, the wages of such employees constitute direct labour cost.

b) Indirect labour cost-

The is the cost of the labour that does not alter the construction, conformation, composition or condition of the direct material but is necessary for the progressive movement and handling of the product to the point of dispatch.

Ex. Maintenance men, helpers, machine setters, supervisors and foremen.

3. Expense-

- It refers to all charges other than those incurred as direct labour and materials
- The costs of the services provided to an undertaking and the cost of use of owned assets

a) Direct expenses-

- Cost of special layouts, designs or drawings produced for a specific job are direct expenses of a job
- Layouts, designs or drawings are totally consumed on the job
- Hire up special or single purpose machine tools or other equipments for completing a particular production order.

b) Indirect expenses-

There are the expenses which cannot be allocated but can be apportioned to cost centers

Ex. Rent of the building, insurance premium, telephone bill etc.

Fixed expenses

The costs that tend to remain relatively constant regardless of the volume of production.

Ex. Taxes on land and building, rent

Variable expanses

Variable expenses are those which tend to vary directly with the volume of production.

Ex. Royalties paid on a volume basis (as in case of gramophone records)

## Nature of cost (Classification based on Activity or volume)

### a) Fixed cost (policy cost or period cost)

The costs which tend to remain constant irrespective of the volume of output or sales

Ex. staff salaries, administration expenses, rent and establishment charges, depreciation etc. insurance

It is expressed in terms of time period .i.e. per day, per annum etc.

### b) Variable costs-

Variable costs tend to vary directly with the volume of output.

Ex. Direct productive labour, direct materials, direct expenses

### c) Semi variable costs-

- These costs are partly fixed and partly variable
- Seminar able costs vary with changes in output but the variation is irregular  
Ex. Indirect hourly labour, wages of maintenance men, grease and oil, water and electricity etc.

## Prime cost

Prime cost = direct material + direct labour cost + direct expenses

Factory cost = prime cost + factory overhead

=direct material cost + direct labour cost + direct expenses + factory overhead  
(production overhead) (indirect mat. + in. lab + in. expenses)

Total cost = factory cost + selling overhead + distribution overhead + administration overhead

Selling price of a product = total cost + profit or total cost – loss

## Over head-

- Indirect costs, overheads, on cost and burden
- Overheads are all expenses other than direct expenses
- Overhead is defined as the cost of indirect material, indirect labour and other indirect expenses including services, which cannot be charged direct to specific cost units.

Over head may be divided into

- Production or manufacturing overhead
- Administration overhead
- Selling overhead
- Distribution overhead
- R & D overhead

a) Production or manufacturing overhead-

- It includes all indirect expenses incurred by the concern from the receipt of the production order until its completion. i.e. being ready for dispatch to the customer.
- Typical manufacturing overhead costs are
  1. Building expenses- Rent
    - Insurance
    - Repairs
    - Heating and lighting
    - Depreciation
  2. Indirect labour- supervisors and foremen
    - Machine setters
    - General workers
    - Maintenance
    - Shop clerk shop inspector
  3. Water, fuel and power
  4. Consumable stores such as cotton waste, grease etc.
  5. Plant maintenance and depreciation
  6. Sundry expense such as
    - Employment office
    - Security
    - Revelation and rest rooms etc.

b) Administration overhead-

- Administration overhead consists of expenses incurred in the direction, control and administration of an enterprises

- Administration overhead is the expense of providing a general management and clerical service.
- Examples- office rent, salaries and wages of clerks, legal costs, rates and taxes, postage and telephones, audit fees, bank charges etc.

c) Selling overhead-

- Selling overhead consists of expenses in order to maintain and increase the volume of sales
- Selling overhead covers all expenses direct or indirect which are necessary to persuade consumers to buy
- Examples- advertising, salaries and commissions of sales managers, travelers and agents, rent of sales-rooms and offices, consumer services and service after sales etc.

d) Distribution overhead-

- Distribution overhead covers all expenses connected with transporting products to customers and storing them when necessary.
- Examples- warehouse charges, cost of transporting goods, loading and unloading charges, upkeep and running of delivery vehicles, salaries of clerks and labourers, depreciation etc.

e) Research and development overhead

- Depends upon the nature of product or service being produced
- R & D overhead is proportional to the size of R & D department

Selling price of a product

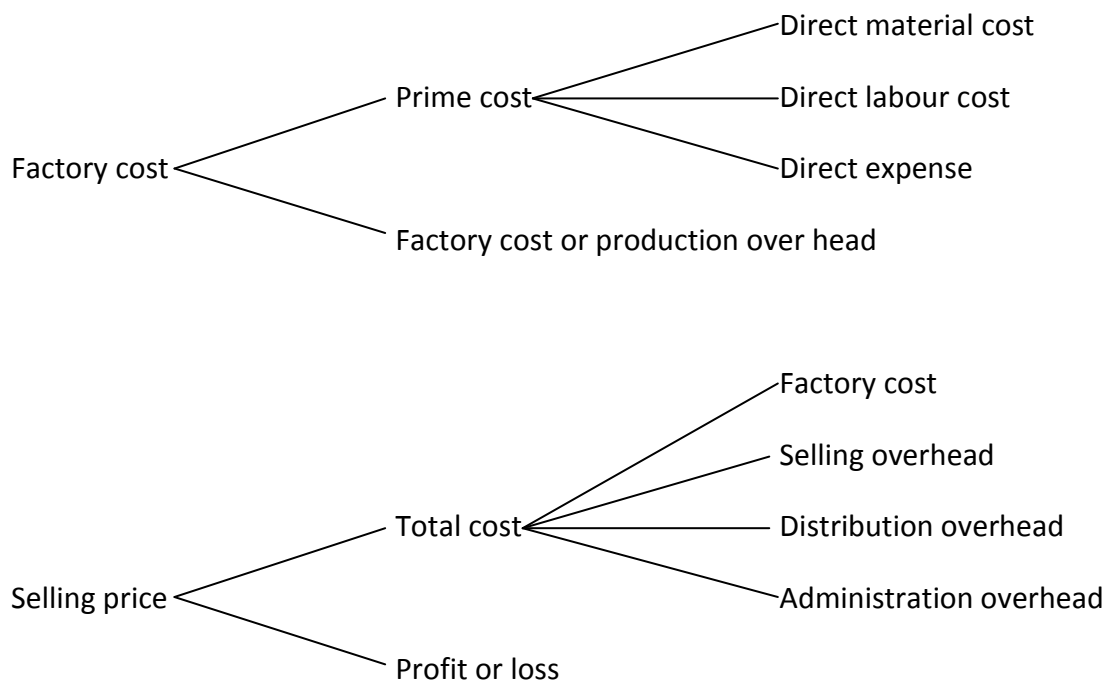

### Process cost-

- It is the cost for each, of a number of distinct stages or process which are performed to make a product
- The total time spent and materials used on each process, as well as services such as power, light and heating are all charged in calculating the process cost for this purpose a process cost sheet is used
- Process costs are usually applied in industries, where the final product has passed through a no. of distinct stages or processes for ex. In textile mills, gas, chemical and paper mills
- An imp objective in process costing is the evaluation of wastage

### Cost of production-

- It is the cost of the sequence of operations which begins with supplying materials, labour and services and ends with primary packing of product

# PLANT MAINTENANCE

## Plant-

A plant is a place, where men, materials, money, equipment, machinery, etc are brought together for manufacturing products.

## Maintenance-

Maintenance of facilities and equipment in good working condition is essential to achieve specified level of quality and reliability and efficient working. It helps in maintaining and increasing the operational efficiency of plant facilities and contributes to revenue by reducing operating of production.

## Objectives of plant maintenance-

- To achieve minimum breakdown and to keep the plant in good working condition at the lowest possible cost.
- To keep the m/c in such a condition that permit to use without any interrupter
- To increase functional reliability of production facilities
- To maximize the useful life of the equipment
- To minimize the frequency of interruption to production by reducing breakdown
- To enhance the safety of manpower

## IMP of maintenance-

- Equipment breakdown leads to an inevitable loss of production
- An improperly maintained or neglected plant will sooner or later require expensive and frequent repairs, because with the passage of time all machines or other facilities, building, etc wear out and need to be maintained to function properly.
- Plant maintenance plays a prominent in production management because plant breakdown creates problem such as- loss of production time
  - ✓ Rescheduling of production
  - ✓ Spoilt materials (because sudden stoppage of process damages in-process materials)
  - ✓ Failure to recover overheads (because loss in production hours)
  - ✓ Need for overtime
  - ✓ Need for subcontracting work
  - ✓ Temporary work shortage- workers require alteration work



## Duties, functions and responsibilities of plant maintenance department-

### a) Inspection-

- Inspection is concerned with the routine schedule checks of the plant facilities to examine their condition and to check for needed repairs
- Inspection ensures the safe and efficient operation of equipment and machinery
- Frequency of inspections depends upon the intensity of the use of the equipment
- Items removed during maintenance and overhaul operation are inspected to determine flexibility of repairs
- Maintenance items received from vendors are inspected for their fitness

### b) Engineering-

- Engineering involves alterations and improvements in existing equipments and building to minimize breakdowns
- Maintenance department also undertakes engineering and supervision of constructional projects that will eventually become part of the plant.
- Engineering and consulting services to production supervision are also the responsibility of maintenance department.

### c) Maintenance –

- Maintenance of existing plant equipment.
- Maintenance of existing plant buildings and other service facilities such as yards, central stress, roadways.
- Minor installation of equipments, building and replacements
- Prevent breakdown by well-conceived plans of inspection, lubrication, adjustments, repair and overhaul.

### d) Repair-

- Maintenance department carries corrective repairs to avoid unsatisfactory conditions found during preventive maintenance inspection.
- Such a repair work is of an emergency nature and is necessary to correct breakdowns.

e) Overhaul-

- Overhaul is a planned, schedule reconditioning of plant facilities such as machinery etc.
- It involves replacement, reconditioning, reassembly etc.

f) Construction-

- In some organizations, maintenance department is provided with equipment and personnel and it takes up construction job also.
- It handles construction of wood, brick and steel structures, electrical installation etc.

g) Salvage-

- It may also handle disposition of scrap or surplus materials.
- This involves segregation and disposition of production scrap.

h) Clerical jobs-

- Maintenance department keeps records of cost, of time progress on jobs, electrical installations, water, steams, air and oil lines, transport facilities.
- i) Generation and distribution of power.
- j) Providing plant protection
- k) Establishing and maintaining a suitable store of maintenance materials
- l) House keeping
- m) Pollution and noise control

Types of maintenance:

Maintenance may be classified as

- a) Corrective or breakdown maintenance
- b) Scheduled maintenance
- c) Preventive maintenance
- d) Predictive maintenance

a) Corrective or breakdown maintenance:

- Corrective or breakdown maintenance implies that repairs are made after the equipment is out of order and it cannot perform its normal function any longer. Ex – electric motor will not start, a belt is broken.
- Under such conditions, production department calls on the maintenance department to rectify the defect. The maintenance department checks into the difficulty and makes the necessary repairs.
- After removing the fault, maintenance engineers do not attend the equipment again until another failure or breakdown occurs.
- Breakdown maintenance is economical for those equipment whose down time and repair costs are less.
- Breakdown type maintenance involves little administrative work, few records and comparative small staff.

Causes of equipment breakdown:

- Lack of lubrication
- Neglected cooling system
- Failure to replace worn out parts
- External factors (too high or too voltage)

Disadvantages of breakdown maintenance:

- Breakdowns occur at inopportune times, which lead to poor, hurried maintenance and excessive delays in production.
- Reduction of output
- More spoiled material
- Increased chances of accidents and less safety to both workers and machines
- Direct loss of profit.
- Breakdown maintenance cannot be employed to cranes, lifts, hoists and pressure vessels.

b) Scheduled maintenance:

- Scheduled maintenance is a stick-in-time procedure aimed at averting breakdowns
- Scheduled maintenance do inspection, lubrication, repair and overhaul of certain equipments are done in predetermined schedule.
- Schedule maintenance practice is generally followed for overhauling of machines, cleaning of water and other tanks, white washing of building etc.

c) Preventive maintenance:

- A system of scheduled, planned or preventive maintenance tries to minimize the problems of breakdown maintenance.
- It is a stitch-in-time procedure.
- It locates weak spots (such as bearing surfaces, parts under excessive vibrations etc) in all equipments, proceeds them regular inspection and minor repairs reducing the danger of unanticipated breakdown.
- Preventive maintenance involves.
- Periodic inspection of equipment and machinery to prevent production breakdown an harmful depreciation.
- Upkeep of plant equipment to correct fault.

Objective of FM:

- To minimize the possibility of unanticipated production interruption and major breakdown by locating the fault.
- To make plant equipment and machinery ready to use
- To maintain the optimum productive efficiency
- To maintain the operational accuracy
- To achieve maximum production and minimum repair cost
- To ensure safety of life and limbs of the workers

Advantages:

- Reduces breakdown and down-time
- Lesser odd-time repairs
- Greater safety for workers
- Low maintenance and repair cost
- Increased equipment life.
- Better product quality.

d) Predictive maintenance:

- It is a newer maintenance technique.
- It uses human senses or other sensitive instruments such as audio gauges, vibration analysers, amplitude meters, pressure, temperature and resistance strain gauges to predict troubles before the equipment fails.
- Unusual sound coming out of a rotating equipment predict an trouble, an electric cable excessively hot at one point predicts an trouble.
- In predictive maintenance, equipment conditions are measured periodically or on a continuous basis enables maintenance men to take timely action such as equipment adjustments, repair and overhaul.

- It extends the service life of an equipment without fear of failure.

### Recent developments in plant maintenance:

The management techniques used for plant maintenance to increase maintenance efficiency, reduce maintenance cost and to improve services.

#### A. Use of work study:

Work study can improve maintenance scheduling and eliminate a great deal of frustration and anxiety on the part of production supervision.

#### B. Use of network planning techniques:

- CPM has enables some firms to cut their down time by 20 to 30 %
- Maintenance costs have been cut down.
- CPM is useful for large maintenance projects
- 70 % of reduction in time for overhaul by central electricity board in Great Britain using network planning technique.
- PERT reduced shut down time 18 to 16 days 102 and added 90000 barrels to production volume of a refinery.

#### C. Use of operation research:

Operation research handles maintenance problems such as the economical level of spare parts or when to replace an item etc.

#### D. Use of computers;

- More efficient and control over maintenance problems.
- Computer can prepare maintenance work orders giving accurate work order descriptions and job timing.
- Eliminate human error in preparing work order.
- Reduced cost of keeping records of equipments
- Reduced premature replacement of parts.